



00559

Explore the World of LGB

Interim PDF Edition

The popular 00559 “Explore the World of LGB” guide book was originally published in 1998 and is now out of production. An updated guide book will be offered in 2005 with information on the latest LGB products, but to assist our customers until the updated guide book is available, we have produced this interim Adobe Acrobat PDF edition of the printed 00559.



IMPORTANT NOTES:

- Because of the production techniques used in 1998, **this interim PDF edition does not have all of the graphics included in the printed 00559.** To reduce download times, all of the graphics in this interim PDF edition are low resolution.
- **Several products mentioned the printed 00559 and this interim PDF edition have been replaced or discontinued.** For example, the 12030 EPL Supplementary Switch has been replaced by the functionally identical 12070. Visit www.lgb.com for the latest product information.
- **Many new products have been added to the LGB program.** For example, a series of ultra-wide radius “R5” track sections have been added. Also, many new products have been added to the LGB Multi-Train System. Again, visit www.lgb.com for the latest product information.
- **The chapter on the LGB Multi-Train System is now obsolete and has been deleted from this interim PDF edition.** Visit www.lgb.com and click on the “MTS” button for more information on the LGB Multi-Train System.
- **This interim PDF edition is provided for personal use only.** It may not be reproduced or distributed in any way without the written consent of Ernst Paul Lehmann Patentwerk.

Products, specifications and availability dates are subject to change without notice. Some products are not available in all markets and at all retailers. Some products shown are pre-production prototypes. LGB, RIGI, GNOMY, LGB of America, LEHMANN and the LGB TOYTRAIN logotype are registered trademarks of Ernst Paul Lehmann Patentwerk, Germany. Other trademarks are the property of their owners. © 2004 Ernst Paul Lehmann Patentwerk.

EXPLORE THE WORLD OF LGB

Answers to Your LGB Questions

Publisher: Ernst Paul Lehmann Patentwerk
Editor: David Buffington

LGB is a registered trademark of Ernst Paul Lehmann Patentwerk, Nürnberg, Germany. Other trademarks are the property of their owners.

Products and specifications are subject to change without notice.

This book includes references to products and services that are not produced by the publisher or editor. These references are not an endorsement of those products and services.

The publisher and editor have used their best efforts in preparing this book. The publisher and editor make no representation or warranties with respect to the accuracy or completeness of the contents of this book and specifically disclaim any implied warranties of merchantability or fitness for any particular purpose and shall in no event be liable for any damages.

© 1998 Ernst Paul Lehmann Patentwerk. All rights reserved. No part of this book may be reproduced in any form or by any means without the prior written permission of the publisher.

Ernst Paul Lehmann Patentwerk
Saganer Strasse 1-5
D-90475 Nürnberg
GERMANY
Telephone: +911 83707 0
Fax: +911 83707 70
Internet: www.lgb.de

LGB of America
6444 Nancy Ridge Drive
San Diego, CA 92121
USA
Telephone: +619-535-9387
Fax: +619-535-1091
Internet: www.lgb.com

First printing, September 1998
Printed in Germany

Product Number 00559
Dieses Buch is auch in deutscher Sprache erhältlich (00550).



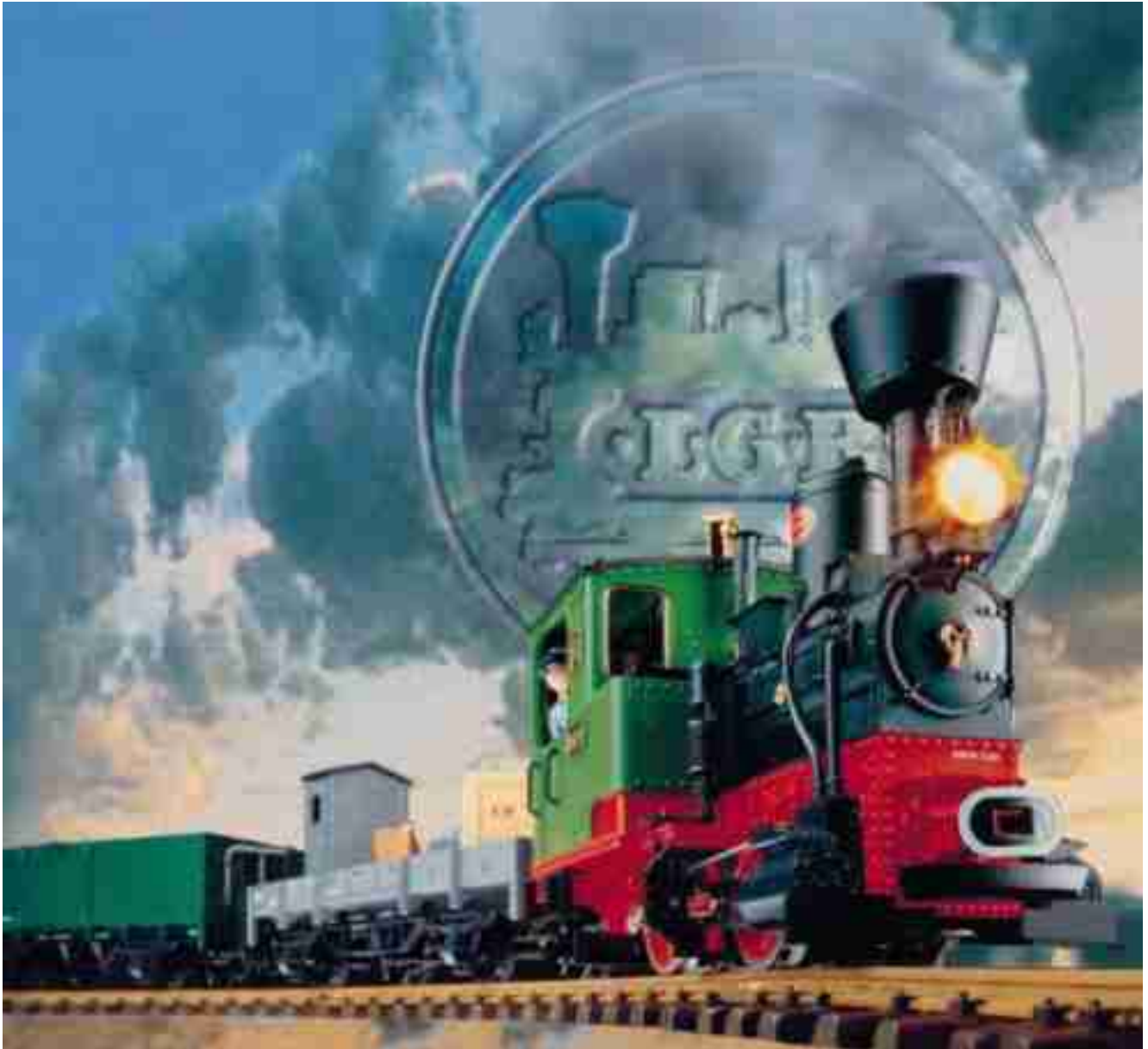

LGB's trademark Stainz locomotive leads the way.



Table of Contents

<i>Chapter</i>	<i>Page</i>
How to Use this Book	7
An Invitation to Exploration	9
1. A Tradition of Innovation	10
2. What is LGB?	15
3. Quick Start	20
<i>How to Assemble a Starter Set</i>	
4. The Next Step	25
<i>Expanding a Starter Set Layout</i>	
5. On Track	41
<i>Layout Design Basics</i>	
6. Working on the Railroad	60
<i>Track Laying Techniques</i>	
7. More Power	82
<i>LGB Power Supplies and Controls</i>	
8. More Trains, More Fun, Less Work	95
<i>The LGB Multi Train System</i>	
9. Taking Control	105
<i>The LGB "EPL" System</i>	
10. Form and Function	128
<i>LGB Signals</i>	
11. The Start of an Empire	137
<i>Medium Layout Plans</i>	
12. Leading the Way	160
<i>Innovative EPL Applications</i>	
13. A Better World	168
<i>Accessories for Your LGB Layout</i>	
14. Think Big	181
<i>Large Layout Plans</i>	
15. Staying on Schedule	201
<i>Maintenance and Service</i>	
Safety Tips for Smart Explorers	212
Thanks!	213
Product Index	215



LGB's 20680 rail truck is the centerpiece of this richly detailed diorama



LGB Q&A

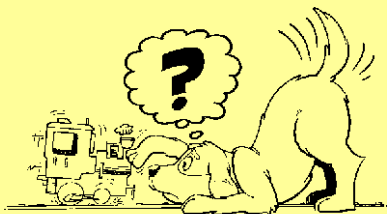

<i>Quick Answers to Your LGB Questions</i>	
<i>Question</i>	<i>Page</i>
What is the difference between LGB, Lehmann and Ernst Paul Lehmann Patentwerk?	14
What is G scale?	19
What should I use for smoke fluid?	23
How can I pull more cars?	37
How should I join the rails?	77
What is flex track?	78
How much power do I need?	92
Can I use a car battery to power my layout?	93
Can I use my old locos with the Multi-Train System?	102
How do EPL drives work?	113
What do I need to power electric signals and switches?	136
How can I add lights to my train?	180
What plants should I use in my garden railway?	197
What should I do if my train needs repairs?	210
Where can I learn more about LGB?	211

Discoveries

<i>True Stories from the World of LGB</i>	
<i>Story</i>	<i>Page</i>
Christmas Fun for Everyone	39
Beyond the Starter Set	57
Layout Building for the Intimidated	80
Torture on the Tracks	94
Operations on the C&W Railroad	157

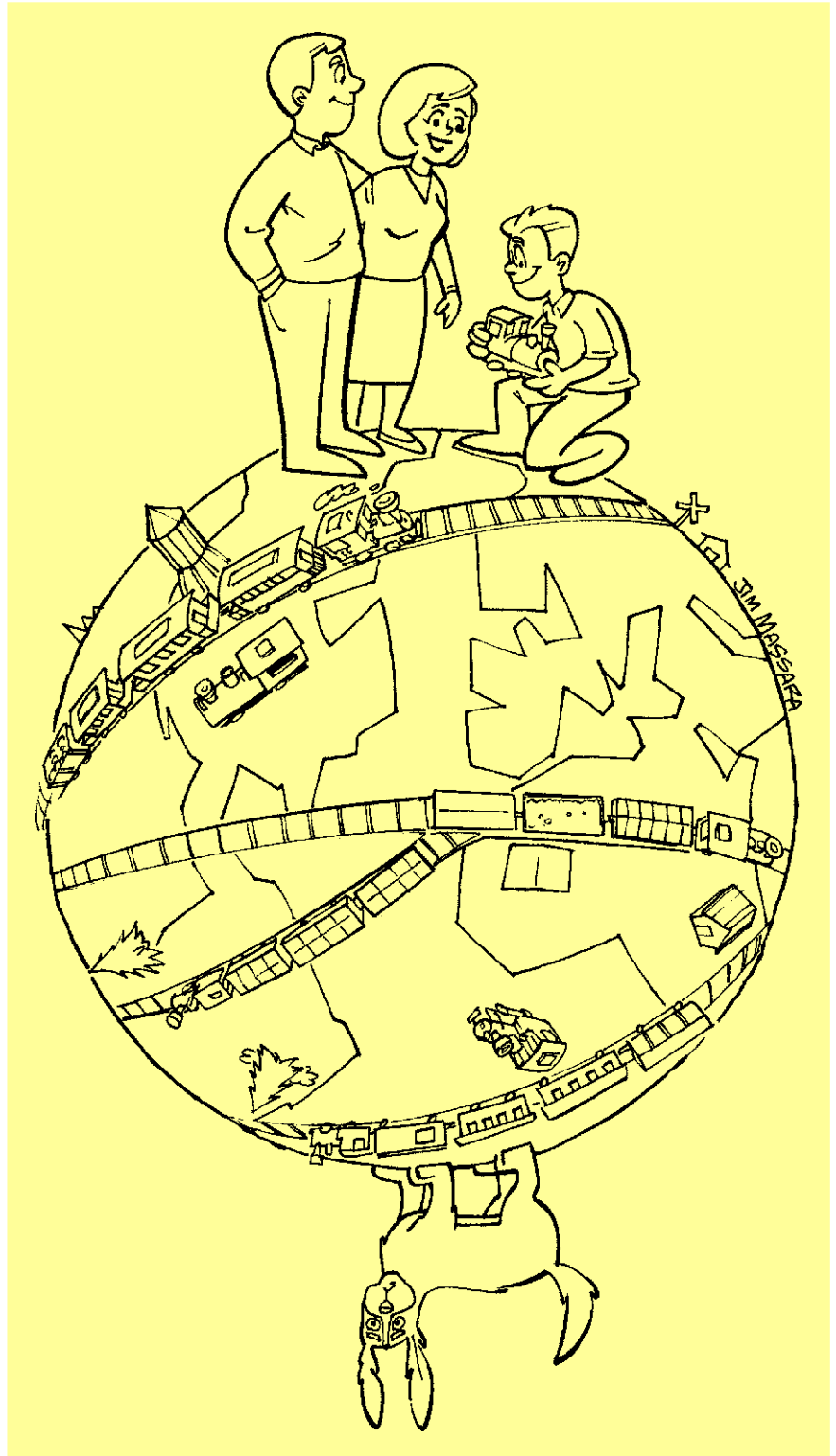

Follow the Lang family as they explore the World of LGB.



How to Use this Book

You could read this book from cover to cover, and in the process, you could learn a lot about the World of LGB. However, you could learn a lot more by combining reading with doing. As you read about track combinations, assemble the combinations yourself. As you read about wiring switches, wire some switches yourself.

By doing it yourself, you will see the concepts at work and understand the concepts more clearly. (In fact, after you've tried it yourself, you may want to re-read the text to discover more advanced concepts.) Through this process of reading and doing, your understanding of the World of LGB will quickly grow.

Here are a few more hints for using this book:

- Think of the circuits and layouts shown here as building blocks. By assembling different blocks, you can create different layouts to suit your different desires.
- Use the Index. You can use it to find specific information...or just to wander through the World of LGB.
- Follow the Lang family—Paul, Heidi, Alex and Rex—as they explore the World of LGB. In key chapters, you'll see how they started, expanded and enjoyed their own LGB layout.

• This book uses these abbreviations for measurements:

millimeters = mm

meters = m

kilometers = km

inches = in

feet = ft

miles = miles

square = sq (as in "sq ft")

amps = A

AWG = American Wire Gauge







volts = V

degrees = °

• Measurements are stated in metric units (like millimeters and meters). English measurements (like inches and feet) are approximate and provided for rough reference only. However, you should verify **all** measurements before installing, replacing or modifying anything. Remember the old saying, "Measure twice, cut once."

• The wiring diagrams in this book use LGB standard wire colors (see chart). For legibility, however, white wires are indicated with a gray line.

• Occasionally, you will see the German abbreviation "Trafo" in wiring diagrams. "Trafo" refers to LGB transformers or power packs.

blau/blue	
gelb/yellow	
grün/green	
orange/orange	
rot/red	
schwarz/black	
weiss/white	



*LGB starter sets are
the first step in your journey
through the World of LGB.*



An Invitation to Exploration

LGB trains are part of an unmatched program of more than 500 G-scale products, including locomotives, passenger coaches, freight cars, track sections and accessories. Every one is engineered for reliability, crafted with the finest materials and backed by our family commitment to give you years and years of dependable service.

But LGB trains are more than quality products. They are more than cold pieces of metal and plastic. LGB trains are your ticket to a fascinating world of unlimited possibilities!

With LGB, you can play indoors or outdoors. You can have fun with your family. You can entertain your friends. You can recreate great old places or create fantastic new lands. You can engineer a vast empire or just watch the trains go 'round and 'round.

This guide will help you use the LGB program to turn those possibilities into realities. It will answer your questions and feed your imagination. Most of all, this guide is an invitation from us and from all the employees of Ernst Paul Lehmann Patentwerk to explore our world: The World of LGB.

Happy LGBing!

Johannes
Rolf
Wolfgang

Johannes, Rolf and Wolfgang Richter
Ernst Paul Lehmann Patentwerk

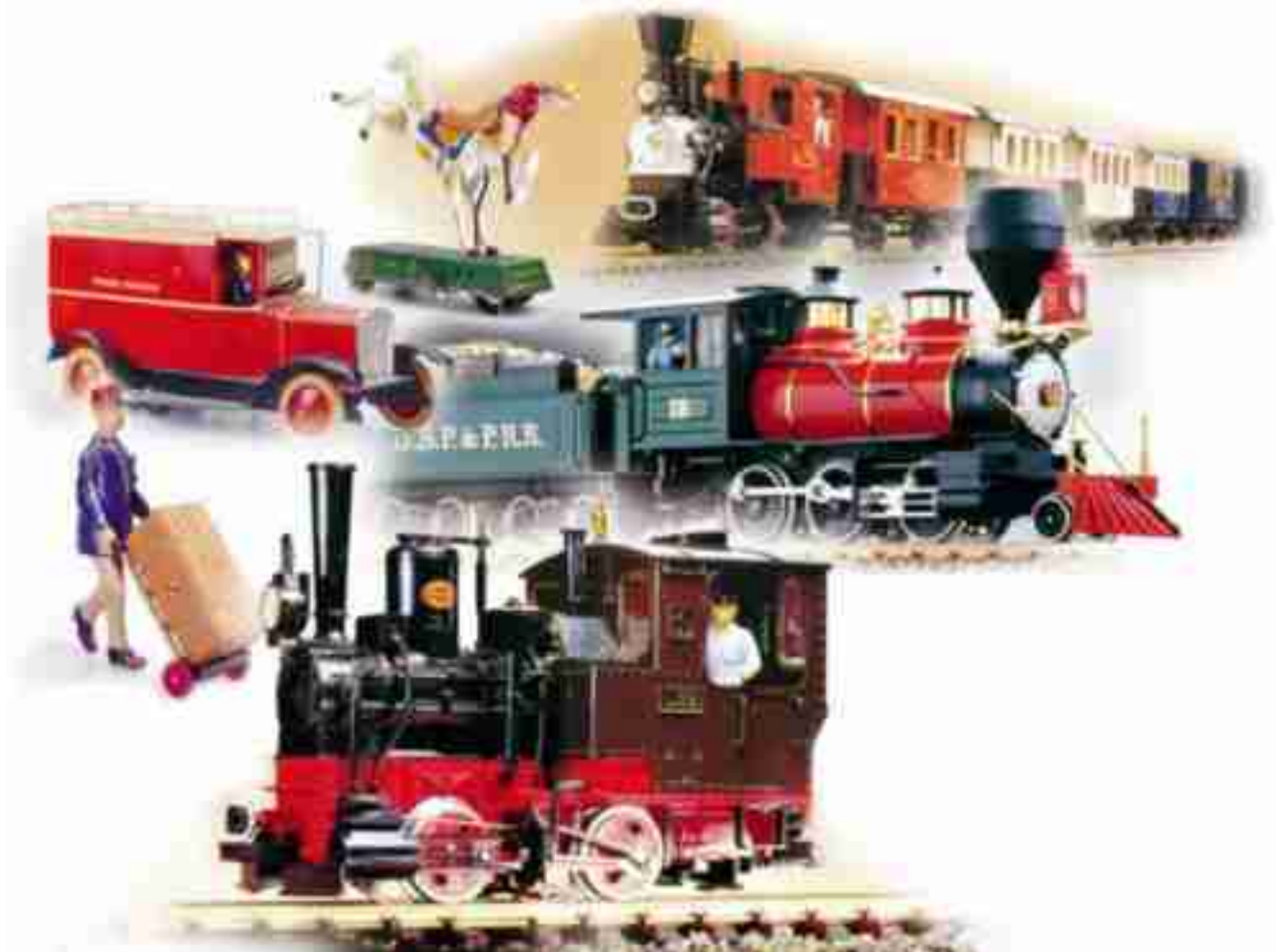

CHAPTER 1: A TRADITION OF INNOVATION

*Historic trains and toys from
Lehmann (clockwise from left):
Adam Porter (1914), DR Mail
Truck (1929), Wild West
Bronco (1909), LGB Jubilee
Train (1981), LGB Mogul
(1985), LGB Stainz (1968)*





Ernst Paul Lehmann, inventor

In February 1968, the first LGB train made its first public appearance in the snow outside the Nürnberg Toy Fair. However, the story of LGB—The Big Train actually begins much earlier.

In 1881, Ernst Paul Lehmann and Jean Eichner founded a small toy-making company in Brandenburg, southwest of Berlin. At first, the company struggled for survival. Eichner died in 1884, and the company's toys sold poorly. Records from this period are scarce, but piracy was a problem. Other makers would simply copy Lehmann's toys, hurting his sales.

Lehmann decided he must make toys that could be patented and legally protected from copying. As an inventor, Lehmann had experience with patents. Earlier, he won patents for manufacturing tin canisters, and the sale of those patents gave him the funds he used to start the toy company.

To get the company back on its feet, Lehmann used his earlier experience and began manufacturing tin cans. By 1888, however, Lehmann was back in the toy business, and he diligently sought patents for his toys. In a remarkable period between 1900 and 1910, Lehmann earned 50 patents, and his "patent" toys, like the propeller-driven Ikarus airplane, soon gave Lehmann a worldwide reputation for toy innovation.

The one thing Lehmann lacked, however, was a natural successor. He had no children, and so, he recruited his younger cousin, Johannes Richter, as an apprentice in 1908. Like his cousin, Richter had a talent for both business and invention, and in 1921, Lehmann made him his partner.

Richter quickly built on Lehmann's success with patented toys like the ingenious Skirolf skier and the original Rigi cableway. However, history would soon interrupt the company's progress. In the years before and during World War II, Richter could not find sufficient materials or manpower to maintain production. By the end of the war, the 20,000 square meter (215,000 square foot) factory employed just 45 people, and after the Soviet army occupied Brandenburg in May 1945, all production ended.



Lehmann's "Ikarus" monoplane, introduced in 1913, featured a patented propeller system.

Amidst the rubble of war, Richter found a way to restart production, producing a simple tin abacus for export to the Soviet Union.

Unfortunately, history would soon strike the family firm again. The communist government of East Germany began "expropriating" private firms, taking them without compensating the owners, and it happened to the Richters on April 25, 1948. The communists took everything: the factory, the machinery, the molds and even the family home. Richter moved his family to the west, first to West Berlin and then to Nürnberg in West Germany.

It was time to innovate again. In 1950, Richter resumed production with one stamping machine and three employees. His young sons, Eberhard and Wolfgang, joined him, and together, they began to rebuild the family firm. The elder Richter died in November 1956. He would not see the results of their efforts.

Post-war demand for consumer goods of all kinds fueled the company's recovery. At first, the company's toys were updated versions of old Lehmann toys. Later, the Richter brothers began to develop successful new toys, like the patented Nunu "gobbling" hedgehog and the Gnomy line of friction-powered trains and trucks. Soon, the company moved into a new factory located in the Nürnberg suburb of Altenfurt.

Still, there were dark skies on the horizon. Competition from Asian companies was threatening the European toy industry. Eberhard and Wolfgang decided that the company needed a new product, a unique product that could not be easily pirated. But what?

As children, Eberhard and Wolfgang loved model trains. They had even tried to play with their trains outdoors, but those trains were too small and too fragile. The tracks bent. The metal corroded. The motors stopped.

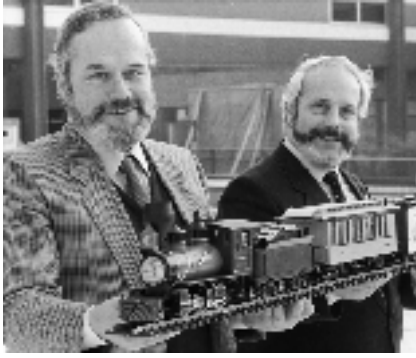

The Richter brothers, Wolfgang (left) and Eberhard (right), with the original LGB Mogul locomotive

They remembered that experience, and when they grew up, the Richter brothers decided to make a different kind of train. It would be big, four times the size of HO scale trains. It would be rugged and weather resistant. It would be made by skilled craftsmen with advanced materials. It would be the greatest innovation—and the boldest gamble—ever by the family firm.

In 1968, the Richters introduced their new train at the Nürnberg Toy Fair. It was the world's first model railroad for indoors and outdoors. They called it LGB—The Big Train.

At first, industry experts were skeptical. In an era of miniaturization, the idea of such a big train seemed silly. However, consumers loved LGB, and it was an immediate sales success. To accommodate demand, the factory was expanded in 1980 and again in 1984, and in 1988, the company opened a customer service center, LGB of America, in San Diego to serve the growing number of LGB enthusiasts in North America.

Today, a new generation, Johannes and Rolf Richter, is leading LGB into the new century. Of course, the company is still an innovator, with advanced products like the digital Multi-Train System. Also, the company is still growing, with another major expansion of the Nürnberg factory now being planned.

Despite this success, Ernst Paul Lehmann Patentwerk is still family owned and operated, a rarity in today's toy industry. For you, this family tradition of innovation means that there will always be new ideas, new products and new places to explore in the World of LGB.

A Chronology of Ernst Paul Lehmann Patentwerk

The Lehmann "Presse" Logo



- 1881 Ernst Paul Lehmann and Jean Eichner establish a toy company, "Lehmann & Eichner" in Brandenburg, Germany.
- 1884 Jean Eichner dies. Lehmann becomes the owner of the struggling firm.
- 1888 Lehmann begins production of "patent" toys that can be protected by patent and trademark laws. The Lehmann Presse logo, a simple drawing of a tin stamping press, is registered as the company trademark.
- 1894 Lehmann employs more than 100 people.
- 1895 The factory is destroyed by fire.
- 1898 Lehmann purchases another toy maker, Carl Adam, as part of the rebuilding process.
- 1904 Lehmann travels to the St. Louis Exposition, beginning a family tradition of close ties to America.
- 1908 Lehmann hires his younger cousin, Johannes Richter, as an apprentice.
- 1911 Richter leaves to form his own company. He invents the Aqua Spüler, a toilet flushing mechanism still used today.
- 1921 Lehmann signs a partnership agreement with Richter.
- 1926 The name "Ernst Paul Lehmann Patentwerk" is adopted.
- 1934 Ernst Paul Lehmann dies. Richter becomes the new owner.
- 1940s Metals and other toy materials are diverted to the armaments industry. Company employment falls to 45 people. Production ends when the Soviets occupy Brandenburg.
- 1946 The company produces a tin abacus, which is exported to the Soviet Union.
- 1948 The communist government seizes the family firm. Richter moves his family to West Berlin.
- 1950 Richter reopens the company in a small house in Nürnberg, West Germany. He is aided by his young sons, Eberhard and Wolfgang.





The Richter cousins, Rolf (left) and Johannes (right), continue the family tradition at Ernst Paul Lehmann Patentwerk.

- 1956 Johannes Richter dies. Eberhard and Wolfgang take over management of the company.
- 1959 The Richters open a new factory in the Nürnberg suburb of Altenfurt.
- 1968 The company introduces LGB—The Big Train at the Nürnberg Toy Fair.
- 1980 The factory is expanded to satisfy demand for LGB trains.
- 1981 Wolfgang Richter's son, Rolf, joins the company. He will become responsible for marketing and administration.
- 1984 The factory is expanded again, more than doubling its size. However, shortly after the expansion is finished, Eberhard Richter dies suddenly.
- 1988 Eberhard Richter's son, Johannes, joins the company. He will become responsible for production. The company establishes LGB of America, a customer service center in San Diego, California.
- 1994 More than 12,000 LGB fans attend an open air festival at the Nürnberg factory.
- 1998 More than 45,000 LGB fans from around the world come to Nürnberg to celebrate the 30th birthday of LGB trains.

Thirty Years of LGB Firsts



The craftsmen and craftswomen of Lehmann use advanced technology to create advanced LGB trains.

Ever since Ernst Paul Lehmann Patentwerk introduced LGB trains in 1968, the family firm has been the innovator in G-scale model railroading. Here are just some of the G-scale firsts for LGB trains:

Year	First	Model
1968	Indoor/outdoor trains, track	20301
1969	Switches	1200
1969	Loco with smoke generator	2010D
1969	G-scale magazine	0010
1970	Polycarbonate body parts	3011
1971	Signals	5029
1971	Overhead catenary system	6000
1973	Twin-motor loco	2095
1974	Steam sound loco	2080S
1978	Articulated loco	2040
1983	Two-wire switch control	1201
1984	American prototype loco	2018D
1986	Rack drive loco	2046
1992	Track cleaning loco	20670
1993	Automatic uncoupling loco	21900
1993	Automatic self-unloading car	41610
1994	10 Amp UL/GS power pack	50100
1994	Digital sound loco	20882
1995	Multi-Train System	55000
1996	Loco with four inline drive axles	28001
1997	Starter set with sound loco	70301

LGB Q&A

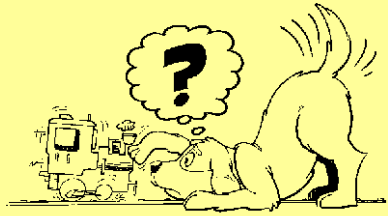

What is the difference between LGB and Lehmann?

Ernst Paul Lehmann Patentwerk is the name of the company that makes LGB brand G-scale trains. It was founded in 1881 by an inventor named Ernst Paul Lehmann. The word Patentwerk simply means that the company makes patented products.

Ernst Paul Lehmann Patentwerk also makes TOYTRAIN brand toy trains. TOYTRAIN trains are completely compatible with LGB trains, but they are designed especially for young railroaders.

Ernst Paul Lehmann Patentwerk makes LGB brand G-scale trains, like this big F7-A locomotive.



Ernst Paul Lehmann Patentwerk also makes TOYTRAIN brand toy trains (left) and Lehmann brand play toys (right).



Finally, Ernst Paul Lehmann Patentwerk makes Lehmann brand toys, like the Rigi cableway systems and Gnomy friction-powered vehicles.

Still confused? Don't worry. Ernst Paul Lehmann Patentwerk makes every product with a family commitment to quality and innovation. You can count on that, no matter what the name.



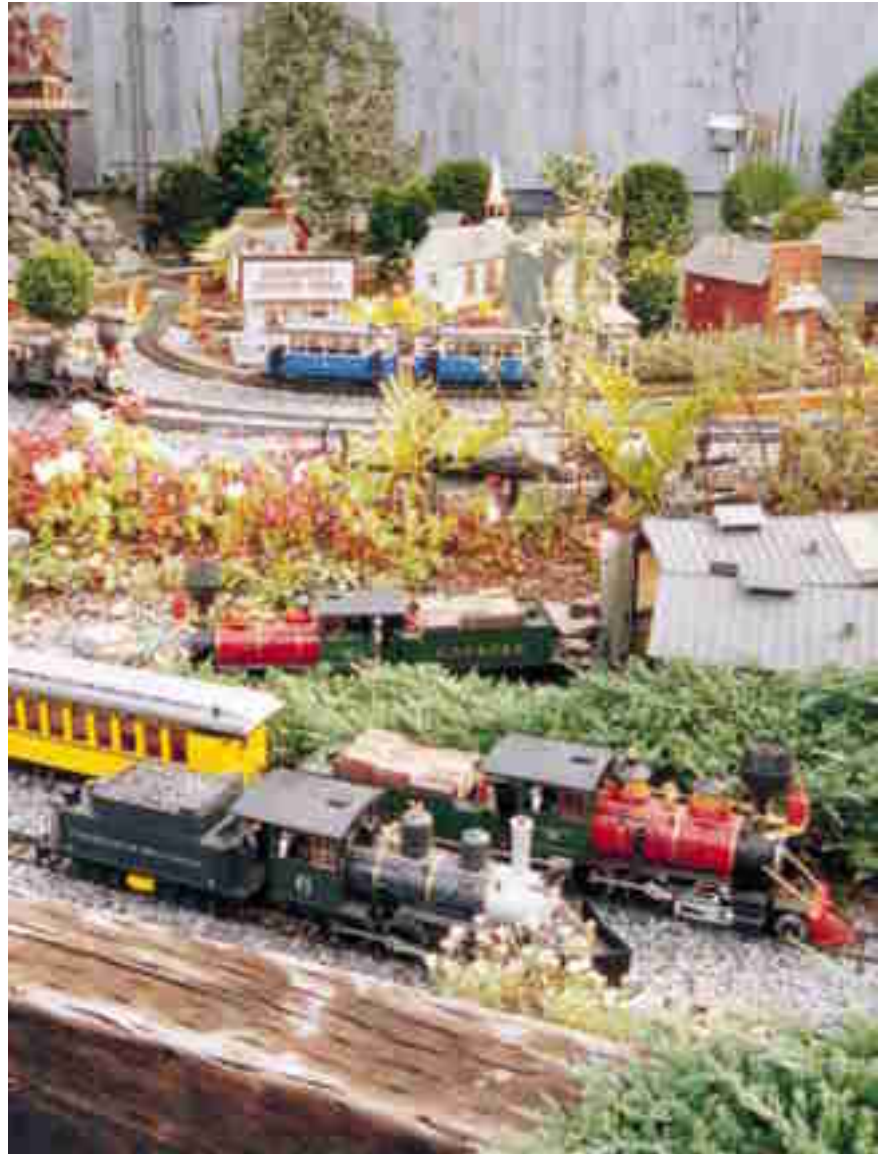

CHAPTER 2: WHAT IS LGB?

This garden railway, in the northeast United States, combines American and European prototype trains.

LGB is many things...

LGB is big. In fact, the letters "LGB" stand for "Lehmann Gross Bahn" or "Lehmann's Big Train." LGB trains are G scale (1:22.5). That's almost four times larger than conventional HO-scale trains (1:87) and almost ten times larger than Z-scale trains (1:220).

Because of their size, LGB trains are easy to put on the track, even for children. Details are big enough to see and strong enough to withstand frequent handling. Bodies are thick enough to survive accidents. Cars are easy to couple and uncouple.

Trains stay on track, even on uneven surfaces.

LGB is for indoors and outdoors. LGB is the first production model railroad designed for both indoor and outdoor use. Major body parts are made of engineering plastics, like BASF Luran-S, an impact-resistant polycarbonate. Ultraviolet-resistant plastics and coatings are used to protect LGB trains from harsh sunlight, even in tropical climates. Gearboxes are protected from dirt and moisture. Control boxes can be permanently mounted outdoors without any special protection.

Don't forget about indoor operation. LGB trains are both realistic and beautiful. They look good on traditional model railroad layouts and in unconventional displays, like shelf and ceiling layouts. Indoor LGB layouts can be found in basements, kitchens and formal living rooms. You can also find LGB layouts in commercial establishments, from McDonald's restaurants to five-star hotels.

LGB is simple. LGB trains are designed for people who want to have fun with trains. You don't need to be an expert mechanic or electronics wizard to enjoy LGB. Track sections connect quickly without tools. Electrical connections are simple with color-coded wires and terminals. With LGB, you can start having fun right away.

And once you start, you can keep going and going and going. Trains stay on track with oversized wheel flanges and rugged "hook-and-loop" couplers. Locomotives run for years with seven-pole Bühler motors and multiple electrical pickups. LGB's exclusive "EPL" train

This is the actual size of an LGB "Stainz" locomotive.

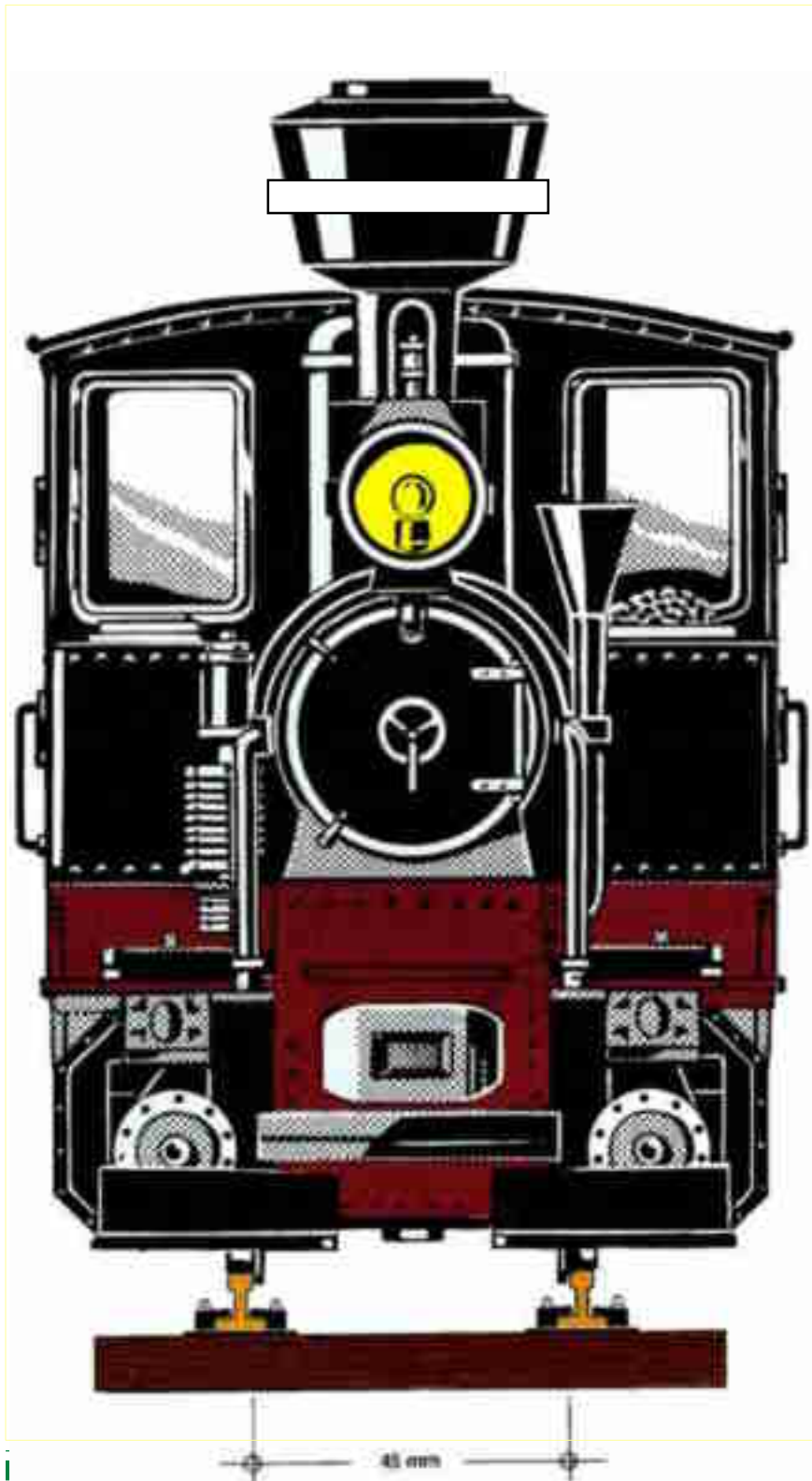

LGB indoor layouts are lots of fun and easy to install.



controls let you build a fully automated layout. Just start it up and watch it run!

LGB is complete. The LGB program includes more than 500 quality G-scale products. There are American trains and European trains. There are steam locomotives, diesel locomotives, electric locomotives. There are hand cars, rail trucks and even propeller-driven rail vehicles. There are over 30 different track sections, including crossings, turnouts and flex track. There are power supplies for small layouts and large layouts and multi-train layouts. There are signals, overhead catenary systems, bridges and figures.

And all LGB products are engineered to work together. Even the biggest LGB freight car will run on the smallest radius LGB track. Even the oldest LGB loco can be used with the newest LGB digital controls. Every LGB

LGB trains are ruggedly engineered for indoor and outdoor use.



*See all the trains from
around the World of LGB
in the big LGB catalog,
available at your favorite
LGB retailer.*



LGB Q&A

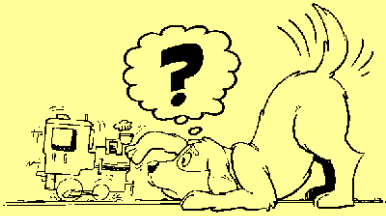

What is G scale?

LGB trains are "G-scale" trains. When Eberhard and Wolfgang Richter introduced LGB in 1968, they defined G scale as a model-to-prototype ratio of 1:22.5.

In other words, a G-scale model train is 22.5 times smaller than the real train it represents. By comparison, an HO-scale model train is 87 times smaller than the real train it represents, and a Z-scale train is 220 times smaller than the real train.

Although 1:22.5 sounds like an odd figure, it really makes sense. 1:22.5 is the proportion required to model real "prototype" meter gauge trains using 45 mm "Gauge 1" model track. The math is simple:

**Distance between the rails
of real-life meter gauge track 1,000 mm**

Divided by the G-scale proportion $\div 22.5 \approx$

Equals the distance between the model rails ... 45 mm



Switzerland's modern Rhätische Bahn (above) and America's tiny Grizzly Flats (below) are just two of the fascinating narrow-gauge railways around the world.

Why is it called "G" scale? The Richters chose the letter "G" because it describes LGB in many different languages. In German, G means "gross" or "garten." In English, G stands for "garden." In French, G is "grande." And around the world, G is "growing."

Indeed, modeling meter gauge has many advantages for LGB fans. About one-third of the world's railways are meter gauge or other narrow gauges, and those unique lines offer some of the world's best modeling opportunities.

For example, Switzerland's famous Glacier Express features spectacular scenery and modern equipment. Germany's classic Harzquerbahn offers breathtaking steam operations. In North America, narrow gauge is enjoying a renaissance, and narrow gauge lines can be found across the continent from Alaska (White Pass & Yukon) to Colorado (Durango & Silverton) and Pennsylvania (East Broad Top). Additional narrow gauge railways are active in South America, Africa, Asia and Australia.

These lines are modelers' delights with scenic views, unique settings and interesting equipment rarely found on standard gauge railroads.





CHAPTER 3: QUICK START

LGB starter sets include everything you need to get started.



Are you ready to start exploring the World of LGB? In this chapter, we'll help you set up your first LGB starter set.

It's easy to get started with an LGB starter set! Every LGB starter set includes everything you need:

- a weather-resistant locomotive
- weather-resistant freight or passenger cars
- a full circle (or oval) of weather-resistant track with solid brass rails
- track clips
- a safety-approved power pack
- a quick-connect wiring cable
- figures
- instructions

You don't need any software. You don't need any glue. You don't even need any tools. Everything you need is in the package. (Even the package is special. It's decorated for gift giving and made from sturdy, environmentally-approved materials to protect your investment in LGB.)

There are many different LGB starter sets. There are passenger sets and freight sets. There are European train sets and American train sets. There are work train sets, circus train sets and even Christmas train sets. However, it doesn't matter which set you buy. Every LGB starter set has everything you need to start exploring the World of LGB.

Once you have your LGB starter set, just follow these simple steps:

1. Connect the tracks. The tracks make a full circle (1290 mm/51 in outside diameter). You can set up your layout almost anywhere, indoors or outdoors. LGB track is engineered for easy and frequent assembly and disassembly. So don't be afraid to experiment with different locations.

Hint: Do not set up your train on white or very light-colored carpet. Over time, the trains will leave a very small amount of carbon dust around the track.

Just slide the track sections together. You don't need glue or tools.

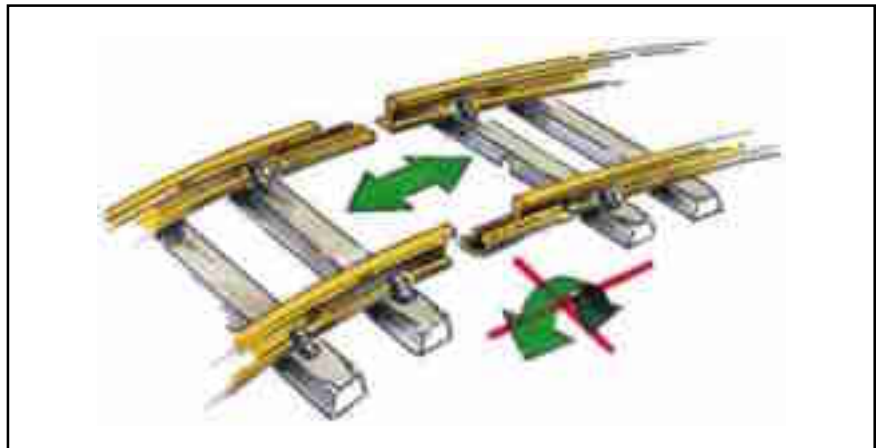

2. Attach the track clips. This is an optional step. The clips will prevent the track sections from pulling apart, especially on slippery surfaces like hard floors.

Make sure the number on the clip faces down.

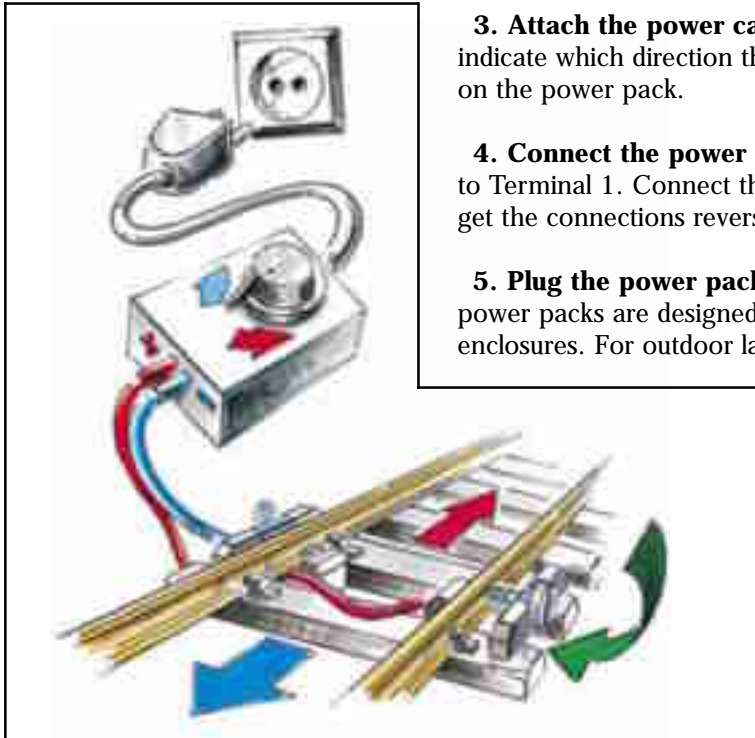

3. Attach the power cable to the track. The arrows in the drawing indicate which direction the train will go when you turn the control knob on the power pack.

4. Connect the power cable to the power pack. Connect the red wire to Terminal 1. Connect the blue wire to Terminal 2. (Don't worry if you get the connections reversed, the train will still run.)

5. Plug the power pack into a house current outlet. LGB starter set power packs are designed for use indoors and in weather-protected enclosures. For outdoor layouts, keep the power pack indoors and connect it to your track layout outdoors.

6. Put the train on the track. Push the "hook" on one car under the "loop" on the next car.

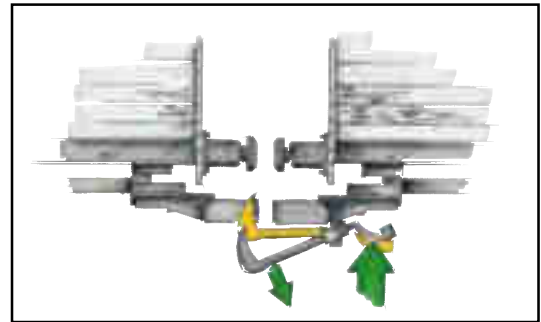

7. Turn on the locomotive sound (if equipped). The control switch in the loco cab is factory preset to the "on" position.

8. Put a few drops of smoke fluid in the smoke generator (if equipped). On most newer starter set steam locos, there is a switch inside the cab. See the loco instructions for the correct setting.

On some older starter set steam locos, there is a small silver switch on the bottom of the loco, directly under the smoke stack. Turn the switch until it touches the brass contact on the bottom of the loco, directly under the smoke stack.

Have fun! Turn the control knob on the power pack to make the train go forward and backward.



LGB Q&A

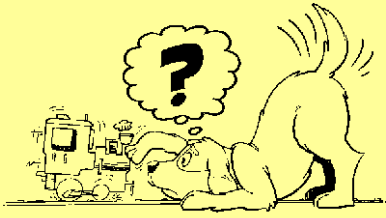

What should I use for smoke fluid?

Only use LGB Smoke and Cleaning Fluid (50010) in LGB locomotives with smoke generators. It's safe for LGB locomotives, and it's safe for you and your family.

Do not use other brands of smoke fluid, and do not use flammable liquids like lighter fluid or lamp oil. They may damage your loco...and more.

Hint: As the name suggests, LGB Smoke and Cleaning Fluid can be used to clean your LGB trains. Dip a soft brush in a dish of the fluid, and then brush your trains clean. The fluid will not hurt the plastic, and it will evaporate in a few minutes. Also, you can put a little fluid on a soft cloth to clean track rails.



LGB Smoke and Cleaning Fluid (50010) is safe for all LGB locos.



Lang Garden Bahn: Welcome to the family!

The Langs—Paul, Heidi, Alex and Rex—just bought an LGB starter set at their friendly local LGB retailer. Why LGB? Paul wanted LGB trains because they are big and strong, like the trains he remembered when he was young. Heidi knew that LGB would run great and look great in the garden. Alex got excited when he saw the LGB action cars. And Rex? Well, Rex just likes to chase trains.

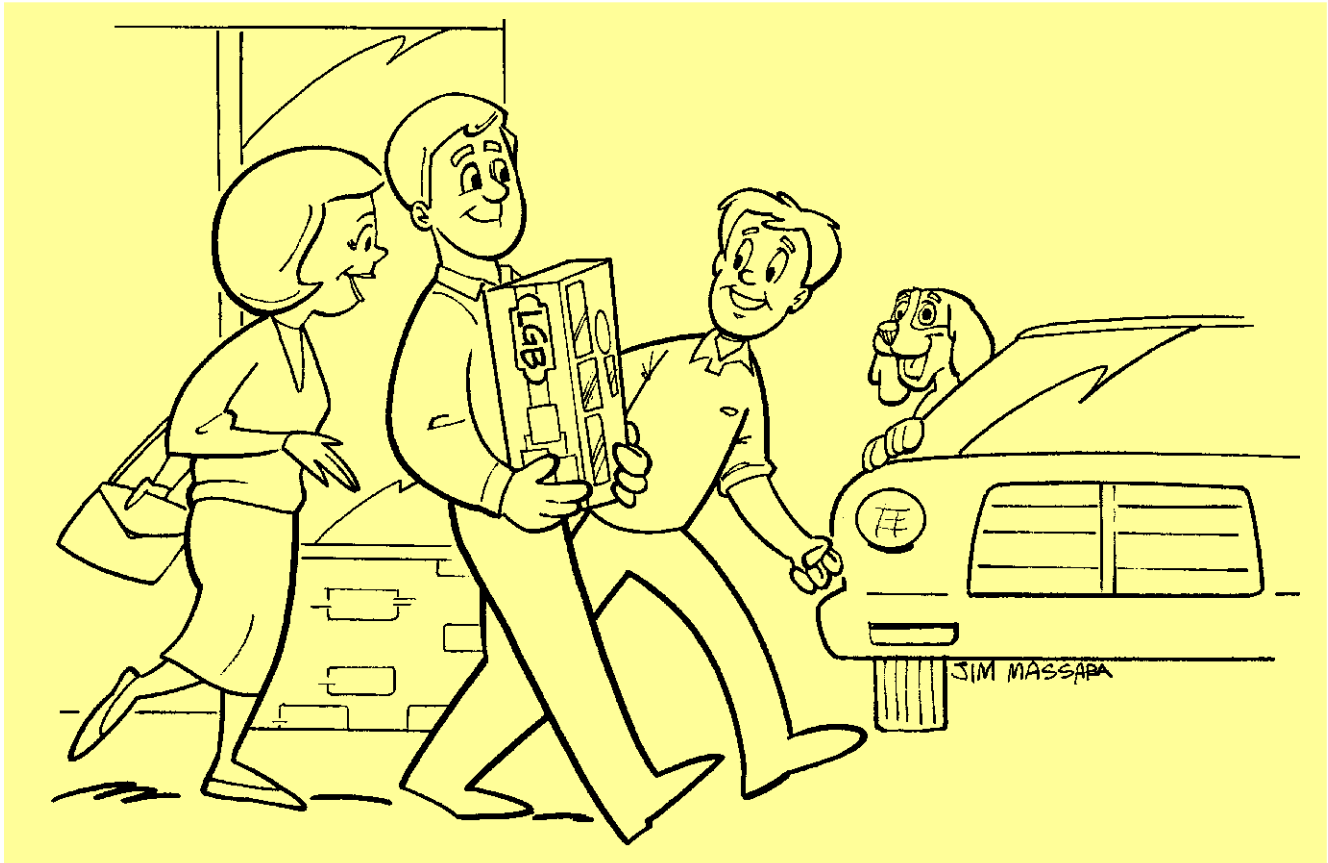

You can follow the Langs through these pages as they explore the World of LGB, and you can buy LGB trains at more than 9,000 LGB retailers around the world. To find an LGB retailer near you, contact:

Ernst Paul Lehmann Patentwerk
Saganer Strasse 1-5
D-90475 Nürnberg
GERMANY
Telephone: +911 83707 0
Fax: +911 83707 70
Internet: www.lgb.de

LGB of America
6444 Nancy Ridge Drive
San Diego, CA 92121
USA
Telephone: +619-535-9387
Fax: +619-535-1091
Internet: www.lgb.com





CHAPTER 4: THE NEXT STEP

*With LGB, it's easy to expand
beyond the starter set.*



The 19901 Siding Set (above)
and 19902 Station Set (below)



You bought an LGB starter set and entered the World of LGB. Now, where do you turn? Which direction should you go? There are so many possible paths. Should you add a locomotive. Or some cars? Or some buildings?

In this chapter, we'll help you take the next step beyond the starter set. Of course, with LGB, you can follow any path you like, but first, we recommend adding some track. Most LGB starter sets include a circle of track, and your engineer is probably getting tired going 'round and 'round. Also, a model train needs some place to "go," just like a real train.

With more track, you can create destinations, like a station, a passing siding or an industrial spur. With more track, you can create stories, like tales of adventurous passengers on a mysterious journey. With more track, you can create illusions, like the train that disappears behind a sofa and suddenly reappears at a station on the other side. With more track, you can really explore the World of LGB.

LGB Track Expansion Sets

An easy and economical way to add more track to your starter set circle is to use an LGB track expansion set. There are two different sets:

19901 Siding Set

With this set, you can enlarge your basic starter set circle into an oval with a "stub" siding (Layout 1). (A stub siding is a relatively short dead-end track used for parking trains at stations and factories.) The set includes:

- 6 - 10000 Straight Track, 300 mm
- 1 - 11000 Curved Track, R1, 30°
- 1 - 12000 Manual Switch, Right, R1
- 1 - Track Bumper

On a real railroad, sidings are used for loading, unloading and storing freight and passenger cars. You can use your siding for the same purposes. You can load LGB figures in passenger cars on the siding while waiting for the train to arrive. You can unload goods, like candies or pebbles, from freight cars. (Remember, LGB freight cars are made to handle real loads. For example, most LGB tank cars have opening hatches and drain valves so you can actually fill them with water.)

When you're finished with your trains, you can store them on a siding, for example, behind a sofa or under a bed. When you're ready to play again, just run the train out of the siding and onto the "main line."

19902 Station Set

With this set, you can enlarge your basic starter set circle into an oval with a "passing" siding (Layout 2). The set includes:

- 9 - 10000 Straight Track, 300 mm
- 2 - 11000 Curved Track, R1, 30°
- 1 - 12000 Manual Switch, Right, R1
- 1 - 12100 Manual Switch, Left, R1

Passing sidings can be used just like stub sidings. A train can enter or leave a passing siding without backing up. That's important when you're moving a lot of traffic through a busy passenger station or a freight yard.

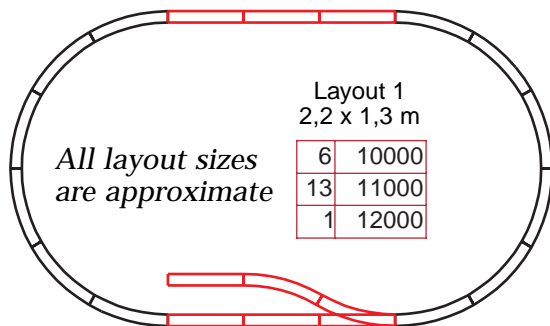

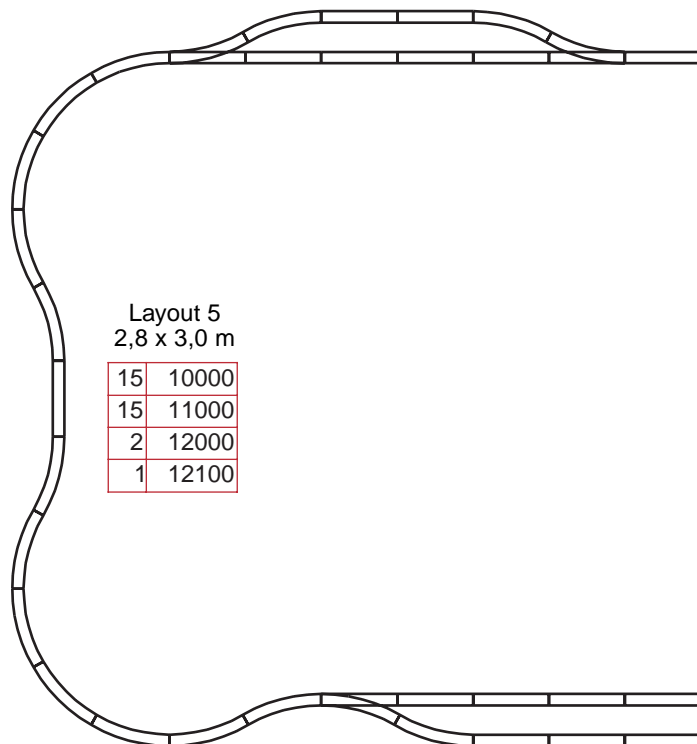
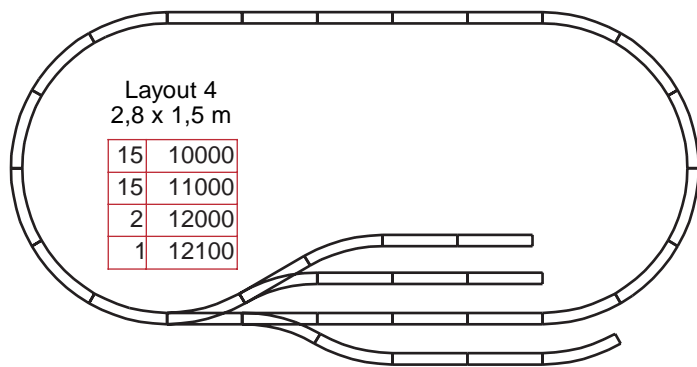
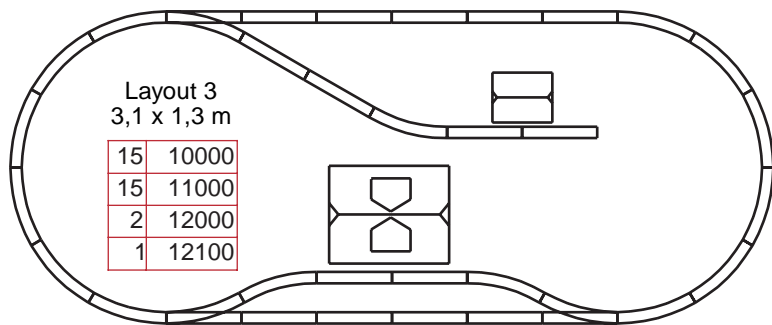
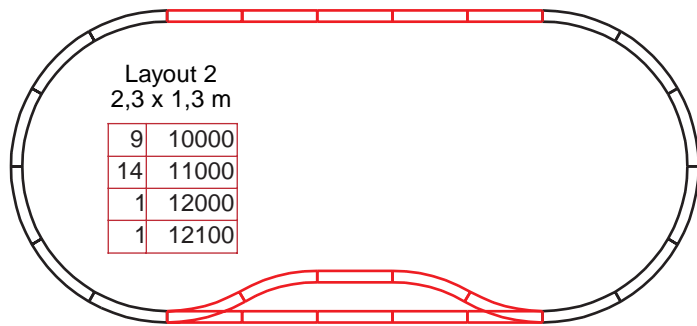

Of course, the beauty of building a model railroad is that you can make it any way you want. The track plans you see here are only suggestions. You can make your own plans to fit your needs (like the shape and size of the available space) and your desires (for authenticity or appearance or amusement).

For example, you can combine the 19901 Siding Set with the 19902 Station Set to make a very functional layout, like Layout 3. It is a compact oval shape with one passing siding and one long stub siding. Typically, a passenger station would be located alongside the passing siding. You could park a passenger train on the siding while another circles the oval. Freight cars would be maneuvered ("switched" or "shunted") to the stub siding for unloading at the freight platform.

If you are interested in freight yard operations, Layout 4 will give you plenty of opportunities. You can assemble complete trains by moving individual cars from the sidings to the main line. To make your job easier, you can insert a track-mounted uncoupler, like the 10520 Manual Uncoupler, on the main line.

Remember, you don't have to make an oval. Layout 5 is a wall-hugging "point-to-point" layout that would be perfect for a small bedroom. The passing siding at one end of the layout allows the loco to be transferred from one end of the train to the other. The stub siding at the other end of the layout might feature a coaling station with a second locomotive. The bend in the center would fit nicely around a window or heating unit.

This layout looks much bigger than an oval layout, but it is simply a starter set circle combined with one 19901 Siding Set and one 19902 Station Set. In fact, **Layouts 3, 4, 5, 6, 7 and 8 all use that same combination: a starter set circle, one 19901 Siding Set and one 19902 Station Set.**

Together, that combination—starter set circle, 19901 and 19902— includes this collection of individual LGB track sections:

Quantity	Number	Description
15	10000	Straight Track, 300 mm
15	11000	Curved Track, R1, 30°
2	12000	Manual Switch, Right, R1
1	12100	Manual Switch, Left, R1

Visualize Your Layout

Traditional track plans, whether they're created with pencils or computers, are cold and flat. They're necessary to illustrate the basic construction of a layout, but they're incapable of showing what that layout might look like in real life.

To help you visualize your layout, we've asked noted railroad artist J. Craig Thorpe to illustrate several of the track plans in this book.

For example, we gave Craig a copy of the Layout 6 track plan

(top right, next page). This kidney-shaped layout offers a curving route and opportunities for "operations," like shunting cars (at the station) and parking locomotives (at the water tower). Like many of the layouts in this chapter, Layout 6 is a combination of a starter set circle, a 19901 Siding Set and a 19902 Station Set.

Now visualize the layout as Craig did. In his illustration, a Mogul locomotive is assembling a passenger train at the station. A freight

Use your imagination to visualize what your layout will look like in real life.

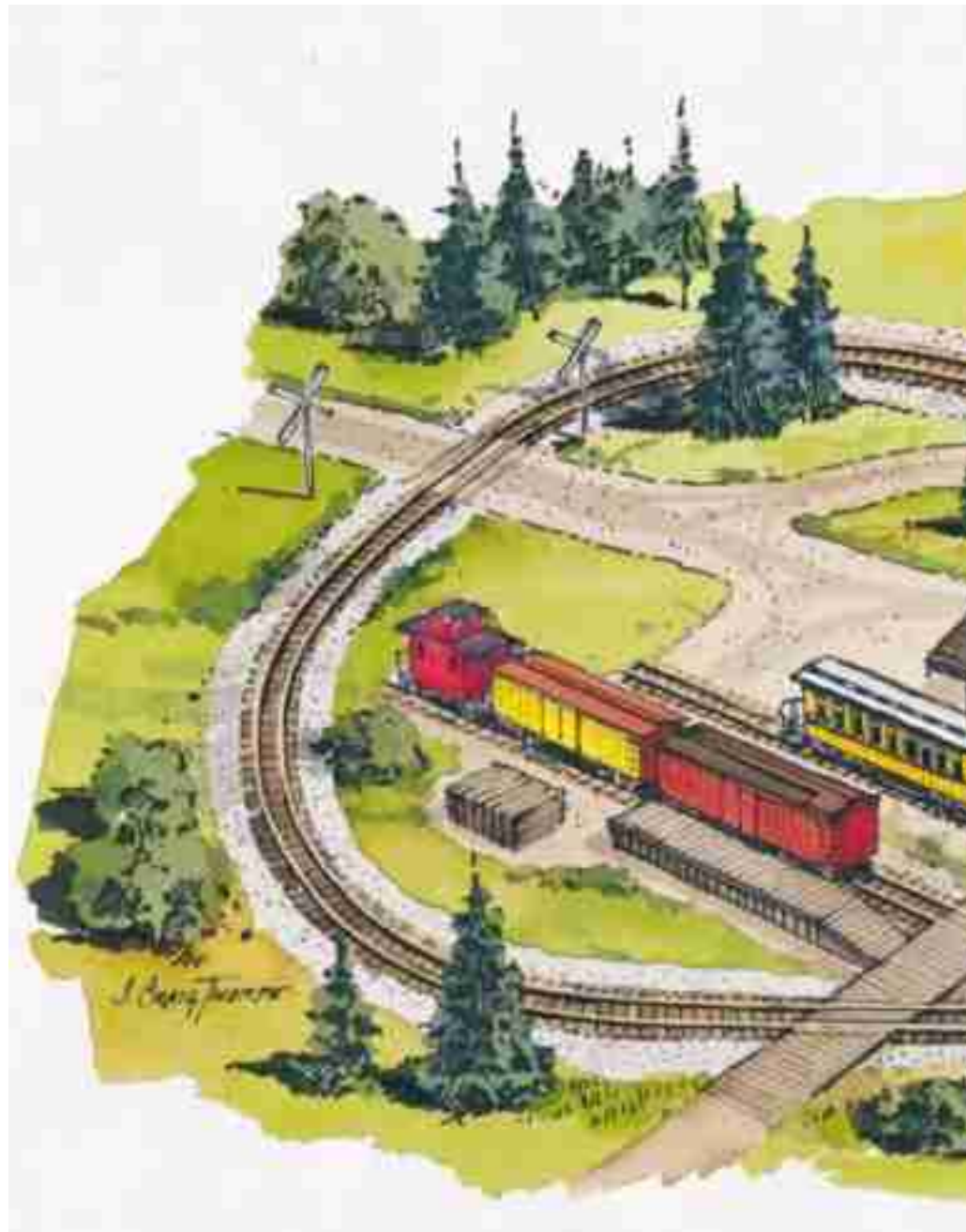

train waits on the second siding for a loco. The second loco is on the third siding taking on a tankful of water. Trees line the layout. Roads cross the tracks. Platforms stand ready for passengers and freight.

Of course, you don't have to use the same trains, the same structures or any of the same features. Just use your imagination, and visualize something fun.

Layout 6
2,7 x 1,6 m

15	10000
15	11000
2	12000
1	12100

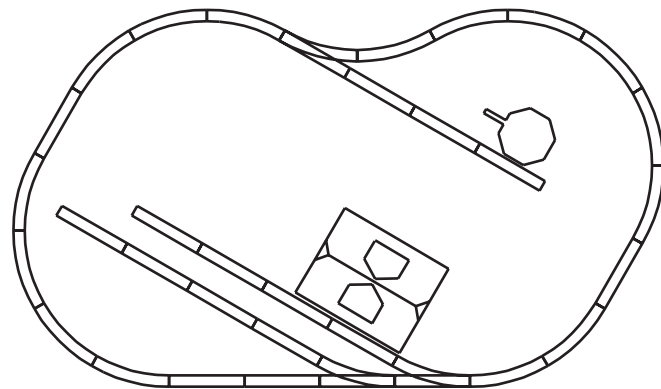

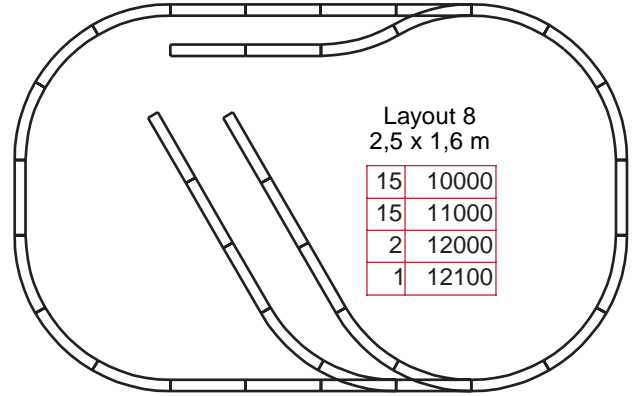
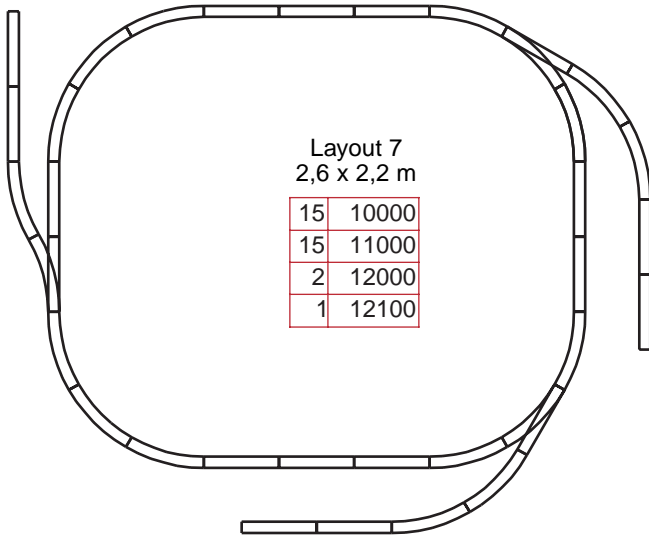

On a real railroad, trains pick up and deliver freight cars to industries along the line. Layout 7 lets you move freight among three industries. At the saw mill, the train picks up log cars. At the refinery, the train delivers tank cars. At the farm, the train picks up stock cars. Notice that all of the sidings on this layout work in the same direction. Because it is arranged this way, a train traveling counter-clockwise on the oval can easily back cars into each siding.

Layout 8 also offers three sidings, but all the sidings are inside the oval. This makes the layout very compact and perfect for small areas indoors. The entire layout is only 2490 mm long and 1590 mm wide (98 in long and 63 in wide), with a total area of less than four square meters (42 square feet). Despite the small size of the layout, the sidings are straight. It is much easier to couple and uncouple cars on straight track sections.

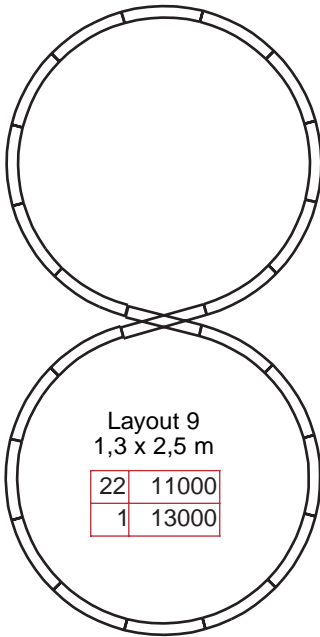

More Ways to Grow

The LGB track expansion sets are a great way to grow your starter set circle, but they're not the only way. The LGB program includes more than 30 different track sections, and they can be combined in an infinite number of ways. To start your exploration of the LGB track program, use some of the basic track sections from the earlier layouts:

10000 Straight Track, 300 mm

11000 Curved Track, R1, 30°

12000 Manual Switch, Right, R1

12100 Manual Switch, Left, R1

And add a few new sections, like the:

10150 Straight Track, 150 mm

13000 Crossing, 30°

15000 Curved Track, R2, 30°

The classic "figure-eight" layout (Layout 9) is loved by children of all ages. Why? It is very simple to build, requiring just two different track sections: 11000 and 13000. Also, it offers continuous visual movement; that is, your perspective on the train is constantly changing.

Will the crossing cause electrical problems, like short circuits? No, the two straight sections within the crossing are electrically isolated from each other. The frogs—the points where the rails intersect—are made of plastic to prevent short circuits caused by metal wheels.

Hint: Look closely at the Layout 9 track diagram, just left of the crossing. You can see that the track sections do not meet exactly. That's OK. The computer program used to draw these diagrams can only work with inflexible numbers. However, with LGB track, there is

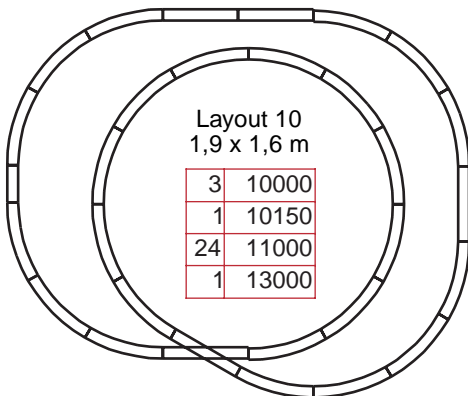

flexibility between track sections. You can adjust them to make up for small discrepancies in track geometry.

At first, Layout 10 doesn't look like a figure-eight, but look again. It is! One of the loops has been expanded and folded over the other loop. This

"folded figure-eight" requires much less space than a traditional figure-eight, but it has more track: about 9 meters total. It can be built using the same sections as the figure-eight plus two 11000 sections, three 10000 sections and one 10150 section. (The 10150 is 150 mm long, exactly half the length of a 10000 section.)

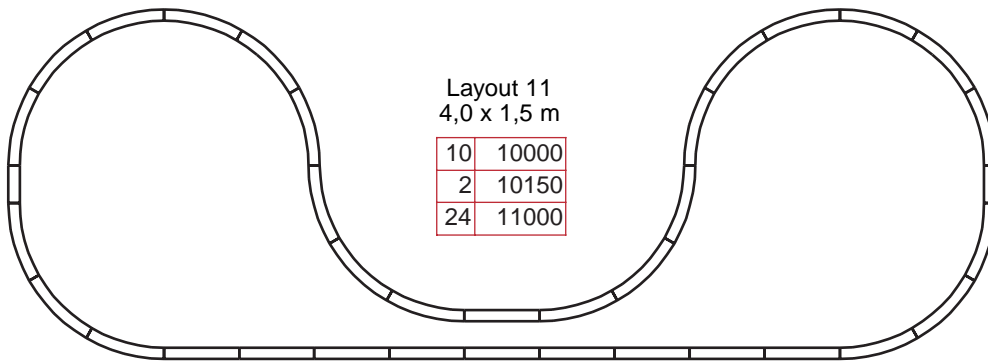

Layout 11
4,0 x 1,5 m

10	10000
2	10150
24	11000

Like the folded figure-eight, many layouts can be easily adjusted to suit your needs. For example, Layout 11 is a basic "dog bone" layout. It has a lot of track, so you can run big trains. The problem is that it is long, about 4.0 meters (13 feet) long.

Layout 12 is like Layout 11, but it's been folded. Now, it is only 2.6 meters (8.7 feet) long. If you want to add operating capabilities, you can do that also. In Layout 13, six sidings have been added. But since all of the sidings are inside the layout, the area occupied by the layout is the same.

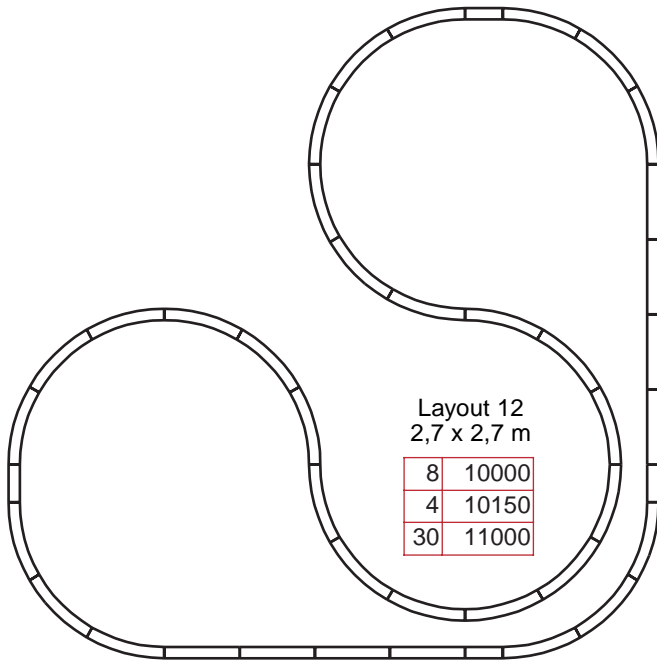

Layout 12
2,7 x 2,7 m

8	10000
4	10150
30	11000

Also, with just two switches and a few track sections (Layout 14), you can add an outer line to the folded dogbone. This increases the total length of track to a very impressive 25 meters (82 feet). Plus, this creates two different routes for your trains. If you electrically isolate the inner line (see Chapter 10), you can even perform switching operations on the inner line while operating a separate train on the outer "main line."

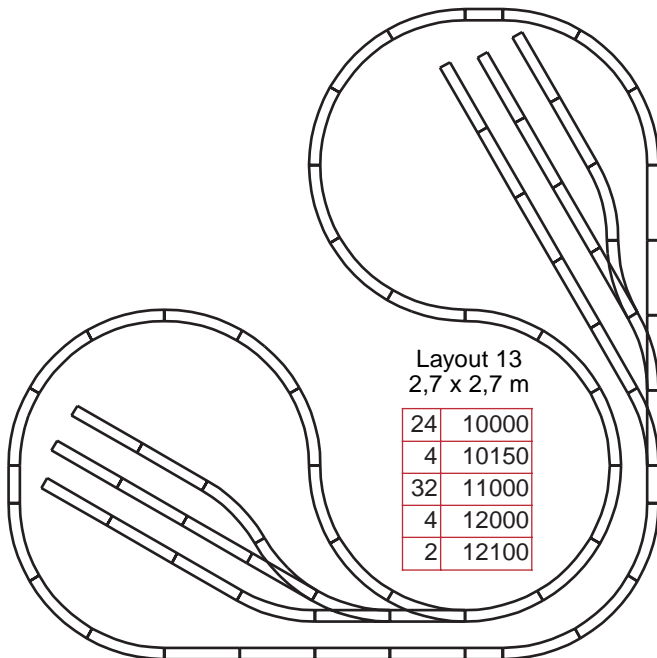

Layout 13
2,7 x 2,7 m

24	10000
4	10150
32	11000
4	12000
2	12100

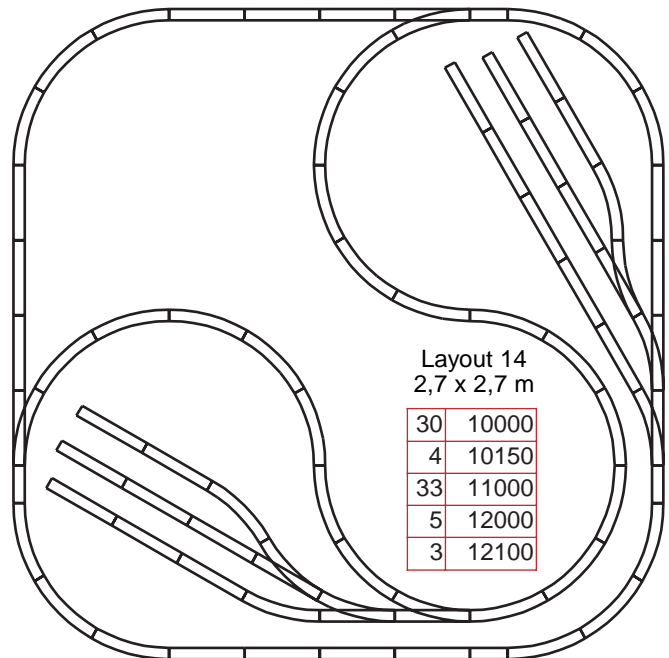

Layout 14
2,7 x 2,7 m

30	10000
4	10150
33	11000
5	12000
3	12100

Easy Two-Train Operation

You can operate two trains at the same time on all of the layouts you've seen so far. However, it requires some thought because the two trains share parts of the layout, and if you don't pay attention, the trains will, eventually, collide. (With LGB, that's not a tragedy. LGB trains have survived fires, floods and earthquakes. A simple collision is not likely to do tremendous damage.)

For unattended, two-train operation, you need a separate track for each train. With the LGB track program, you can do that easily. The key is the 15000 Curved Track, R2, 30°. This section is made to be used with the basic curved track section you have been using on all the earlier layouts: the 11000 Curved Track, R1, 30°.

The difference between the two sections is the radius. The 11000 is an "R1" radius track. The 15000 is an "R2" radius track. R1 represents a radius of 600 mm (23.6 in). R2 represents a radius of 778 mm (30.6 in). You can see the difference in the two track circles below (Layout 15).

In fact, you could build that layout and operate two trains on it. Just add two power supplies—one for each layout—and you're ready to go.

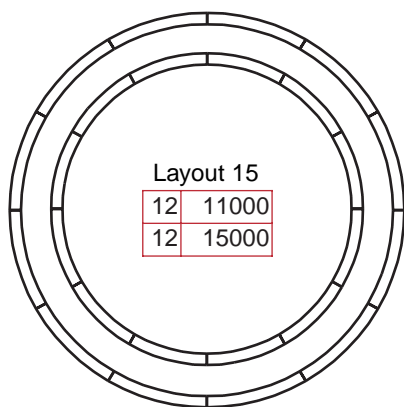

Of course, it would also be boring just to watch two trains circle each other. Layout 16 (above) is a bigger layout with interconnected tracks. Now you can see how the R1 and R2 curved track sections work together. The R2 radius was chosen so R1 and R2 sections could be conveniently interconnected using R1 radius switches, like the four in this layout.



Layout 16
2,9 x 1,7 m
(above)

12	10000
12	11000
2	12000
2	12100
12	15000

Unless you turn the wrong switch at the wrong time, the trains will never collide, but you can still move trains from one oval to the other.

You could use one power supply to control the entire layout, but then, both trains would operate at roughly the same speed all the time. That's not very realistic.

To solve the problem, LGB offers two options. The traditional option is to create electrically isolated track "blocks." Just install 10260 Insulated Rail Joiners between the inner and outer switches. That would electrically isolate the inner block from the outer block. Just add another power supply—one for each oval—and you're ready to go. (See Chapter 8 for more information.)

The modern option is to use the LGB Multi-Train System. This easy-to-use system lets up to eight people operate up to eight trains on the same track at the same time...without electrically isolated track blocks. (See Chapter 9 for more information.)

Under Control

To help you control your growing railroad empire, the wizards at Lehmann created the "EPL" system. The EPL system is an integrated program of switch drives, contacts, controls and other electric devices you can use for remote and automatic control of your layout.

The EPL system is explained in detail in Chapter 9, but to get you started, here are two of the most basic—and essential—EPL functions.

Switch Control: As your layout grows, some switches may be inconvenient to operate manually. That's why the LGB program includes a variety of electric switches that can be controlled remotely. Each LGB electric switch includes a 12010 "EPL" Switch Drive. The drive pushes the "points" of the switch from side to side to change the direction of the switch.

Hint: An LGB manual switch can be converted into an electric switch by replacing the manual drive box with a 12010 Switch Drive. The conversion is simple. Just remove two screws to remove the manual drive box, and install the 12010 using the same two screws. The drive can be installed on either side of the switch, depending on your space requirements.

Up to four 12010 Switch Drives (or other EPL devices, like the 10560 Electric Uncoupler) can be controlled with one 51750 Control Box. The electrical connections are easy. Just follow the color coding

on the 51750. Connect the black and white terminals ("3" and "4") on the back of the 51750 to the black and white terminals ("3" and "4") on the back of any LGB power supply with AC output terminals.

Then connect one set of orange and white terminals on the 51750 Control Box to the orange and white terminals on the 12010 Switch Drive. Now you're in control. You can change the direction of the switch just by pushing a button on the box.

Hint: LGB color-coded cables, like 50130 Twin Lead Orange/White and 50140 Twin Lead Black/White, make EPL connections fast and easy. The wire is properly sized to fit EPL terminals, and the insulation is made to withstand outdoor exposure.

The 51750 is weather-resistant, and it can be installed outdoors without special protection. Mounting tabs on the base of the box make it easy to attach the 51750 to a table or control board.

Side posts, included with older 51750 Control Boxes and 51800 On/Off Control Boxes, make it easy to "piggy back" several control boxes together to make a large control panel. The posts are wired to the AC source (terminals "3" and "4") to eliminate the need for extra wiring to the power supply.

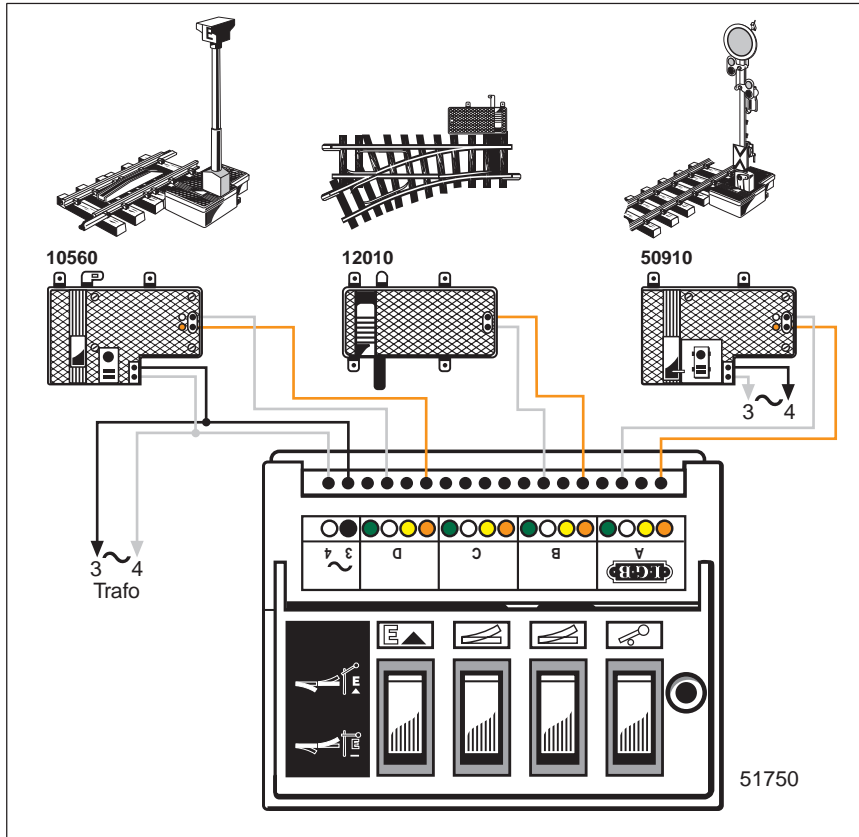



Signal Control: The LGB program also includes a variety of electric signals, in both European and American styles. Like LGB electric switches, most LGB electric signals include a 12010 "EPL" Switch Drive. The drive moves the signal indicators (colored flags or lenses) to indicate whether the train should stop or go.

Up to four signals can be controlled with one 51750 Control Box. In fact, you can use the same 51750 to control any combination of up to four switches and signals. The electrical connections are the same as for switches. Just follow the color coding on the 51750. Connect the black and white terminals ("3" and "4") on the back of the 51750 to the black and white terminals ("3" and "4") on the back of any LGB power supply with AC output terminals.

Then connect one set of orange and white terminals on the 51750 Control Box to the orange and white terminals on the 12010 Switch Drive. You can change the signal just by pushing a button on the box.

However, LGB electric signals are more than just signals. They can actually make your trains stop and go. Most LGB electric signals include a 12030 Supplementary Switch and two 10153 Insulated Tracks. The 12030 is a double-pole, double-throw (DPDT) switch that attaches to the end of any 12010 Switch Drive, and the drive operates the switch, much like a relay.

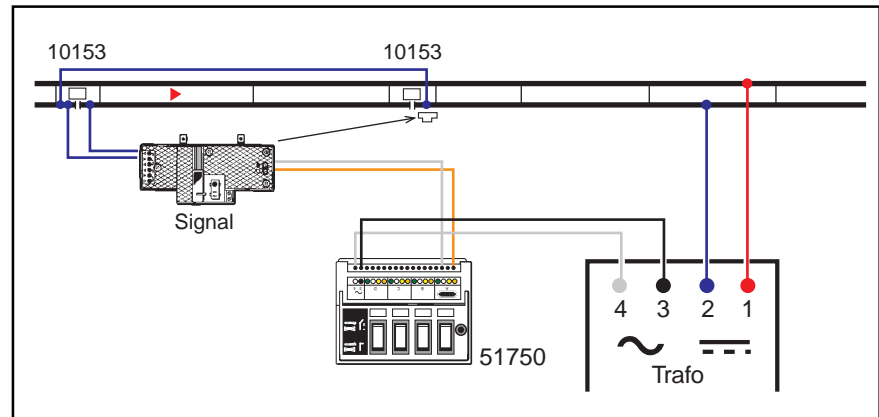

This arrangement lets you control the flow of power to an insulated track section between the two 10153 Insulated Tracks (Fig. 1a, 1b). Wire the signal to the second 10153 (depending on the direction of travel), and the signal can control the train. When the signal says "Stop," power to the insulated track section is turned off and the train will stop. When the signal says "Go," power to the insulated track section is turned on and the train can go. (See Chapter 10 for more information.)

The Accidental Loop

In this chapter, you have learned how to build many different LGB layouts with just a few different track sections. All of those layouts have advantages and disadvantages, but there is one layout with a big disadvantage: the reversing loop.

A reversing loop is an arrangement of track that reverses the direction of a train. For example, look at the reversing loop layout (Layout 17) here. A

train enters the loop traveling left to right and exits the loop traveling right to left.

In many situations, a reversing loop is helpful. For example, you could install a reversing loop at the end of a long main line to avoid the size and cost of a "double track" line. However, reversing loops create electrical problems because they create short circuits.

If you are aware of the reversing loop, you can solve those problems. (See Chapter 9 for more information.) Unfortunately, it's easy to create a reversing loop by accident. For example, this layout (Layout 18) was a simple oval until a line was added from one side to the other. That created a reversing loop. Trace the layout with your finger starting at Point A. Follow the layout through the diagonal section to Point B and Point C. Soon, you will return to Point A travelling in the opposite direction. The train has been reversed...and a short circuit has been created.

If you actually try to run a train on this layout—and if you have an LGB power supply—nothing serious will happen. All LGB power supplies have built-in short circuit protection, but you will not be able to run your train until the short circuit is removed.

Layout 17

9	10000
11	11000
1	12100

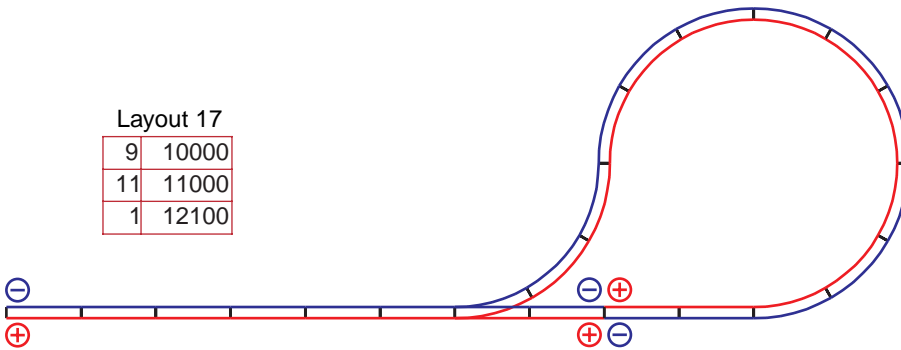

Layout 18

6	10000
16	11000
2	12100

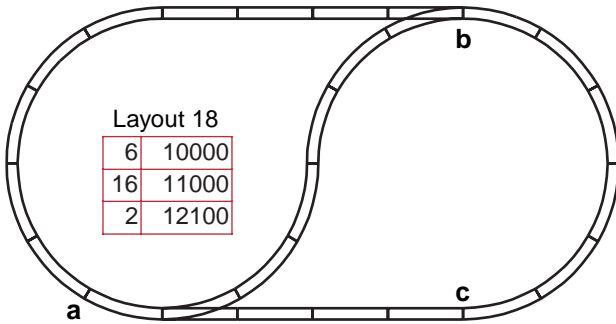

LGB Q&A

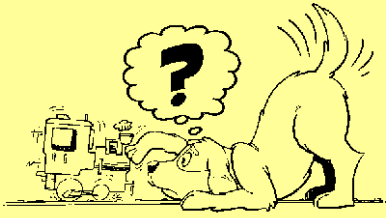

This motorized tender has built-in steam sound

Both the loco and motorized tender are hard at work in this painting by artist Peter Jerry for LGB Telegram magazine

How can I pull more cars?

Now that you have more track, you have room for more cars. But what do you do when your starter set loco won't pull all your cars? You could get a new loco with more pulling power. There are plenty of great locos—steam, diesel and electric models—in the LGB program. Or you could make your starter set loco more powerful with a matching LGB motorized tender.

In real life, tenders carry fuel and water for locomotives, but LGB motorized tenders have something extra. They include a Bühler motor and protected gearbox, just like a regular LGB loco. Add one to your starter set loco, and you have the pulling power of two locos. The LGB program includes motorized tenders, including some with built-in electronic steam sound.

Installation is easy. A special coupler hook, included with the tender, replaces the standard coupler on the back of some starter set locos. (You'll need a Phillips-head screwdriver to make this change. You'll find one in the 50020 Special Tool Set.)

Then couple the loco to the tender. An electrical jumper cable is also included to make an electrical connection between the tender and the loco. It will improve operation, especially on dirty track and over switches, but it is not required.

Speaking of electricity: To get more pulling power, you need more electrical power. The 1 amp power packs included in most newer LGB starter sets will provide enough power for a starter set loco and a motorized tender in most situations. However, the smaller power packs (0.5-0.6 amp) included in most older LGB starter sets will not (see Chapter 8 for more information).



Lang Garden Bahn: The Holiday Layout

Every December, thousands and thousands of LGB fans around the world assemble LGB layouts in their homes and around their Christmas trees in celebration of the holidays.

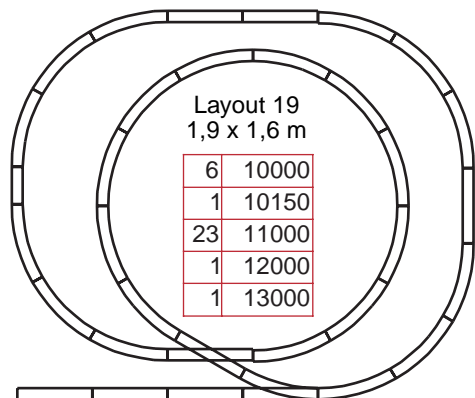

The Langs are doing the same with their new LGB train. To fit the layout in their crowded living room, the Langs have used a folded figure-eight layout plan with an LGB 13000 30° Crossing. An added stub siding lets the Langs park one train while running another. The entire layout features more than 10 meters (33 feet) of track in an area of less than 3 square meters (30 square feet).

Their glistening Christmas tree fits right in the center of the loop, making the train disappear and reappear as it passes behind the tree. That disappearing act creates an important visual illusion. The train appears to be going somewhere and then returning, unlike a "toy" train that only goes in circles.

Wherever it goes, the Lang's friends and neighbors love the train, especially when Heidi fills one of the freight cars with chocolates. When the holidays are over, Alex won't need any tools to take the layout apart...that is, if he ever does take it apart.



Discoveries: Christmas Fun for Everyone

Story by Paul E. Garrison

Photos by Charles F. Sibre

"Dave, I have no place to sit!" laments Hazel Howard to her son.

"Mom, go to your room!" Dave Howard replies.

There is next to no place to sit downstairs at the Howard's eastern Pennsylvania home from just after Halloween until mid-January. On the entire first floor—and on to the outdoor deck—is a floor-level train and toy display. Affectionately called the YT&TRW Line, it represents the railways and Christmas customs of Yesterday, Today and Tomorrow.



*The Howard's holiday layout
fills the first floor...and more*

Over 300 meters (1,000 feet) of LGB brass track weave in and out of the foyer, living room, dining room, kitchen and recreation room. The tracks continue through five tunnels in specially adapted Plexiglas sliding doors to the outdoor deck.

There are but a few rules to observe:

"Look before you open the refrigerator door so you don't derail the train" is one rule the Howard household has learned. Visitors—mostly children—are told there is no running, no tunnels to be made with their legs, and most important (and serious)—"Children must watch their parents!"

Dave's patient mother accepts the rationale that the "Toys and Trains" layout is great for her grandchildren. However, as many as 600 relatives and friends (all through personal invitations only) show up during the



"Look before you open the refrigerator door!"

three- to four-week Christmas season to share the fun with Hazel's grandchildren.

In the foyer is a 12-foot Christmas tree, with traditional decorations along with numerous miniature people, storybook and cartoon characters. "Where's Waldo?" a youngster from Tennessee asks.

"Matter of fact," Dave explains, "there are three of them" among the 300 plus characters in the display.

Underneath the tree chugs the first of seven LGB trains running simultaneously in the Howard display. The train is filled with a complete cast of Looney Tunes characters, including Bugs Bunny and Daffy Duck.

On to the living room, as Dave continues the tour intended to "bring happiness and pleasant memories to people of all ages." Here some of the 200 railroad cars chug by, carrying farm animals with appropriate sound effects for cargoes of chickens, turkeys and cows.

An LGB Mogul steam engine puffs through clusters of characters showing scenes from such film classics as "The Wizard of Oz," "101 Dalmatians," "E.T.," "Winnie the Pooh" and "Pinocchio." TV favorites are spotted—old and new—in tableaux with "The Simpsons," "Bullwinkle," "The Smurfs," "Howdy Doody" and "Raggedy Ann and Andy."

The dining room is "The Night Before Christmas," where a Grandma doll reads to the young'uns while they decorate their tree. Here, an LGB Circus Train passes through. It's led by two engines and features a calliope car playing circus music, an observation car filled with clowns and wild animal cars. One modified car carries giraffes peeking out of their roof hatch.

Dave's favorite locomotives—two big LGB Austrian diesels—lead us into the kitchen, then on to the recreation room. The refrigerator is out-of-bounds during the tour!

The lead locos pull ten LGB coaches. All are lighted and carry passengers of all descriptions—photographers, dogs and even an entire Cub Scout pack!

Thirty switches guide train routes as Spiderman climbs a high tension tower, Batman flies high above in a helicopter and Superman emerges from a phone booth. Forty Pennsylvania Railroad hand-made target signals keep a semblance of order.

It's out to the 12 meter by 6 meter (40 foot by 20 foot) deck as small pillows and blankets sealing the tunnels from wintry blasts are removed for the tour. Here is the seven-foot Ski Mountain, complete with moving cable cars. There are bridges, trestles, artificial and real trees. Dave uses his skills as a professional landscape architect to form a realistic bit of geography using 61 meters (200 feet) of chicken wire to support 122 meters (400 feet) of burlap.

Several times a day, a real freight train runs about 69 meters (225 feet) beyond the deck. Children accept these intrusions as part of the show.

It takes Dave some twelve hours to set up the wire and a full three days to staple the burlap to the deck to withstand the weather. Real ice sometimes hangs from the wires and tree branches. Burlap mountains and ski jumps can be truly snow-capped.

Dave's been collecting since 1974, when he picked LGB trains because "they run well indoors and outdoors." His first set was a standard black engine along with a Shell tank car and two ore cars on a four-foot track circle and no power pack. "LGB trains are top-of-the-line in quality and fine detail," Dave volunteers. "They run and run and run."

Dave has had offers to move his unusual display to nearby malls and office lobbies, but declines them all. "I want to maintain a home atmosphere," he says. "It's Mom's house," he smiles, "but it's my train set!"





CHAPTER 5: ON TRACK

LGB track sections work together for easy layout design, indoors or outdoors.

The LGB program includes more than 30 different track sections. Every one is ruggedly made with solid rails of virgin brass. Every one is constructed with weather-resistant ties of high-impact plastic. Every one is equipped with precision engineered, corrosion-resistant rail joiners.

And most of all, LGB track sections are designed to work together. For example, the standard 10000 straight section is the same length as the straight side of a 12000 switch. The curved side of the switch is the same length and radius as the standard 11000 curved section. So you can easily use LGB track sections together without creating a layout that looks like a bowl full of spaghetti.

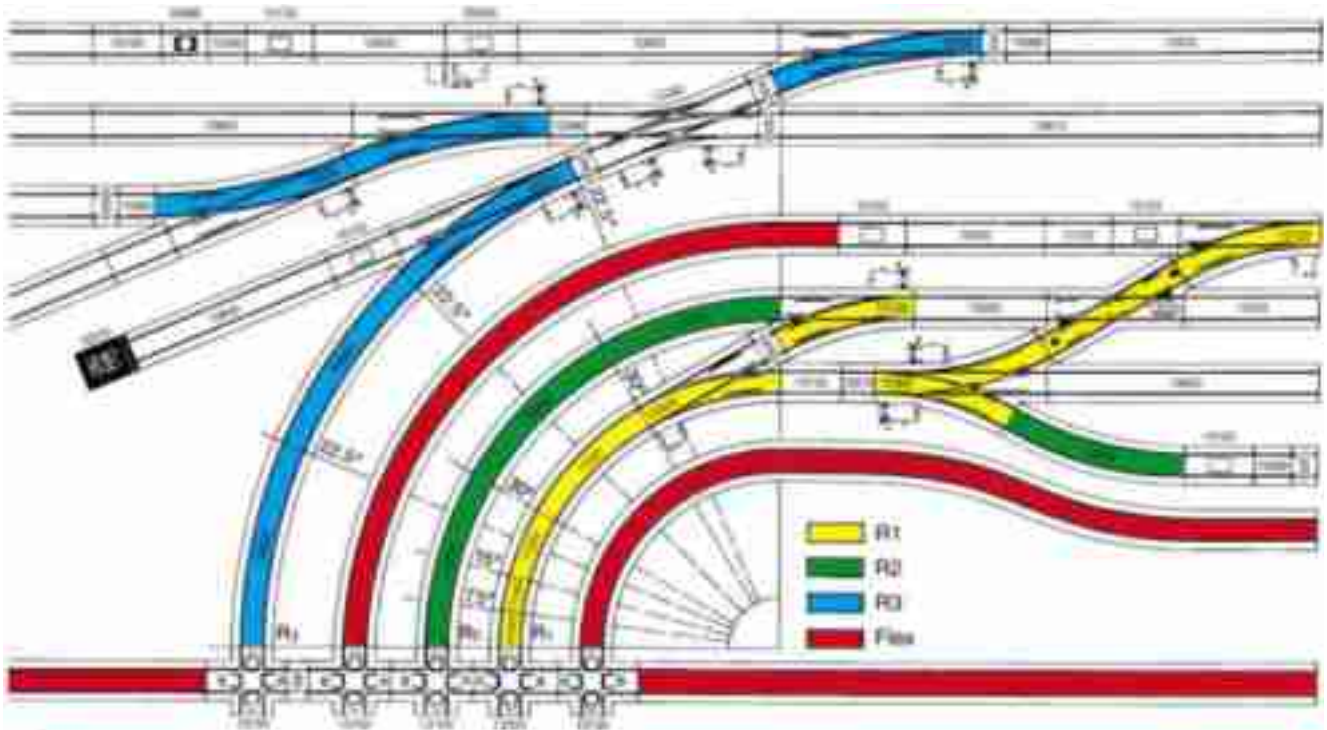

In this chapter, we'll help you understand the basic geometry of LGB track sections. To start, let's look at the five basic types of LGB track sections:

Straight Track Sections

LGB straight track sections are classified according to their length in millimeters:

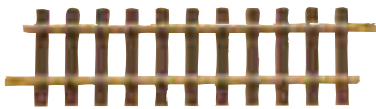

Number	Name
10000	Straight Track, 300 mm

This basic LGB straight section can be found in most LGB layouts. This section is sometimes called a "one foot" section.

10040	Straight Track, 41 mm
--------------	------------------------------

This short "make-up" section is frequently used in combinations with 12000 switches.

10050 Straight Track, 52 mm

This make-up section is frequently used with 12260 "double slip" switches and 13000 crossings.

10070 Straight Track, 75 mm

This make-up section is 1/4 the length of a 10000 straight section.

10080 Straight Track, 82 mm

This make-up section is frequently used in combinations with 12000 switches.

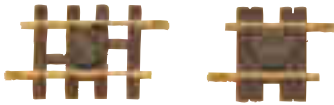

10090 Adjustable Track, 88-120 mm

The length of this section can be changed by turning the knob in the center of the section. It is very useful when building temporary layouts.

10150 Straight Track, 150 mm

This section is 1/2 the length of a 10000 straight section. It can be combined with another 150 mm track section, like an insulated track, to create a full 300 mm section.

10600 Straight Track, 600 mm

This section is 2 times the length of a 10000 straight section. This section is sometimes called a "two foot" section.

10610 Straight Track, 1200 mm

This section is 4 times the length of a 10000 straight section. This section is sometimes called a "four foot" section.

Curved Track Sections

LGB curved track sections are named according to their radius (R1, R2, R3) and arc in degrees:

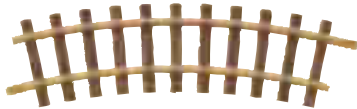

11000 Curved Track, R1, 30°

This basic LGB curved section is included in LGB starter sets. Twelve 11000 sections make a complete circle (12 sections x 30° = 360°).

11020 Curved Track, R1, 15°

This section is 1/2 the arc of an 11000 curved section.

11040 Curved Track, R1, 7.5°

This section is 1/4 the arc of an 11000 curved section.

15000 Curved Track, R2, 30°

This is a medium-radius curve. Twelve 15000 sections make a complete circle (12 sections x 30° = 360°).

16000 Curved Track, R3, 22.5°

This is a large-radius curve. Sixteen 16000 sections make a complete circle (16 sections x 22.5° = 360°).

Going in Circles

How big are all these track circles? From the start, Lehmann has simply referred to them as R1, R2 and R3, but over the years, there have been inconsistencies in the published measurements. We use these measurements:

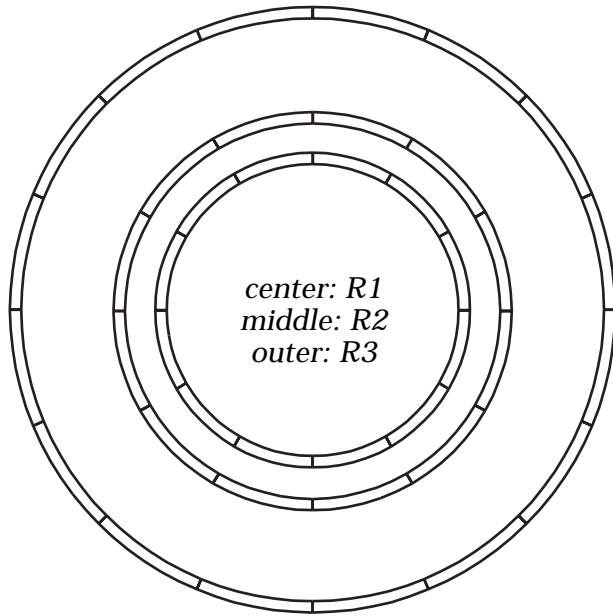

Radius Name	Radius Center-to-Center	Radius Center-to-Edge
R1	600 mm	645 mm
R2	778 mm	823 mm
R3	1198 mm	1243 mm

The "Center-to-Center" measurements are taken from the center of the circle to the center of the track section, halfway between the rails. This is the standard measurement for model railroad planning.

The "Center-to-Edge" measurements are taken from the center of the circle to the outer edge of the track section. This measurement will help you determine how much space your layout will occupy.

For example, if you want to build a circle of R1 track on a platform, the width of the platform must be double the Center-to-Edge radius: 1290 mm (50.8 in) .

(These measurements are only a guide. LGB track is somewhat flexible, and real life measurements will vary.)

Why does LGB make three different radius types? The small-radius R1 sections are good for fitting a lot of

track into a very small area. They're also good for building station and freight yards.

With extremely few exceptions, all LGB locomotives and rolling stock will operate on LGB R1 sections. However, longer trains will look better and run better on wider radius curves. Wider radius curves reduce "overhang" with longer cars and also reduce wheel friction, especially with large locomotives.

That's why the medium-radius R2 sections are a favorite with experienced LGB layout builders. R2 sections are broad enough for improved appearance and operation, but these medium-radius sections are still tight enough to fit in relatively small areas.

Large-radius R3 sections are used to create graceful, high-speed curves. They are a perfect choice for operating long equipment, like LGB's American streamline passenger cars or LGB's Rhätische Bahn "Glacier Express" cars. However, R3 sections also require a larger amount of space.

If you want even larger curves, you can use LGB "flex track" to create almost any radius or shape of curve you can imagine. (See Page 78 for more information.)

Switches

LGB switches, also known as "turnouts," are designated by their switch drive mechanism (manual or electric), curve direction (right or left) and curve radius (R1 or R3):

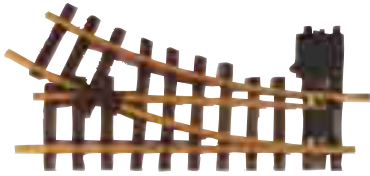

- 12000 Manual Switch, Right, R1**
- 12050 Electric Switch, Right, R1**
- 12100 Manual Switch, Left, R1**
- 12150 Electric Switch, Left, R1**

These four switches are essentially the same. For layout planning purposes, you can think of these as a combination of a 10000 straight section and a 11000 curved section. The electric versions include a 12010 "EPL" Switch Drive.

12260 Electric Double-Slip Switch

This special switch is a combination of a switch and a 22.5° crossing. The straight sections are 375 mm long. It includes two 12010 switch drives. The curves are R1 radius.

12360 Electric Three-Way Switch

This special switch is a combination of a 12100 and a 12150. The curved sides are R1 radius. It includes two 12010 switch drives.

16050 Electric Switch, Right, R3

16150 Electric Switch, Left, R3

The curved side of these switches is similar to a 16000 curved section. The straight side is 440 mm long. These switches include a 12010 switch drive.

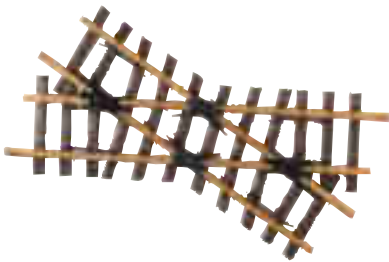

Crossings

LGB crossings are named according to their crossing angle (in degrees):

13000 Crossing, 30°

The straight sections of this crossing are different lengths, 300 mm and 341 mm.

13100 Crossing, 90°

The straight sections of this crossing are different lengths, 150 mm and 185 mm. This allows the 13100 to be installed in double track lines, for example, at a station.

Hint: The 185 mm section is not centered. One leg extends 82.5 mm from center. The other leg extends 102.5 mm from center.

The **12260 Electric Double-Slip Switch** is also a crossing with a 22.5° crossing angle.

Special Sections

The LGB program includes a variety of special sections that make layout building easier:

10003 Tie Section, 300 mm, 50 pack

10005 Rail Section, 1.5 m, 20 pack

These rails and ties can be combined to make your own LGB "flex track" sections. The two packages can be used to make 15 meters of track. You'll also need 10001 Metal Rail Joiners.

10151 Reverse Loop Track Set

This set includes two 150 mm straight sections. One of those sections (1015K) includes a special electronic circuit for simple reversing loop wiring. The other section (1015T) is a double-insulated section identical to a 10152. (See Chapter 10 for more information.)

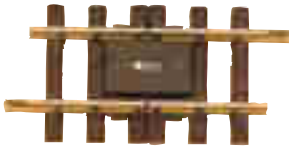

10152 Insulated Track, Double, 150 mm

This straight section is used to create electrically isolated track blocks. Both rails are insulated at the center of the section. A terminal block is concealed under a removable cover.

10153 Insulated Track, Single, 150 mm

This is the same as 10152, except only one rail is insulated.

10154 Activation Track, 600 mm

This straight section is used to operate LGB action cars, like the 41610 Automatic Unloading Gondola. It is controlled with a 51750 Control Box.

10320 American Track Bumper

This 300 mm straight section has a built-in bumper.

10560 Electric Uncoupler, 150 mm

This straight section allows you to uncouple LGB standard and knuckle couplers. It is controlled with a 51750 Control Box.

11152 Insulated Track, Double, R1

This is the same as 10152, except the section is curved. The radius of the section is R1, and the arc is 15°.



*LGB track sections and accessories work together... indoors **and** outdoors.*



Key to Track Plans

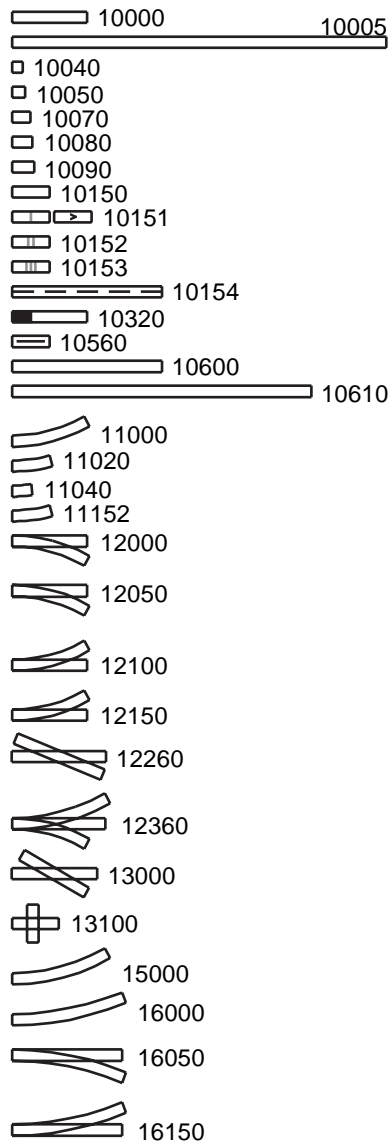

Here are a few hints to help you get the most out of the track plans in this guide...

- Unless indicated otherwise, the track plans in this guide are approximately 1:30 scale. That is, the real layout would be about 30 times larger than the plan.

- The track plans in this guide generally use 10000 straight sections. However, longer straights—like the 10600 and 10610—can often be substituted for runs of multiple 10000 sections. This reduces the number of connections and increases the mechanical strength of the layout.

- Most of the track lists in this guide specify manual switches. However, electric switches usually can be substituted for the manual switches.

- This 1:30 scale chart (left) includes all the track sections in the current LGB program. For updated information, visit your local LGB retailer.

- The track plans in this guide were created using a computer program (PCRail) in a perfectly level, perfectly assembled, perfectly perfect electronic environment. In real life, things aren't so perfect, and a bump in the carpet or a slope in the yard can change the geometry of your layout and the alignment of the track.

Don't worry. LGB track is flexible enough to tolerate reasonable discrepancies in track alignment. For example, compare the layout track plan to the layout photograph below. They use the exact same track sections in the exact same arrangement.

On paper, they don't fit. In real life, they do.

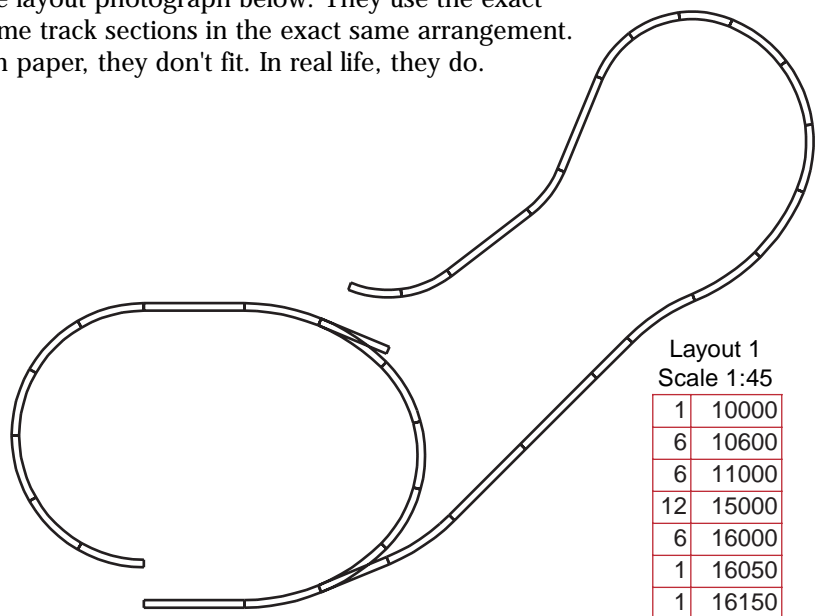

Track plans that don't work on paper sometimes do work in real life, as you can see with this Drew Marshall layout.

Basic Track Combinations

LGB track sections can be combined in an infinite number of ways, but there are a few basic combinations you can use like building blocks to create complex layouts:

10150 Exchange

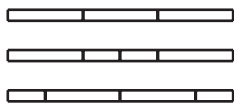

- **10150 Exchange.** This is a deceptively simple combination. Here, you see three sets of straight track sections. The first (top) is simply three 10000 straight sections together.

In the second (middle), the middle 10000 has been replaced with two 10150 sections. However, the middle 10000 could be replaced by any combination of any two 150 mm sections:

10150 Straight Track, 150 mm

10151 Reverse Loop Track Set (includes two 150 mm sections)

10152 Insulated Track, Double, 150 mm

10153 Insulated Track, Single, 150 mm

10560 Electric Uncoupler, 150 mm

The ability to mix and match these sections, without changing the overall length of the combination, is very helpful. For example, say you want to install an electric uncoupler in your layout. Simply replace the one 10000 section with the 10560 Electric Uncoupler and one plain 10150 section. That combination is the same length as the original 10000. You haven't changed the geometry of your layout.

In the third (bottom), one 10000 has been removed and replaced with two 10152s separated by the two remaining 10000s. In this way, you can use the 10152s to create an insulated track block, again, without changing the geometry of your layout. This combination is frequently used to create signal-controlled "stop" blocks.

12000 Siding



- **12000 Siding.** Like the 10150 Exchange, this combination lets you preserve the 300 mm length common to many LGB track sections. Here, a 12000-series switch is used with a 11000 R1 curved section and a 10000 straight section. Notice that the ends of the 10000 and the 11000 are perfectly even. This allows you to build sidings without changing the basic geometry of your layout (see below).

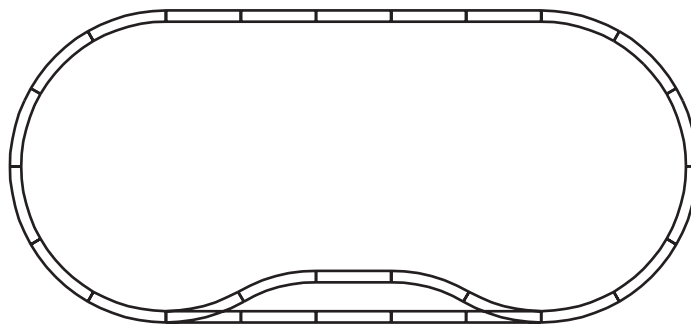

Also, this combination creates a distance of about 165 mm (center-to-center) between the siding tracks. This 165 mm spacing is common to many layout designs. However, there are several typical spacing distances (all distances are approximate):

150 mm - This spacing can be used for straight yard sidings. This spacing can create clearance problems, especially on curved track sections.

165 mm - This spacing can be used for sidings and stations of all kinds. 50340 Station Platforms will fit in sidings with this spacing.

185 mm - This spacing is used to create large, impressive stations, usually with 16000-series curved sections and switches. 50340 Station Platforms will also fit in sidings with this spacing.



Expanded 12000 Siding

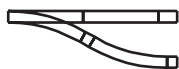

Double-Track Crossover



Curved-Entry 12000 Siding

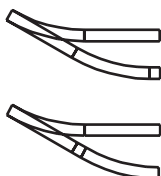

Double-Track Curved Crossover

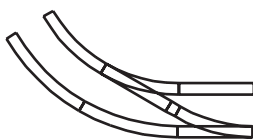

Left-Hand 13000 Crossing

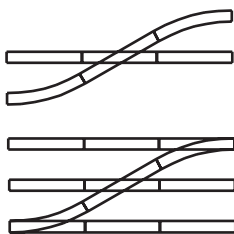

Right-Hand 13000 Crossing

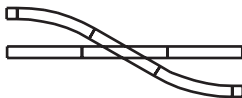

• **Expanded 12000 Siding.** This combination uses straight make-up sections to make sidings with 185 mm spacing using 12000-series switches. Two 10040 make-up sections are used on the curved leg of the siding. A 10070 section is used to make the straight leg approximately the same length as the curved leg.

• **Double-Track Crossover.** Frequently, you will want to move trains from one route to another, for example, from one oval to another. This combination, using two 12000-series switches, makes it easy to do that. A crossover is similar in construction to a siding, and it can be expanded in the same fashion to meet different spacing needs.

• **Curved-Entry 12000 Siding.** As your LGB empire grows, you'll want long sidings for storing and operating long trains. Unfortunately, long sidings take a lot of space, but you can build longer sidings with this combination. The entrance to the siding is on a curve, like the curve into a station. A 10040 make-up section is used to align the track ends.

The track spacing with these sections is approximately 150 mm or 165 mm. For 150 mm spacing, install the 10040 at the end of the 11000 curved section. For 165 mm spacing, install the 10040 between the switch and the 11000 curve.

• **Double-Track Curved Crossover.** This sounds very complex, but it's actually fairly simple and very useful. Here, parallel 11000 and 15000 curved sections enter the station. Replace the final 11000 section with a 12000-series switch and add one 10040 make-up section, then place another switch in the outer track. The result is a compact connection between the two parallel tracks. This combination is very useful when designing double-track layouts for two-train operation. The spacing between the tracks is 165 mm.

• **Left-Hand 13000 Crossing.** The 30° 13000 crossing is not symmetrical. One straight section is 300 mm long. The other section is 341 mm long. This creates two possible installations, known as "left-hand" and "right-hand." (Don't ask why.)

In the left-hand installation, the 300 mm section of the crossing replaces a 300 mm 10000 straight section. Then, the 341 mm section has the same geometry as a 12000 switch. Add two 11000 curves, and you have parallel tracks with 165 mm spacing (top). Or add two 12000-series switches, and you have a switchable combination of parallel tracks (bottom) that would look great in a station yard.

• **Right-Hand 13000 Crossing.** Like the left-hand installation, the Right-Hand 13000 can be used to create parallel tracks with 165 mm spacing. However, the 341 mm crossing section is now the "straight" section, making the entire combination 41 mm longer. 10040 make-up sections will be needed to make the outer tracks the same length.

Hint: For illustration purposes, we've used make-up sections to align the ends of the tracks in our track combinations. That makes it easier to combine multiple combinations into complex layouts. However, you don't have to do that. You can just add make-up sections as you build your layout to get the alignment you want.

Three-Way Switch

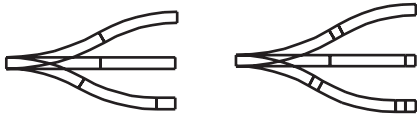

• **Three-Way Switch.** The 12360 Electric Three Way Switch is a blessing when you want a lot of sidings in a small area. Installed end-to-end, a 12050 right-hand electric switch and a 12150 left-hand electric switch are 600 mm long. A 12360 performs the same functions as those two switches, but it is only 375 mm long.

The 12360 accomplishes this trick by partially overlapping a right-hand switch and a left-hand switch. The right-hand switch starts first, and then, the left-hand switch begins 75 mm later.

The curved sections of the 12360 are the geometric equivalent of 11000 curved sections, and so, the 12360 can be used with 11000 sections to create sidings with 165 mm spacing (left). A make-up track can be used to account for the greater length of the 12360. Make-up tracks can also be used to increase the track spacing (right).

16000 Siding



• **16000 Siding.** Here a 16000-series (R3) switch is used with a 16000 curved section to create a wide radius siding. The track spacing in this combination is 185 mm. The 440 mm length of the 16000-series switches does not correspond with any single straight section. Two 10080 make-up sections can be used to align the individual tracks.

Curved-Entry 16000 Siding

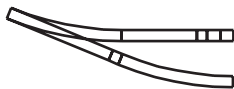

• **Curved-Entry 16000 Siding.** Like the Curved-Entry 12000 Siding, this combination is useful for building stations in small places. A 10040 make-up section is used to maintain 185 mm track spacing.

Hint: The gradual transitions in 16000-series sidings offer improved appearance and operation, especially with long locomotives and rolling stock. If you have the necessary space, these sidings are recommended over the smaller 12000-series sidings.

Double-Slip Switch

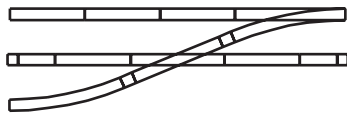

• **Double-Slip Switch.** The 12260 Electric-Double Slip Switch is both a switch and a crossing. When operated "straight," trains pass straight across the crossing. When operated "curved," trains are diverted to the left or right on a curve, just like a switch. The curved sections share the same 22.5° arc as the 16000-series curved sections but are R1 radius. The straight sections are symmetrical, both 375 mm long.

When used with 10050 make-up sections, the 12260 can be combined with 16000-series sections to create parallel tracks with 185 mm spacing.



Basic Layout Designs

Now that you have your building blocks, you're ready to start building your layout. But what kind of layout should you build? There are dozens and dozens of layouts in this book alone. There are thousands of layouts in other books and magazines, and there are tens of thousands of LGB layouts in homes and gardens around the world.

Don't panic. The good news is that there are only three basic types of model railroad layouts:

Point-to-point layouts. On a point-to-point layout, the train starts at one end of the layout and stops at the other end. A point-to-point layout can be as simple as a straight section of track. The train starts at Point A and stops when it reaches Point B.



Most real railroads can be called point-to-point layouts. For example, a real train may travel from New York to Los Angeles or from Paris to Istanbul. However, point-to-point layouts are not as common on model railroads. Why? Because trains will not run continuously on point-to-point layouts without operator assistance or special equipment. Once the train arrives at Point B something has to happen to make it return to Point A. You could simply run the train in reverse, and that's good for double-ended vehicles, like railbuses and streetcars.

Hint: An LGB automatic reversing unit makes it easy to operate double-ended vehicles on point-to-point layouts. This electronic device continuously runs the vehicle from one end of the layout to the other. For more information, see the LGB catalog.

However, regular trains, with locomotives pulling rolling stock, don't look good or operate well in reverse. To solve that problem, you can build a point-to-point layout with stations at each end, like Layout 1. The train leaves Station A and goes to Station B. At Station B, the locomotive is uncoupled from the train and moves to the other end of the train using the passing siding.

Then the train returns to Station A, and the process is repeated. That's a good solution if you prefer to operate your trains rather than watch them run.

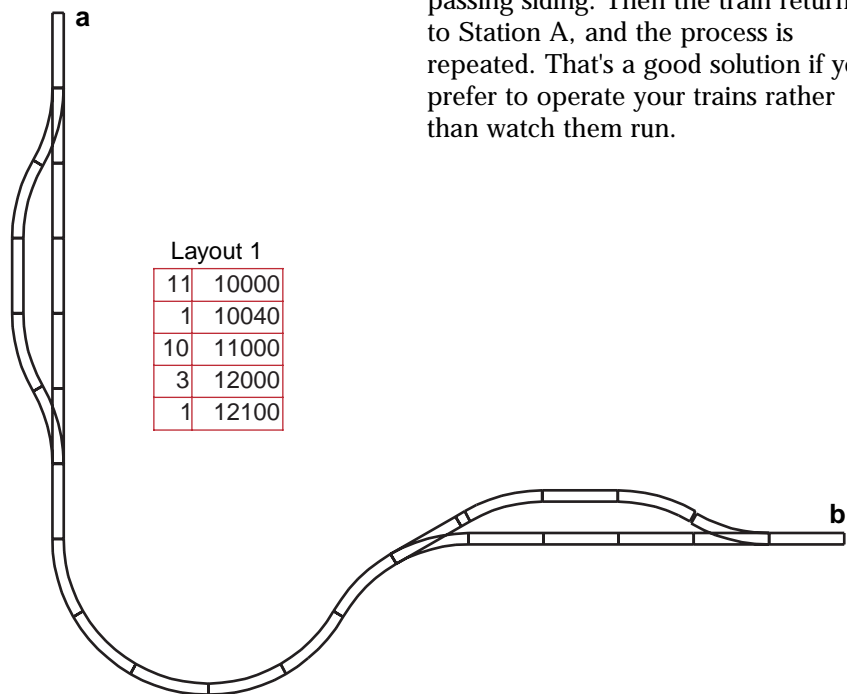

And for more operations, you can add more sidings and more stations. With this point-to-point layout (Layout 2), you can switch locomotives, assemble trains, pick-up loads and drop cargo, just like on a real railroad.

This doesn't look like a point-to-point layout, but it is!

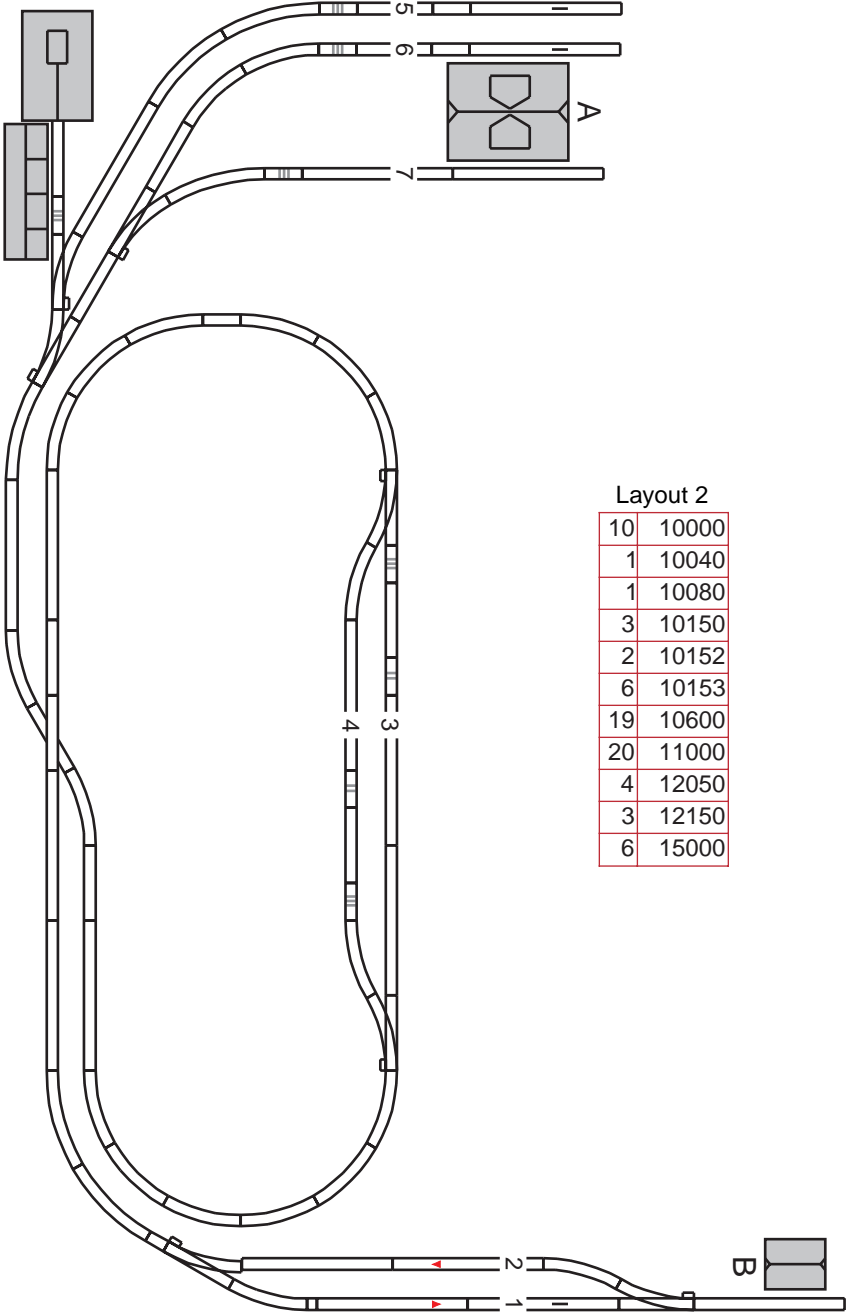

Oval Layouts. On an oval layout, a train can run continuously in the same direction. An oval layout can be as simple as a circle, but there are

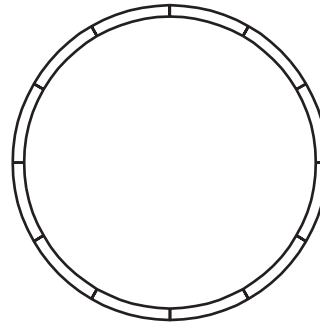

millions of variations on that simple theme. For example, this "figure-eight" layout (Layout 3) is a twisted oval. The big "dogbone" layout (Layout 4) is a squeezed and folded oval.

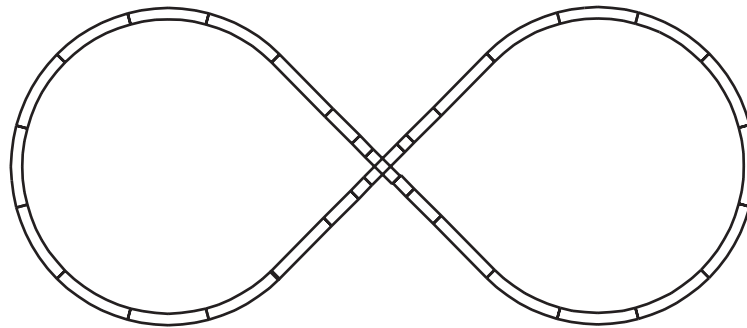

Layout 3

4	10000
1	10050
3	10070
4	10150
18	11000
1	13100

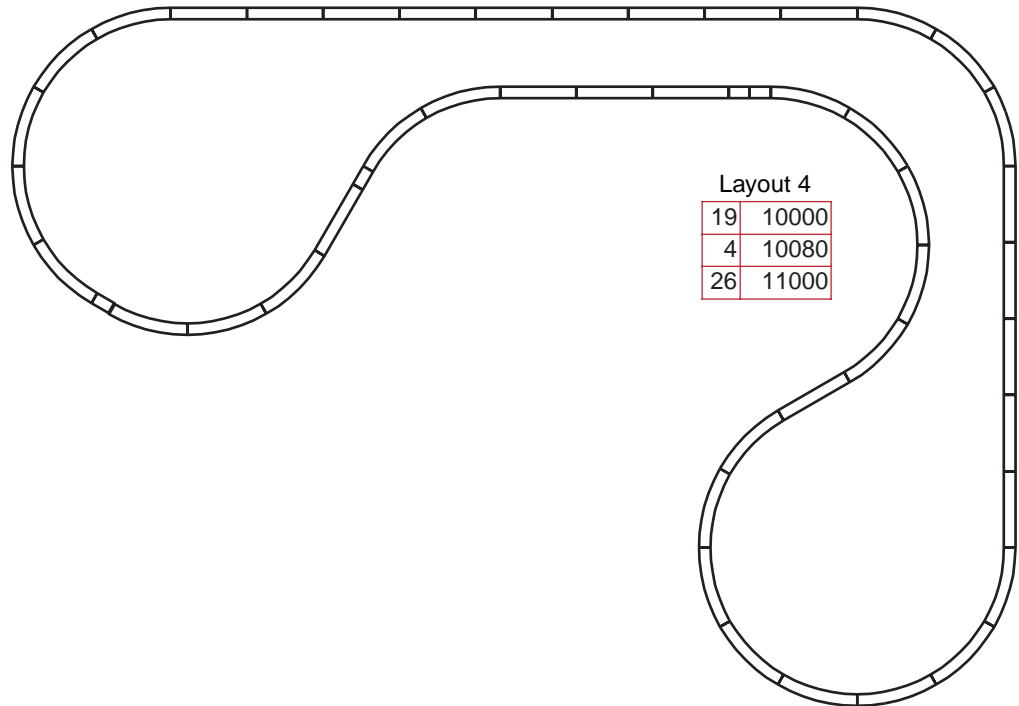

Layout 4

19	10000
4	10080
26	11000

An oval can also provide as many operating possibilities as point-to-point layouts. For example, this big oval (Layout 5) is a folded figure-eight with a big passing siding and four stub sidings. With it, you can have lots of operating fun, but since it's still an oval, you can just sit back, relax and watch the trains run.

The one disadvantage of oval layouts is their size. At a minimum, every oval layout must include a full circle of track for continuous operation, and no matter how you bend or shape it, an oval layout will always be at least two tracks wide. That's a problem, especially in situations where the track has to run along walls or fences.

Layout 5

12	10000
2	10080
7	10150
2	10152
7	10153
20	10600
31	11000
2	12050
4	12150

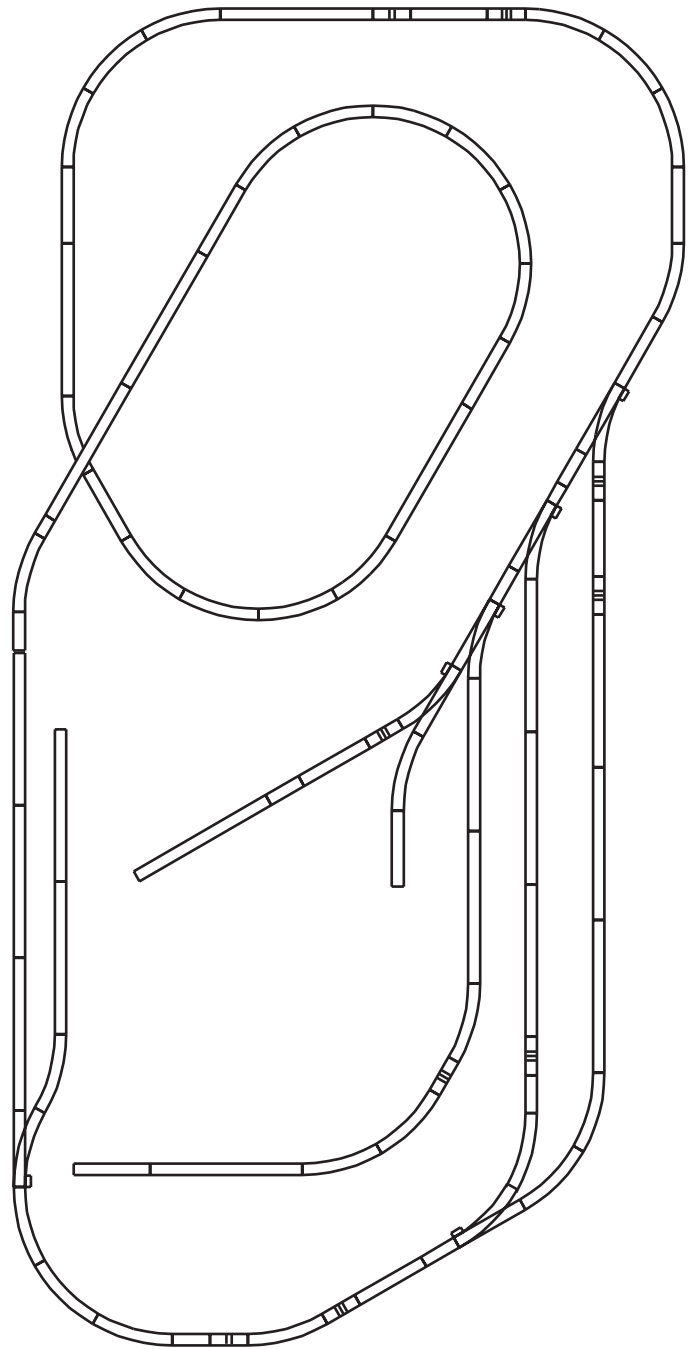

Reversing Loop Layouts. The solution to the double track problem is the reversing loop. On a reversing loop layout, a train enters a loop traveling in one direction and exits the loop traveling in the opposite direction. For example, in this simple loop (Layout 6), a train enters the loop traveling left to right and exits the loop traveling right to left.

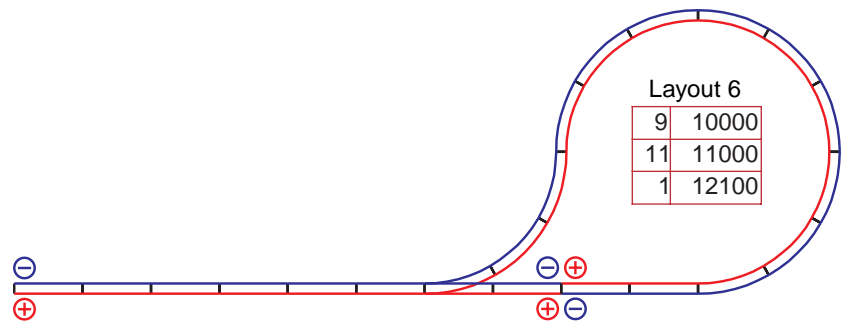

If you combine two reversing loops (Layout 7), you get continuous operation with a single track connecting the loops. You get the flexibility of a point-to-point layout with ease of an oval layout.

Attention: Reversing loops create electrical problems because the reversed rails cause short circuits. The LGB program offers a variety of solutions to these problems, but these solutions require a bit of extra thought and planning. (See Chapter 9 for more information.)

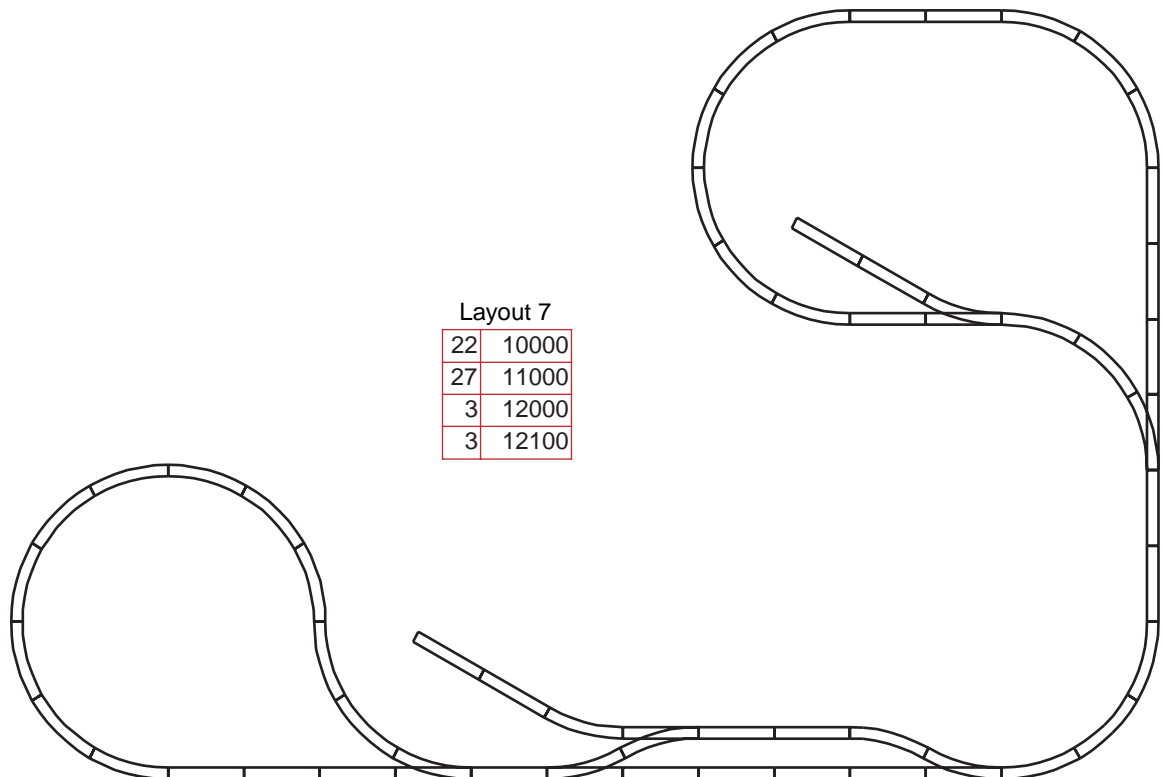

Layout Planning Tools and Tips

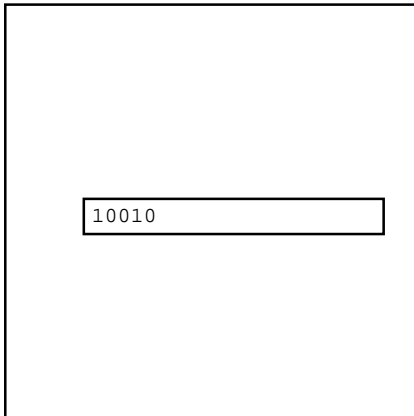

Here are some tools to help you plan your LGB empire:

- The 10010 LGB Track Planning Template is a durable plastic stencil with 1:10 scale cutouts for tracing LGB track sections. The template includes most track sections in the LGB program.

Use a fine point pencil, like a 0.5 mm mechanical pencil, to draw each track section. Use the alignment marks on the template to leave a 2 mm gap between each section. R1, R2 and R3 arcs make it easy to draw properly aligned curves. Scale rules (1:10 and 1:22.5) on the edges of the template allow accurate measuring.

- The chart below shows some common combinations of LGB make-up track sections. For example, if you need to fill a straight 126 mm gap between two tracks, look down chart column marked "Length." The closest to 126 mm is 127 mm, which the chart indicates can be made by combining one 10050 and one 10070 track section.

Length (mm) Track Combination

41	10040
52	10050
75	10070
82	10080
93	10040+10050
104	10050+10050
116	10040+10070
123	10040+10080
127	10050+10070
134	10050+10080
145	10040+10050+10050
150	10150

- Several software makers offer layout planning programs that make it easy to assemble large layouts without drawing...and without erasing. For this book, we used PCRail, which includes libraries of LGB track sections and G-scale buildings. Other layout planning programs include CADrail, WinRail, XtrakCad and 3D Railroad.

Now that you have your tools. Here are some track planning tips from LGB experts:

- Keep it simple. Complex layouts—track plans with a large number of switches, sidings and curves—are more difficult to build and maintain, especially outdoors.

- Use R2 and R3 curves. Trains look better and run better on wider-radius curves.

- Avoid S-curves. Back-to-back curves turning in opposite directions can provoke derailments, especially with R1 curved sections. Install a straight section, preferably as long as your longest car or loco, between the curves.

- Make sidings as long as possible. As you acquire more trains, you'll want longer sidings for operating and storing those trains.

- Make the track accessible. Avoid installing track sections, especially switches, where they will be difficult to reach for cleaning, maintenance and accident recovery.

- Experiment. Get some track and try different configurations in different places. You'll discover things you might never see on paper.

Always keep in mind that track planning is not an exact science. A layout that is perfect on paper may not be perfect in a garden full of rocks, roots, grades and gutters. When you're ready to build, have some extra track sections, including some make-up sections, to smooth out those minor imperfections.



Discoveries: Beyond the Starter Set

Story by Drew Marshall

Graphic by Frances Buffington



The majority of articles about LGB model railroading are about large, elaborate layouts or projects that are great for inspiration, yet are too intimidating to motivate the average reader to get started, to get beyond their starter set. That's not what you'll read about here!

The basics

It is important to begin with a basic layout philosophy. It is often said that the Number One rule of model railroading is: "This is my railroad, and what I say goes."

Using that philosophy, it is perfectly all right to fix your LGB empire to a small piece of green plywood, running in a simple loop, and pulling a German old-time passenger car and an American wooden freight car with a Swiss rack locomotive.

On the other hand, you can research one particular line at one point in time, meticulously recreating the scenery, structures and equipment down to the proper car numbers, all in exact scale and detail.

Spend a little time pondering just how you want to enjoy your trains—today, tomorrow and later on. It is best to start simple and manageable, leaving room for changes and expansion later on.

Run your trains on the floor inside

This is usually a temporary use, although many people leave their LGB permanently on the carpet in their house. More than one nice LGB layout has developed after someone put a simple loop down on the floor.

Rather than putting an oval of track in the center of the living room, consider a route that travels more of the perimeter of the room. After all, the first six inches of floor from the wall is usually unoccupied and nearly impossible for you to stand in. If a few pieces of furniture are close to the wall, just move them out a few inches. A train traveling behind sofas, chairs, beds and dressers really seems to go somewhere! The amount of track that has to go in walking areas is usually minimal if planned well.

This layout occupies very little walking space, and the train can quickly be stored behind the sofa.



*You can put LGB anywhere.
This shelf layout is in a Cairo
donut shop.*



The bold LGBer (with appropriate spousal approval) may even elect to cut a few tunnel portals between rooms. One enthusiast, after running track from room to room, politely asked his wife to remove her dining room table from his train room! She complied. When he was questioned as to where they have meals now, he responded “We eat out a lot.”

Run trains around overhead

A wonderful way to display your train is around the room on a shelf or similar structure. There are many methods to accomplish this, in a very wide variety of price ranges. It need not be elaborate or costly, just a simple shelf around a room above the windows and doors.

The shelf is up and out of the way, yet the large size of LGB allows for good viewing. You can use the layout to showcase your favorite train on a roadbed to blend with the decor, or decorate the layout in a variety of ways, with mountains, murals and other scenery.

Put trains on the porch, patio or deck

Most homeowners don't use their patio space as often or as extensively as they had planned. Laying tracks in that area makes use of infrequently utilized space, and also forces avid LGBers to enjoy one of the more peaceful areas of their domicile more often. Sitting on the porch with a relaxing beverage or snack as trains meander about is one of the finest ways to appreciate the therapeutic benefits of LGB!

Design and construction is very much like what may be done inside, but it is often easier to obtain “creative household zoning” for deck-type areas. In this stage, it is not uncommon to see more buildings and scenery added to the empire than indoors.



Your garden layout doesn't even have to be in a garden. Anywhere outdoors will do.

Build a simple garden layout

There are countless styles of garden railways. A good way to get started, though, is to think small and simple with expansion later on.

Put aside those grand and glorious thoughts of an LGB garden empire for today. Take a thoughtful walk around the yard, looking at every single area with a new frame of mind. Chances are there is an ideal spot to get started right under your nose.

Pick a bed of shrubbery or flowers that is fairly level. Get some loose track and see just where the train can go. Trim a few branches here or there, tunnel through a bush or two. Push a little dirt or mulch around to support the track. You can worry about permanent roadbed later.

Go grab an engine and power supply. You will be amazed how quickly (a matter of a few hours) a garden railway can get started. Put in a couple of turnouts to allow for future expansion if you want, but concentrate on a simple loop for now.

You can run down to the local garden shop for some appropriate plants if needed, or set out a building or two. Don't forget to add some people—they can really bring a railway to life.

The quickest way to get started, though, is just get the train running around what is out in the garden already. Many layouts are simply tracks running through flowers, plants and rocks. Others credibly recreate scale scenery in a whole little world. Some have water features, others lots of rocks.

Create a traditional model railroad

Just because these trains are constructed with garden railroading in mind does not imply that an outdoor layout is for every LGB fan. If you do not enjoy working outdoors on a hot summer day, pulling weeds and getting dirty, maybe indoors is the place for you to be.

While LGB is large, the tight radius possible with narrow gauge equipment allows for an indoor layout in less space than you may realize. A spare bedroom, covered porch, garage, basement or other space in your home should be a fine spot to construct an LGB layout.

One LGBer sold off the living room furniture, hired a carpenter to build cabinets around the wall, and now has a beautiful layout encircling the previously little-used formal room (a two-track hinged bridge spans the doorway).

Your local hobby shop should carry a myriad of books on benchwork, trackwork, scenery and more to get you going in the right direction. Methods for smaller scale railroads work just as well on our large trains.

But Remember...

However you do it, it is important to be sure you are enjoying the trains. There are not many wrong ways to go about it. But if you are not having fun with a particular phase of building or operating, chances are it may be the wrong way for you to do it, even though someone else does it that way.

Many a model railroader has made the mistake of biting off more he can chew. Remember that this is a hobby. Have fun!

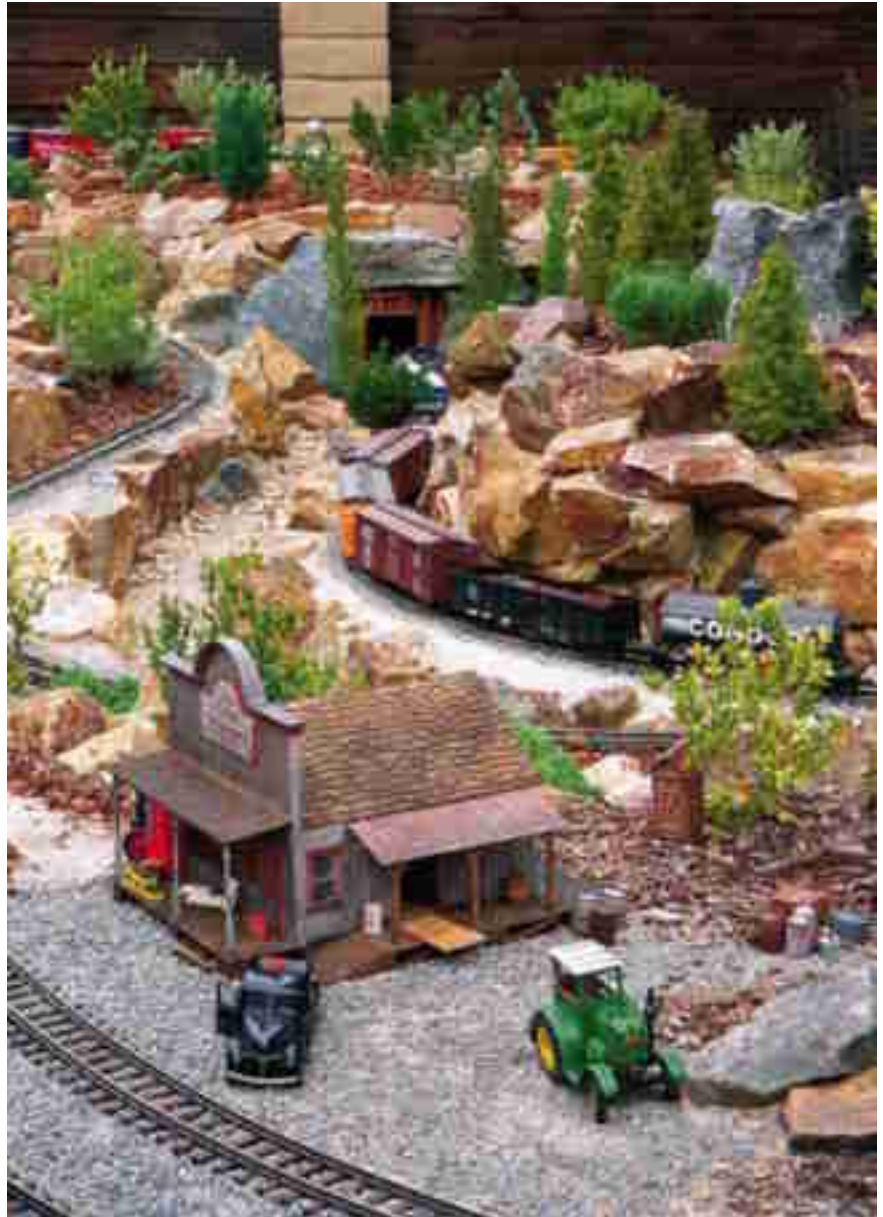

CHAPTER 6: WORKING ON THE RAILROAD

*Stop planning and start
building your own LGB layout!*



Laying Track Outdoors

For weeks, you've worked on your layout plan. You've thoughtfully considered different designs, and you've carefully purchased all your track. You know what you want to build, but how do you actually build it?

In this chapter, we'll give you some practical techniques and useful tips for layout building. These ideas will help save you time...and perhaps some money. However, the most important tip is this: Get started! The fear of making a mistake is usually much greater than any damage caused by the mistake itself.

If you ask a dozen different garden railroaders how to install track outdoors, you will get at least a dozen different answers. Different techniques work well for different people in different situations, but there are several techniques that have proven effective around the world:

Track on Grass

When you're getting started, keep it simple. Just put the track on the grass in your yard. If the track is well supported, normal foot traffic will not damage LGB track, and with a bit of care, you can even drive an automobile across LGB track.

LGB track is flexible enough to handle small undulations in the ground, and larger variations can be handled with simple materials, like wooden blocks. In this example, the track has been raised above the ground with a 5 mm aluminum wire bent into a "U" shape. It will support the track for short distances, and it is easy to install and remove.

The "track on grass" method is usually only for temporary layouts, but it is an excellent way to learn about outdoor railroading and about your yard. Where does the sun shine in the evening? How steep is that slope? Where did all those leaves come from?

Track on Wood

Wood is a very common material, and so the "track on wood" technique is very popular. Make a roadbed using wooden planks at least 120 mm (5 in) in width. For permanent installations, the planks should be weather and insect resistant.

Straight sections are made with longer planks. Curved sections are made using short planks cut at matching angles. Then, attach the track to the planks using small nails or screws. (Larger LGB track sections have small nail holes molded in the center of selected ties.)

If you have some ability with a saw, a hammer and nails, you can quickly assemble an outdoor layout with wooden roadbed. Also, with this technique, you can easily create grades and overcome obstacles.

There are several drawbacks to the "track on wood" method. Treated wood is relatively expensive, and over time, even treated wood may warp or decay. Also, many dislike the appearance of the wooden planks. However, the planks can be concealed by spreading ballast (small stones) on the track and by covering the edges of the planks with garden plants and mulch.

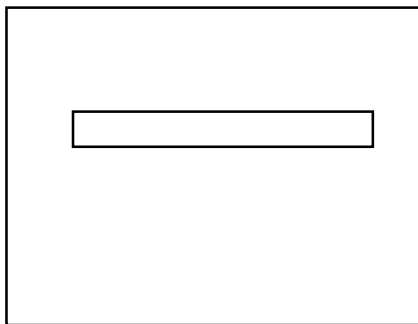
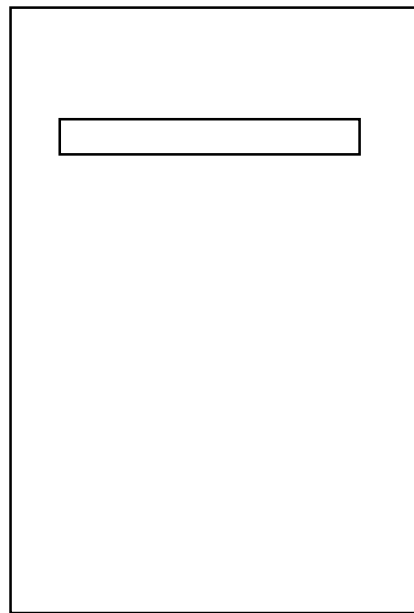



Real railroads, like Switzerland's BLM line, float their track in a bed of ballast.

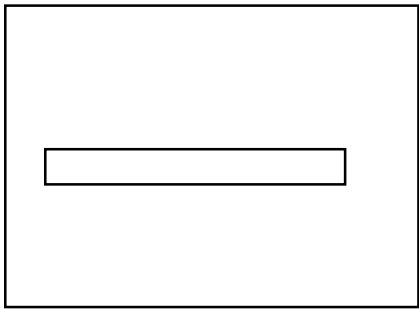

Use a wooden block as a guide for digging a trench.

Floating Track

Most real railroads use this technique, and we recommend it for most permanent garden railways. Instead of using a rigid roadbed, the track "floats" in a bed of small stones, known as "ballast."

To construct your layout, follow these simple steps:

- Place the track on the ground to determine the route
- Dig a trench along the route using a wooden block as a guide. The depth of the trench is not critical. In fact, many people have successfully used this technique without digging any trench at all.
- Cover the bottom of the trench with a weed barrier. Plain plastic sheeting will work, if you punch occasional drainage holes in the sheeting. There are specialized fabrics, available at many garden stores, that will block weeds while allowing water to flow through the barrier.

Also, you can use lawn edging materials, metal or plastic, to line the sides of the trench. This will help keep the ballast on the track and the grass off the track.

- Fill the trench with crushed stone. In this example, coarse stone is used on the bottom of the trench, and smaller stones are used directly under the track.

The critical specification is the size of the stone ballast under the track. It must be small enough to fit around the track ties. However, if the stone is too small, it can become lodged in the track, especially in the moving parts of switches. Also, avoid rounded stones. Sharp-edged stones naturally lock together to hold the track securely.

Different stone sizes and materials are available in different parts of the world. Look for stone about 6 mm (0.25 in) in diameter. In North America, many farm supply stores sell gravel in this size as "turkey grit" or "chicken grit." In Germany, look for stone called "vierer Körnung." Because specifications vary from region to region, experiment with small quantities before you order a truckload of stone.

- Place the track on the stone and then sprinkle more stone on top of the track.
- Lift the track partially out of the stone and gently shake the track from side to side. When you are finished, the ties should be surrounded, but not completely covered, with stone.
- Gently spray the track with water to wash away dust and settle the ballast.
- That's it. You're ready to run!

The floating technique has many advantages. First, it requires no special skills or tools. If you can handle a shovel, you can use this technique. Second, it's durable. The track is free to expand and contract. Storm runoff can flow through the roadbed without causing damage. Third, it's flexible. If you want to add another switch or change the route of a curve, it's easy to remove the track and pour some more stone. Minor height adjustments can be made simply by lifting the track out of the stone or pushing it into the stone.

Hint: Use a small spirit level to make sure the track is level from side to side.

The most important advantage of the floating technique is that it looks good. It makes your layout look like a real railroad...because it is like a real railroad. Outside of stations, most full-size railroads float their tracks in a bed of stone.

In fact, you can learn a lot about this technique by visiting a real railroad. You can learn how railroads "superelevate" curves by lifting the outside rail slightly higher than the inside rail. You can learn how railroads avoid water



From left to right, this illustration shows the steps of the floating track technique.

runoff problems by installing culverts under the track. You may even see one of the real-life machines that shake the track in the ballast, just as you did on your garden railway.

Disadvantages? Since the ballast is loose, it can move. After a hard rainfall or the spring thaw, you may have to replace some ballast and level the track again. Similarly, the track can be jarred easily by clumsy feet. You may have to clean ballast out of switches to prevent the stones from interfering with the moving parts.

Finally, since the ballast is on (or in) the ground, you cannot use this technique alone to create grades. You could, for example, add or remove soil to create a grade. You can combine the "track on wood" and the "floating" techniques to suit your needs. For example, you can use wooden roadbed to create elevated structures like grades, bridges and stations. Then, you can use the floating method at ground level.

Track on Screen

This technique is a fascinating blend of indoor and outdoor layout building methods. As with many indoor layouts, you build a wooden grid to support the layout above the ground. Instead of attaching the track to the grid, you cover the frame with metal screening material, and then put the track on the screen. Finally, cover the exposed areas of screen with a layer of ballast.



This technique has many advantages:

- The layout is elevated above the ground. It's easier to assemble, view and maintain.
- Since the track isn't attached, it can be easily moved and changed.
- Wiring can be easily routed under the screen.
- Potted plants can be easily "planted" through holes in the screen.
- The ballast conceals all signs of construction and wiring.



• Water passes through the ballast and screen. The layout is cleaned every time it rains.

This technique is excellent in situations where you have a railing or fence to support the wooden grid and to provide a natural visual boundary for the layout. The layout shown here is on the balcony of the home of Ernst Wymann. The back of the grid is attached to the railing about 500 mm (20 in) above the ground. The front of the grid is supported by wooden posts. The underside of the grid is concealed by rounded wood planks, which can be lifted off for maintenance.

The entire Wymann layout is divided into three electrically isolated track blocks powered by three LGB transformers and speed controls. As required for safety, the house-current transformers are located indoors, and the layout is connected to the transformers via an eight-wire cable (three pairs of DC wires for the speed controls, one pair of AC wires for switches and accessories).

Room to Grow

When you lay track outdoors, no matter what technique you use, give your track room to expand. Why? Railroad rails—both real steel rails and model brass rails—expand and contract as the temperature rises and falls. For indoor layouts, this is not an issue because the temperature changes are small. However, in many climates, outdoor layouts can experience seasonal air temperature variations of 50° C (90° F) or more. With that change, 1 meter of brass rail will expand about 1 mm, and a layout with 100 meters (328 feet) of track will become 100 mm (4 in) longer.

Under pressure from the expanding and contracting rails, the track ties will shift small distances side-to-side...that is, if the track sections are loosely attached. If the track sections are very rigidly attached, the ties cannot shift. Then, the rails will warp, and under extreme conditions, the rails will spring out of the ties.

If you are using a rigid roadbed, like wooden planks, do not fasten every track section to the track. Instead, fasten every second or third section. Or leave a very small gap (less than 1 mm) between the rails every meter or so. Except in very moderate climates, do not fix the track in solid concrete. Also, do not use "rail clamps" or other mechanical devices that rigidly connect the rails together.

Laying Track Indoors

The basics of indoor trackwork are simple. Put the track where you want it, and if you want it there permanently, fasten it down. However, the indoor environment still offers LGB modelers a vast array of challenges and opportunities:

Floor Layouts

Thousands and thousands of homes around the world have LGB layouts on the linoleum, on the carpet, and during the holidays, around the Christmas tree. The technique is simple: Just take the track out of the box and assemble it on the floor.

Two tips are important to remember. First, LGB locomotives and some LGB cars can produce a small amount of carbon dust. It comes from the electrical pick-up brushes that rub against the wheels. For that reason, do not operate your train on white or very light-colored carpet. The carbon dust could stain the carpet.

Second, when you build your floor layout, use 11500 Track Clips to join the track sections. The clips will prevent the track sections from pulling apart, especially on slippery surfaces like hard floors.

The clips fit into the small slots molded in the end ties of most LGB track sections. The double tips on the clips can be used to compensate for length differences. Install the clips with the number molded into the clip facing down, and do not place excessive tension on the clips.

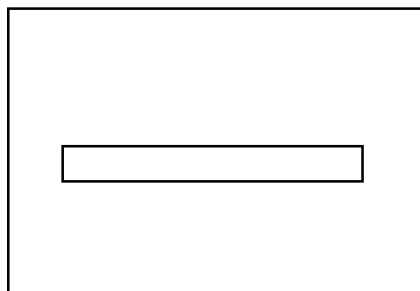

Traditional Layouts

Indoor LGB layouts can be built just like smaller scale model railroad layouts...only bigger. You can use the same traditional techniques for building benchwork with wooden frames and plywood roadbed. You can use the same traditional techniques for creating scenery with plaster mountains and acrylic rivers. You can use the same traditional techniques for making structures with sheet plastic and basswood.

Some of the world's great LGB layouts have been built using these very traditional, but very effective, techniques, and a large number of books have been written on these subjects. For more information, visit your local LGB retailer.

Doug Wead's "Andelle" layout uses traditional techniques for maximum realism.



Shelf Layouts

Perhaps LGB owners have more pride in their trains than other model railroaders. That could explain why so many LGB owners have shelf layouts in their homes. Instead of hiding their trains in an attic or basement, they put their trains in their living rooms and kitchens, using wall-mounted shelves as a roadbed.

These layouts are rarely realistic. After all, it is difficult to build a river or mountain or freight yard on a shelf that is only 150 mm (6 in) wide. However, these layouts are very appealing. Of course, they allow you to show off your LGB trains to your friends. Also, with a shelf layout, you and your family can run your trains in a comfortable setting at any time.

There are several manufacturers of pre-fabricated shelf layout systems. You can purchase the pieces that fit your room and install them yourself. You can also employ a local woodworking specialist to make the shelves. Or you can make the shelves yourself.



This shelf layout is integrated with the architectural design of the Givler family home. The speed control is concealed inside a rolltop desk.



Before building your shelf layout, consider these questions:

- Which radius curved sections (R1, R2 or R3) are you using? The corner shelves must be wide enough to fit the radius of the curved sections. Make sure the curved sections fit the shelves before you install the shelves, and make sure you have enough clearance for all your LGB locomotives and cars.

- How will you wire the layout? Standard color-coded, round-wire cable may be unattractive in this application. Instead, you can use flat cable designed for speaker installation. Some of these cables are self-adhesive and can be painted the color of your walls. Make sure to get the correct wire gauge for your power supply:

- maximum amp output 2 amps or less: 0.5 mm² wire cross section (20 AWG)

- maximum amp output more than 2 amps: 1.5 mm² wire cross section (14 AWG)

- Will the shelf layout be in an earthquake prone area or public area—where children of all ages can occasionally create earthquakes? If so, the shelf should have a guard rail to prevent the trains from falling.

Big Train Building Blocks: Modular Layouts

Think about building blocks, the little plastic bricks made for children. The blocks are different colors. The blocks have different shapes. But all the blocks are engineered to fit together. So the blocks can be combined to build bigger things, like castles and cars and spaceships.

Now, imagine a model railroad made with building blocks, except the building blocks are called "modules." The modules are decorated differently. One person might build a coal mine on a module, another might craft a forest. The modules are shaped differently. One person could make a straight section, another might make a corner.

But all the modules from all the different people are engineered to fit together. The tracks are always at the same positions on the edge of each module. The electrical connections are always coded with the same colors. Modules of the same shape always have the same height, width and depth. So the modules can be combined to build bigger layouts, from simple ovals to gigantic displays.

The concept of modular model railroading came to G scale from the smaller scales, but the idea has been eagerly adopted by LGB fans around the world. If you don't have the space, time or inclination to build a big garden railway with 100 meters of track, you can still enjoy detailing a module with one meter of track. Plus, modular model railroading, by its

nature, is a group activity. If you want to have fun with lots of people, try modular railroading.

The most famous G-scale modular railroad in the world is Del Oro Pacific Modular Railroad, based in the Los Angeles, California area. The railroad has more than 50 members, and that group has assembled its amazingly detailed modules at dozens of fairs, shows and conventions in the western United States. At a single gathering, the group has assembled layouts consisting of more than 100 modules.

Unfortunately, there are no

universally accepted module standards. Instead, the standards are usually established regionally, by local groups of module builders. Information on the Del Oro Pacific is available from:

Del Oro Pacific Modular Railroad
225 18th St.
Huntington Beach, CA 92648
USA

In Europe, standards have been established by various groups, including IG Spur II. For more information, contact:

IG Spur II
c/o Ralf Muehlbichler
E-mail: rmuebi@T-ONLINE.DE



The Del Oro Pacific Modular Railroad winds through a convention center in Pasadena, California.

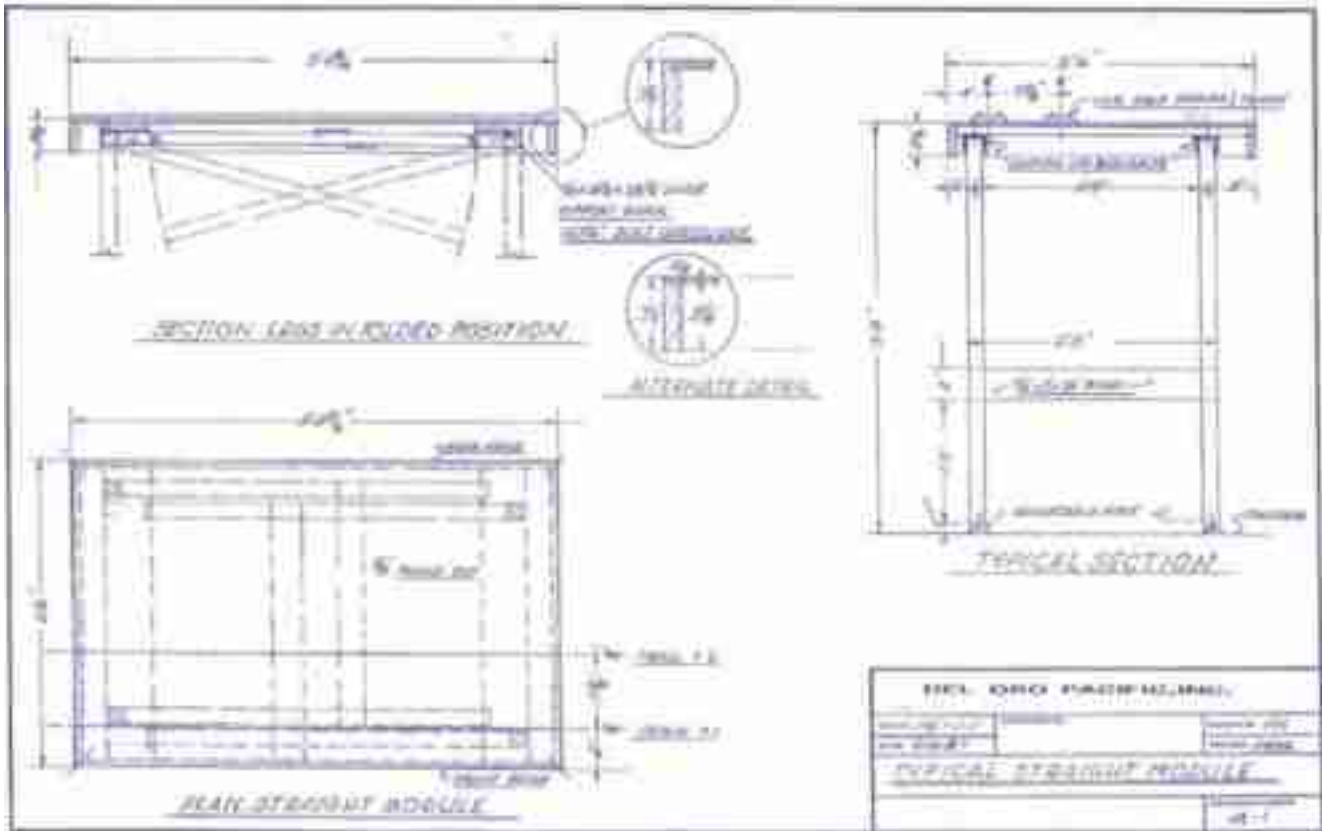

These blueprints illustrate the standards for the Del Oro Pacific Modular Railroad. The blueprint above defines the height, width, depth and track spacing of "straight" modules. The blueprint below demonstrates how straight, curved and transition modules can be used together.

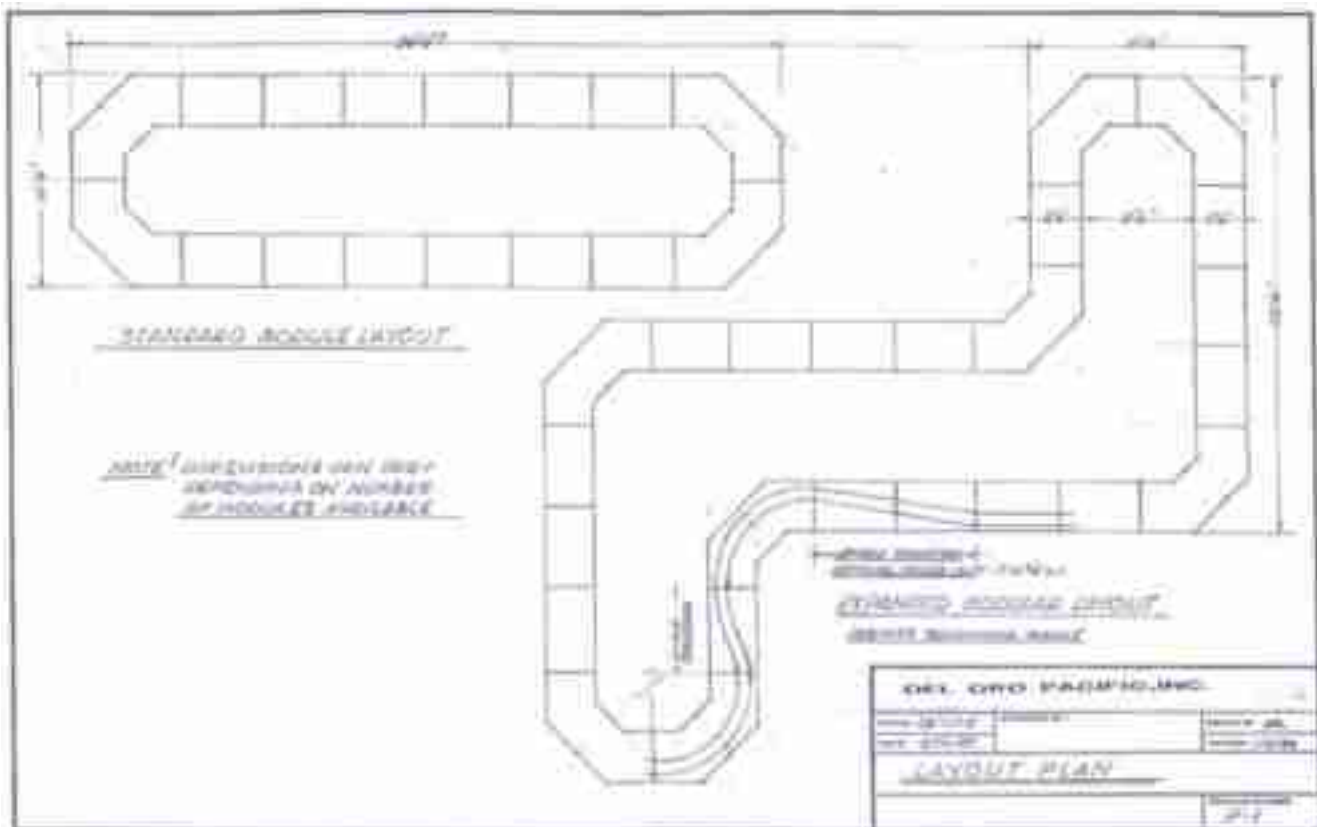

Special Layout Features

This book is deceptive, just like all track planning books. Track planning books are printed on paper. They can only show you layouts in two dimensions. Everything is flat. Everything is even. In real life, real railroads go up and down, through hills and valleys, across streams and highways. Here are some special layout features that will help you bring your two-dimensional layout to life.

Grades

From a technical standpoint, grades are merely inclined sections of track. From an artistic standpoint, grades are a critical element in good layout design because they add a third dimension, height, to a flat layout. Grades also allow you to overcome natural obstacles without excessive excavation, and grades let you create artificial obstacles that add visual appeal.

But grades must be designed and built with care. Excessive and irregular grades will cause poor operation, like inconsistent speeds and unplanned uncoupling, ruining the visual effect you worked so hard to achieve. (In fact, real railroads avoid grades as much as possible by using cuts, fills, bridges, trestles and tunnels. These features are usually more interesting to model than grades and are much easier on your trains.)

• **Measuring grades.** In model railroading, grades are measured as percentages (%). The formula for calculating the percentage is simple:

$$S = (H/L) \times 100$$

- S is the grade in percent.
- H is the change in height between the bottom and top of the grade.
- L is the length of the grade.

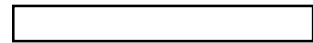
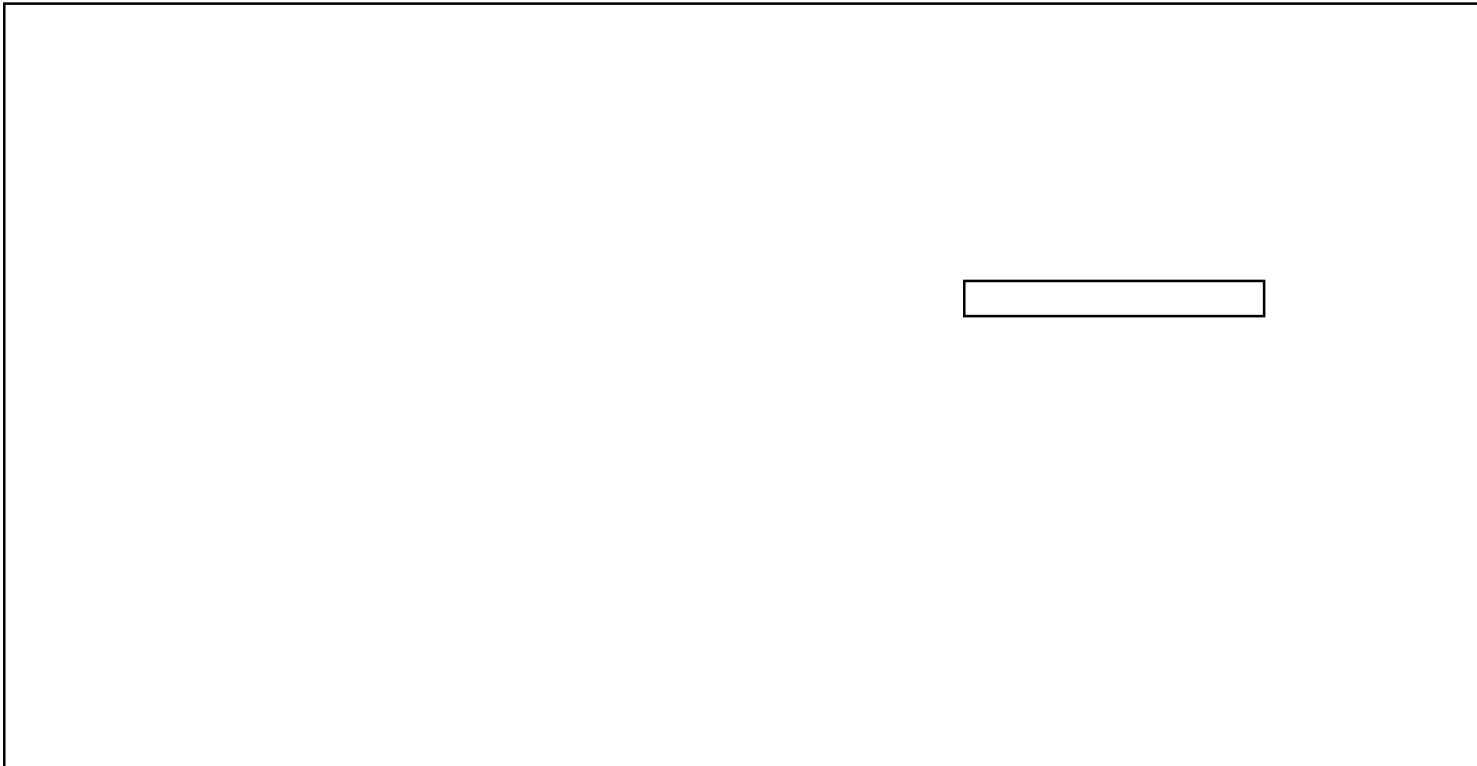
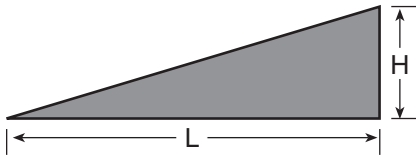

For example, say the length of your grade is 4000 mm. Over that length, the change in height is 80 mm. How steep will the grade be?

$$S = (80/4000) \times 100$$

$$S = (0.02) \times 100$$

$$S = 2\%$$

You can measure the length of your grade directly, or you can calculate the length by adding the lengths of the track sections. This chart shows the running length of the most common track sections:

Number	Type	L = mm (in)
10000	Straight	300 (11.8)
10600	Straight	600 (23.6)
11000	R1, 30°	313 (12.3)
15000	R2, 30°	407 (16.0)
16000	R3, 22.5°	470 (18.5)

You can measure the height of your grade using a long "carpenter's level" and a ruler. You can use any measure—millimeters, inches, miles, etc.—as long as you use the same measure for both H and L.

• **Recommended grades.** On real railroads, you will rarely find a grade greater than 2%, but on LGB railroads, grades up to 4% are acceptable.

However, a grade that is acceptable is not always desirable. A grade of just 1% will noticeably reduce the number of cars a locomotive can pull up the track.

Also, pulling power is reduced by curves, because of the increased friction between the wheels and the curved rails. So curved grades should

This layout uses a street car line (blue) to traverse the steep grade between the upper (green) and lower (yellow) line.



be designed with less incline than straight grades. Use these guidelines for LGB curved sections:

Radius	Maximum Grade
R1	2.00%
R2	2.25%
R3	2.50%

• **Improving pulling power.** If you cannot avoid a grade, there are things you can do to increase the number of cars that can be pulled up the grade:

- Keep the track clean by using an LGB track cleaning device, like the 50040 Track Cleaning Block. (See Chapter 15 for more information.)
- Keep the wheels clean with 50010 Smoke and Cleaning Fluid.
- Replace the car wheels with low-friction 67403 Ball Bearing Wheel Sets. This is especially important if you have cars with conventional metal wheels and electrical pick-up brushes.

• Use a locomotive with very good pulling characteristics. For example, the 2025-series locomotives and the 2043-series locomotives are well known for the ability to handle heavy loads on grades and curves.

• Use extra locomotives on grades. Just as real railroads use "double headed" trains in the mountains, you can use two or more locos to tow a train up a steep grade.

Attention! Different LGB locomotives may operate at different speeds even with the same track voltage or speed control setting. If two or more locos are connected together, this speed difference may cause damage to the gearboxes of the locomotives. If you "double head" locos in this fashion, use identical locos or make sure the locos operate at the same speed.

• **Eliminating pulling problems.** You can eliminate the problem of pulling cars up a grade by not pulling any cars up the grade. Real railroads operate a variety of self-propelled vehicles that do not normally pull cars, and there are several models of these in the big LGB program, including the 20680 Aha® Rail Truck and 21355 Weimar Streetcar Set

These types of vehicles can easily be integrated into any layout. For example, the urban layout on Page 71 features a steep streetcar line that rises quickly from the station on the lower level to a platform on the upper level. Flex track was used to create the very tight curve, which has a radius of just 400 mm (15.7 in).

The streetcar line is a "point-to-point" layout. There is no way to turn the train around when it reaches the end of the line. However, that's not a problem for double-ended vehicles, like streetcars, which operate just as well in reverse as forward. The entire operation can be automated using an 80090 Automatic Reversing Unit. It continuously runs the vehicle from one end of the layout to the other, pausing for an adjustable time at each end.

• **Grade building tips.** It is very important to construct smooth grades. Kinks and other irregularities can cause unintentional uncoupling and loss of traction.

At the entrance and exit, the incline should gradually increase and decrease. If necessary, use short track sections to create a flexible vertical transition or gently bend the track rails to the proper shape.

In the middle, the incline should be constant. Sharp dips or bumps can easily increase the grade percentage beyond acceptable levels.



Self-propelled models, like the Aha® Rail Truck, are well suited to steep grades.



The big 50610 bridge (above) can be used with or without LGB piers (below).

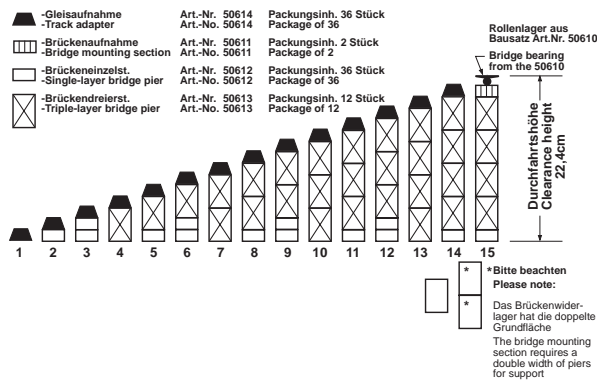

Building Bridges

Bridges are a valuable tool for LGB layout builders. With them, you can cross over rivers, valleys, streets and railroad yards. Many makers offer G-scale bridges in a wide variety of styles and sizes. The LGB bridge program includes two bridges:

- 50600 Truss Bridge, 450 mm. This classic span is a replica of a Warren truss bridge. The deck is sized to fit LGB straight track sections. This one-piece bridge is 450 mm (17.7 in) long and has mounting holes on each end. Like LGB trains, this bridge is UV-resistant and weather-resistant
- 50610 Steel Bridge, 1200 mm. This huge model comes in simple kit form. A screwdriver is required to assemble the bridge. The finished bridge is 1200 mm (47.2 in) long and 300 mm high with an inside clearance of 224 mm. The bridge can be used to span up to six LGB track sections, and overhead catenary wiring can be installed inside the bridge. This bridge is also UV-resistant and weather-resistant.

The 50610 can be used independently or with LGB bridge piers:

- 50611 Bridge Mounting Pier, 2 pack
- 50612 Single-Layer Pier, 36 pack
- 50613 Triple-Layer Pier, 12 pack
- 50614 Track Mounting Pier, 36 pack

These piers can be used in both permanent and temporary layouts to create a variety of grades to the 50610 bridge. For example, the piers can be combined, as shown here, with fifteen 10000 straight track sections to create a 5% ramp to a 50610 bridge located 224 mm (8.8 in) above ground level.

Tunneling Through

Tunnels are a favorite feature on LGB railroads. Tunnels make your trains disappear, and by doing that, they create the visual illusion that your trains are going somewhere far away.

Unfortunately, tunnels can be a major maintenance problem, especially on outdoor layouts. Track is difficult to clean inside tunnels. Leaves collect inside tunnels. Squirrels take shelter inside tunnels. Bees build nests inside tunnels. Trains wreck inside tunnels.

You can reduce, if not eliminate, tunnel maintenance problems by following these three steps:

- Make it short. Do not make the tunnel longer than you can easily reach. If the tunnel must be longer, include an access panel so you can reach the trains that will, inevitably, derail in the center of the tunnel.
- Make it straight. Use straight track sections instead of curved sections. This reduces the possibility of derailments and eliminates the problem of interference with overhanging locomotives and rolling stock.
- Make it simple. Use longer track sections to reduce the number of rail joints. Do not install switches or crossings inside a tunnel. Avoid grades inside tunnels.

When building bridges and tunnels, check for clearance information included with some larger LGB models, like this caboose model.

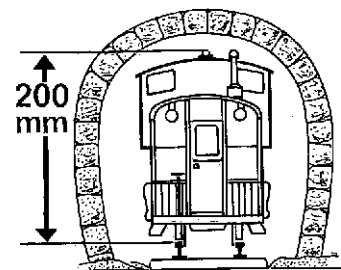
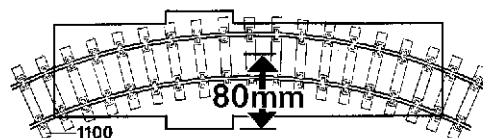

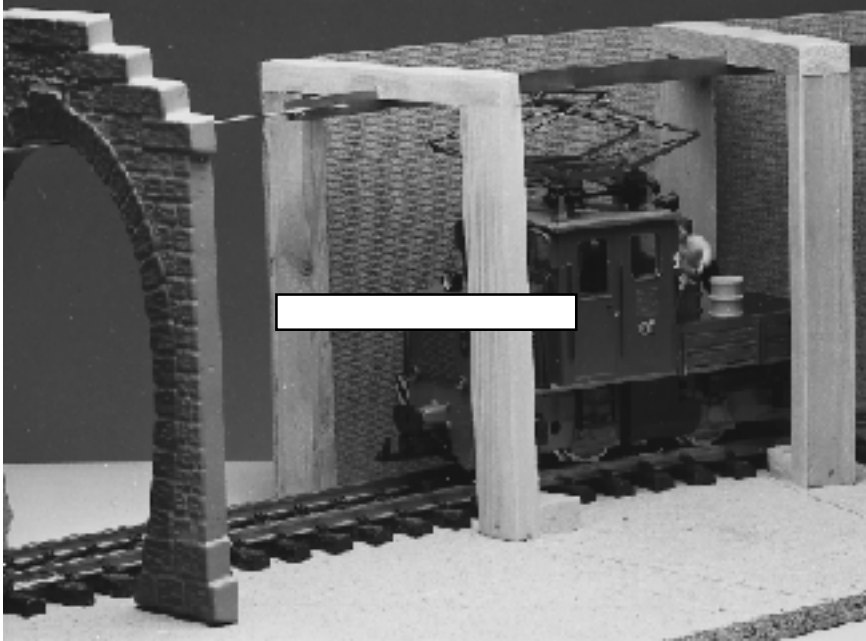

Catenary in Tunnels

Mountain railways, like the spectacular Rhätische Bahn, often have both tunnels and overhead catenary wiring. LGB's overhead catenary systems are not made for use inside tunnels, but you can solve that problem easily.

Just install a brass strip in the roof of the tunnel. Cut a groove in the tunnel frame to hold the strip. Taper the ends of the strip to make the transition to an LGB catenary wire attached to the strip with a screw.



Rack Railroading

The ultimate solution to grade problems is a rack railway. Regular LGB trains, like most real trains, use the "adhesion" between the wheels and rails for traction. However, rack railways (sometimes called "cog" railways) can exceed the limits of adhesion, climbing grades as steep as 48%. Rack locomotives are equipped with a large drive gear, called a "cog." That gear meshes with a "rack" mounted on the ground between the rails.

Rack railways can be found in mountainous areas around the world, for example:

- Furka Oberalp Bahn in Göschenen, Switzerland
- Manitou & Pike's Peak Railway in Colorado, USA
- Mt. Washington Cog Railway in New Hampshire, USA
- Pilatusbahn in Alpnachstad, Switzerland
- Snowdon Mountain Railway in Snowdon, Great Britain
- Bayerische Zugspitzbahn in Garmish, Germany

The LGB rack railway system is modeled after the "Abt" prototype system, which is used by the Furka Oberalp Bahn (FO) and many other



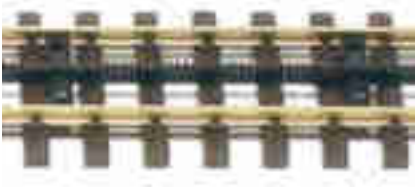

Use 10220 Cog Rack Holders to secure the 10210 Cog Rack between the rails.

rack railways. LGB rack locomotives can operate on grades of up to 25%, climbing 250 mm for every 1000 mm of horizontal distance.

The LGB rack program includes rack locomotives along with some special rack accessories:

- 10210 Cog Rack, 300 mm, 12 pack
- 10220 Cog Rack Holder, 24 pack
- 64462 Rack Loco Coupler Hooks, 8 pack

The 10210 Cog Racks (or "rack rails") are easy to install. Using the 10220 holders, they can be fitted into both straight and curved LGB track sections, and the rack sections can be installed in existing layouts without removing the track.

To install a cog rack, install the holders between the track ties. The distance between the holders will vary, but in curves, the distance between holders should be less than 150 mm (5.9 in).

Once the holders are in place, snap the racks into the holders from above. The holders will latch to the rack and to the track.

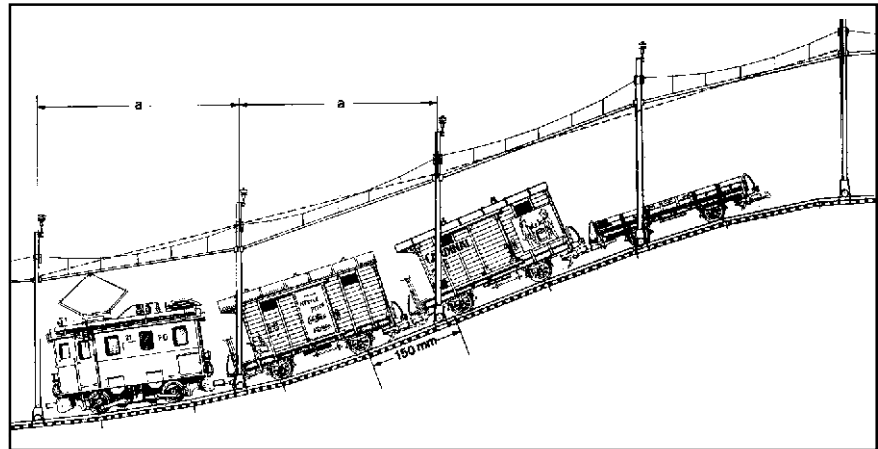

Rack Railway Tips

- To avoid abrupt transitions, use several short straight track sections, like 10150 sections, at the beginning and the end of a steep section. Slightly bend each joint vertically to create a smooth transition.

- For overhead catenary operation on steep sections, use the 56300 tilting catenary mast. The masts should be spaced closer than on level track.

- To avoid accidental uncoupling, 64462 coupler hooks are recommended for rolling stock used on rack sections. Also, "symmetrical" coupler hooks should be installed on both ends of all rolling stock.

- LGB rack locos can be used on rack sections and regular "adhesion" sections.

Attention! When climbing or descending a steep section, the rack loco should always be on the downhill side of the train. Real rack railways follow this safety procedure, and LGB rack operators should abide by the same rule.

Clearance

For trouble-free operation, you must have adequate clearances between your trains and layout structures, like signals, tunnel portals and bridge piers. However, the required clearances vary tremendously depending on the trains and on the track configuration. Here are some hints:

- On straight track sections, you need at least 60 mm (2.4 in) of horizontal clearance, measured from the center of the track to objects (including other trains) alongside the track.
- On curved track sections, you need additional horizontal clearance, especially on the inside of the curve. The required amount of clearance depends on the curve radius and on the locomotives and cars used on the curve. Long cars used on tight curves will require the most clearance. For example, if you use a 42750 Usego Sliding Wall Car on an R1 curve, you will need at least 95 mm (3.7 in) clearance on the inside of the curve.
- Most LGB locos and cars require less than 203 mm (8.0 in) of vertical clearance, measured from the top of the rail.
- If you have an overhead wiring system, the overhead "catenary" wire should be 208 mm to 232 mm (8.2-9.1 in) above the top of the rail.
- Some trains may have different clearance requirements. Always check individual locomotives and rolling stock on your layout for adequate clearance.

Check for clearance information included with some larger LGB models, like this caboose model.

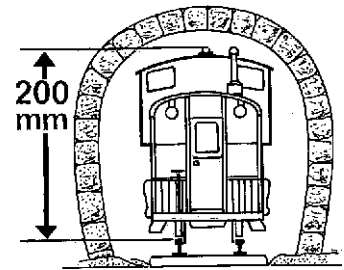
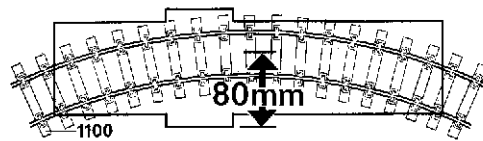

The 10310 bumper can be installed on the end of most LGB track sections.

Track Bumpers

Track bumpers are used to prevent trains from accidentally running off the end of the track. The LGB program includes two track bumpers:

- 10310 European Track Bumper with Light. This bumper (shown here) can be attached to the end of most LGB track sections. Special clips are molded on the bottom of the bumper. To install the bumper, just press the clips on the track. This bumper also includes an 18 volt signal light. The light is helpful for indicating whether or not there is power in that particular section of track.

Hint: This bumper, without the light, is included in the 19901 Siding Track Set. The light (50520) can be purchased separately.

- 10320 American Track Bumper. This bumper is built into a 300 mm straight track section.

Also, 10250 Wheel Blocks can be used as temporary, very low speed bumpers.



LGB Q&A

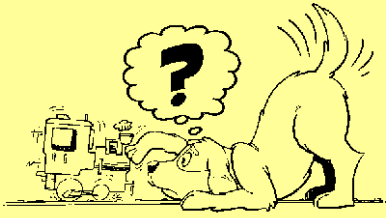

Q&A: How should I join the rails?

Heinz Koopmann, chief technical consultant to E.P. Lehmann Patentwerk, explains...

LGB trains run on electricity. In most cases, that electricity is transmitted to the train through the rails in the track. So if there are bad connections between the rails, the electricity will not be transmitted...and the train will stop. It is not fun when the train stops. You have to apologize to your visitors, climb across your layout, apologize to your spouse for stepping on the plants and push the train to make it start again.

On outdoor layouts, the problem is often caused by a bad connection at a rail joiner, the brass shoe that holds the rails together. Dirt and water enter the joiner. The metal inside the joiner oxidizes, and the electrical connection between the rails is weakened or destroyed. How can you prevent this problem?

Some people use mechanical devices to rigidly clamp the rails together. However, these “rail clamps” are expensive, and they prevent the natural and necessary movement of the rails with expansion and contraction. Soldering jumper wires to the rails is possible, but difficult.

Another solution is far less expensive and far less difficult: LGB 51010 Graphite Lubricant. Just put a small amount—the size of a pea—in each rail joiner when you assemble the track.

How does this help rail joiners? One of the materials in 51010 is graphite. Graphite is a low-resistance material, but as long as the graphite is in suspension within microscopic balls of grease, there is no electrical effect. However, when 51010 is placed under pressure, like between the rail and rail joiner, the situation changes. The balls of grease are crushed, leaving the graphite in direct contact with the rail and the rail joiner. Now current can flow from the rail to the rail joiner via the graphite.

This lubricant also has a low evaporation rate and good resistance to moisture and oxidation. So it stays in the joiner after you put it there, even outdoors. That prevents oxygen from entering the joiner, and so, there is no chance for the brass to corrode.

Does it really work? In 1986, I built a 150-meter test track with separate zones for testing different track connection methods. Ten years later, I still have not had a single electrical problem in the 51010 zone. I have disassembled several track sections in that zone, and the rail joiners still look like new inside.

Finally, an expert tip: It is best to fill every tiny space between the rail and rail joiner with 51010. Use physics to help you. Gently heat the rail and the rail joiner with a soldering iron until the 51010 turns into a liquid. Then it will creep into the tiny spaces between the two. When it cools down, the 51010 will change back into a grease.



Just a dab of 51010 Graphite Lubricant will prevent problems with rail joiners.

LGB Q&A

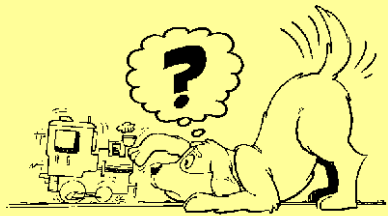

Q&A: What is flex track?

Flex track is...well, flexible track. It can be cut and bent to fit your needs, and that makes it perfect for solving all kinds of layout problems. For example, in this layout, we used flex track (shown in red) to connect an arc of 11000 curved sections with an arc of 15000 curved sections. The flex

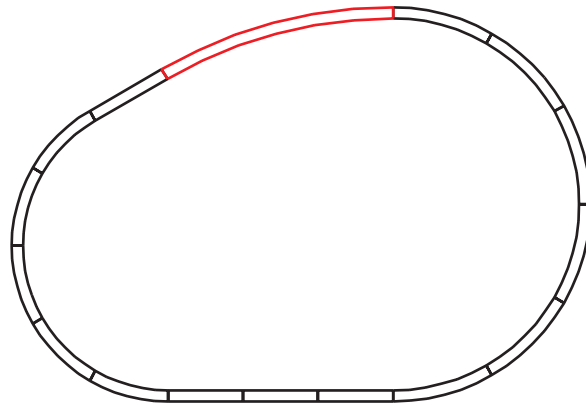

track made a smooth, seamless curve without the irregularities of sectional track. Flex track also allows you to make very wide-radius curves for very graceful operation of very long trains.

The LGB program includes flex track; however, it is not sold as one item. Instead, you need to purchase three separate items:

- 10001 Metal Rail Joiner, 10 pieces
- 10003 Tie Section, 300 mm, 50 pieces
- 10005 Rail Section, 1.5 m, 20 pieces

For example, if you wanted to make a 1.5 meter (1500 mm) straight section, you would use five 300 mm tie sections, two 1.5 m rail sections and two rail joiners. The rails simply slide into the ties. The joiners slide onto the ends of the rails.

What if you want a shorter section? Cut the ties and rails to fit. The ties can be cut with a sharp hobby knife. However, the rails are very hard brass, and it is important to make a smooth cut. Use a fine toothed razor saw or a rotary cutting tool, like a Dremel™ or Microcraft™ tool. Clean the cut with a fine-toothed file.

What if you want a curved section? Many people use a "belly bender." That is, they take the rail and bend it around their waist. That works surprisingly well for larger radius curves. However, for more precise curves, we recommend using a rail bending tool. Quality rail bending tools are available from companies like Istra Metalcraft and L&L Screw Machine Products. Ask for a bending tool made for LGB "Code 332" rail.

Lang Garden Bahn: Ready to Go

Finally, the Langs have a plan for their first permanent garden railway. Paul and Heidi have decided to build it in the corner of the yard, using a hedge as a background. For simplicity and continuous operation, the Langs chose a basic "dogbone" oval with a few special features.

First, all of the curved track sections are R2 medium-radius curves. The only sharp curves are in the 12000-series switches, and all of those switches are near the outside of the layout for easy maintenance. The passing siding at the station includes two stub sidings, one short stub for locomotive maintenance and storage and one long stub for freight car loading.

All four station switches are electric. They will be controlled using one 51750 Momentary Control Box with an 52750 EPL Booster. The 52750 will increase the reliability of the EPL switch drives, especially in demanding outdoor conditions.

What about the fifth switch, located on the far upper end of the layout? For now, a manual switch will be installed there since that siding only serves a small factory. In the future, that siding could be used to extend the layout along the hedge to the other corner of the yard.

Layout 1

37	10000
2	10040
1	10050
2	12000
3	12100
24	15000

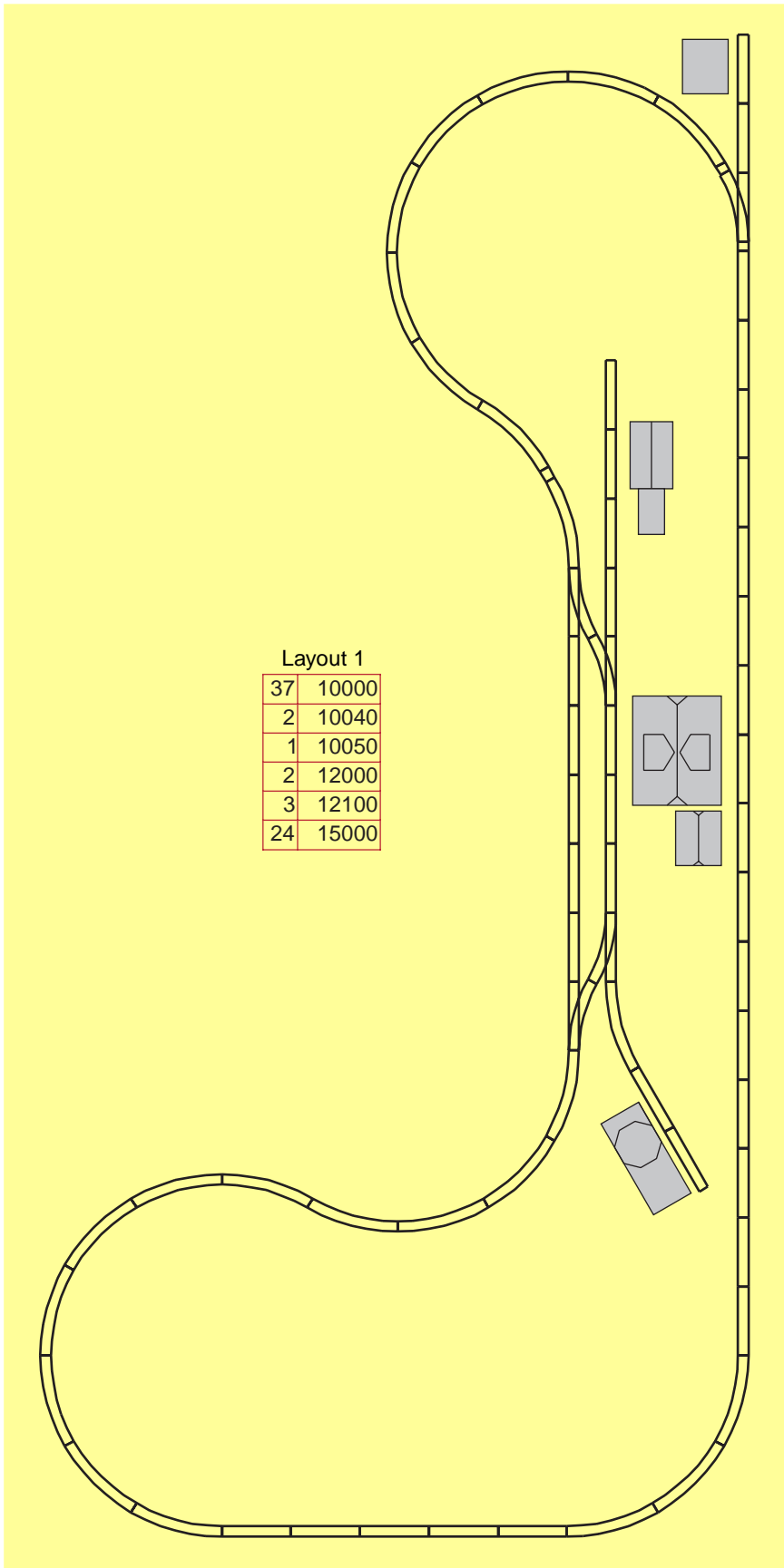

Discoveries: Layout Building for the Intimidated

Story and Photos by Rod Johnston

I think the toughest part of building a garden railway is just getting started. Initially, most of us set some track on the grass and run our LGB trains on it.

But after reading some garden railway magazines or perhaps watching a video showing beautiful layouts with hills, tunnels and trestles, or seeing a fellow club member's efforts, we yearn to do the same thing.

Keep It Simple!

I have discovered that you don't have to be a draftsman...or even know what you're doing! You may not even know where your outdoor layout is going to develop. Don't be intimidated—let me show you how to do a seat-of-the-pants layout plan!

First, buy a bunch of LGB track. I suggest that you not buy curves smaller than LGB's 15000 curved track unless your space is limited. You'll find you never have enough track, so don't worry about buying too much. (Remember, if you decide you do have too much track, there are plenty of us eagerly searching for used track!)

Now, find the area you want to develop and get some scrap wood boards—just about anything will do, as long as it will support the track over open areas. Lay out the track, unconnected, wherever you think it looks best. This method gives you some idea of what the finished version will look like, and the obvious obstacles will show themselves.

Next, lay out the boards, supported with upright stakes with the pointed ends driven into the ground. If the ground is too hard, pile up rocks along the boards to keep them upright and fairly level.

For curves, use short boards laid out one at a time. Support the wood with stakes or rocks, and lay the curved track on it. Attach the next piece of track to see approximately where it goes, and lay the next short piece of wood under it. Repeat this process until you're back on the straight track.

The openings between the boards can be quite large, as the track can temporarily span spaces of about 300 mm (1 ft) without support. If there is a steep incline you would like to try, just place a long board on the incline and lay the track on top. Wherever you need a bridge, just lay a board across!

And...Voilà!

In a couple of hours, you should have your temporary, somewhat wobbly, layout set up. Now, you can take your least loved, least expensive, or most cumbersome engine and cars and run them around the track. This is the time to try pulling lots of cars up the steep parts. If you're working around existing landscaping, this is the time to see if the tracks are too close. You'll discover all sorts of unknowns.



Just lay out the track wherever you think it looks best. Over gaps, support the track with whatever wood you have.



Here's Rod's bridge, several months later, complete with trestles and landscaping.

Are your bridges high enough for trains to pass under? Are your tunnel areas wide enough? Are the grades too steep for anything but a rack locomotive? If the train falls off the tracks or crashes into something, not to worry—these trains are tough. And remember, this is research! Besides, you get to run your trains outdoors without doing a lot of work.

When I did my initial layout, my plan was to run my LGB Frank S. live steam loco. I had visions of a true narrow gauge line with lots of hills and valleys. The track looked good going up and down and around, but when I ran the train I discovered that downhill, it had a desire to fly...especially when it came to the curves. Uphill, it just stopped and hissed. So, I learned that the track should be very close to level. I adjusted the support stakes until the Frank S. ran smoothly. I then had the basis for my layout as I built up the dirt to the level of the boards, took away the boards and set the track back into its new ballast material.

Why You Should Try This

Some of the advantages of the seat-of-the-pants planning system are...

- it can easily be taken apart and changed
- your spouse can take a look at what you have been babbling about and decide if there is any hope
- others can look at the basic set-up and understand what you want to do...and offer suggestions
- you can finish parts of your layout at a time and still be able to run trains
- you can better plan for the new accessories you'll read about and better visualize layout expansion ideas

Plus, when friends come by, you can describe how that old concrete-covered board will eventually be a beautiful truss bridge with brass rod supports, and how the splintered uprights will soon be a lovely trestle. With your rough layout before them, they might actually be impressed!

And if you think this is something new, consider that the very early real railroads were built this way. They made very rough trestles across low and swampy areas, placed track on top, and ran trains with gondolas full of sand across the trestles. The sand was dumped over the trestles until they were covered and the track was supported by a solid embankment. Because everything was done by hand in the late 1800's, there was no quicker way of filling in those low areas, and it was important to get those trains running so they would pay for themselves.

Making a railbed through your garden poses some of the same problems in miniature. It's a great way to appreciate the problems encountered making the dream a reality. It is, however, much easier to do than you think—so, get out and get started!



CHAPTER 7: MORE POWER

The LGB power supplies and controls can be used together to handle any size layout.

Most of the time, electricity is easy. Press a switch, and the light goes on. Turn a knob, and the stove gets hot. The washing machine washes your clothes, and the refrigerator keeps your food cool. You can get electricity almost anywhere by plugging into an outlet. You don't have to think twice about it.

But now you've decided to buy an LGB train. Will you have to solve complex electrical problems? Don't worry. With LGB, electricity is still easy.

A Few Words

Sometimes, electrical concepts seem confusing, but often, the problem is that people use different words to describe the same things and the same words to describe different things. For simplicity, we use these terms:

- **House current.** This is the electricity that comes from the outlets in your home. It may be 110 volts, 230 volts or some other high voltage, depending on where you live.

- **DC.** This is the electricity you use to operate LGB trains on traditional LGB layouts. By varying the voltage and polarity (+/-) of the DC, you can control the speed and direction of the train. The maximum DC voltage for LGB trains is 24 volts.



- **AC.** This is electricity you use to operate LGB accessories, like switch drives and lamps. The AC voltage for LGB accessories is usually 18 volts.

- **Digital-AC.** This is the electricity you use to operate LGB trains on Multi-Train System layouts. This is a special form of AC with digital signals to control the "decoders" in Multi-Train System locomotives. (See **Chapter 8** for more information.)

Hint: On LGB products, DC connections are usually marked with a locomotive symbol, a double-line symbol or the numbers "1" and "2" (see chart below).

AC connections are usually marked with a symbol that looks like a light bulb, a wavy-line symbol or the numbers "3" and "4".

Specific markings vary from product to product. Read the instructions that come with each product for more detailed information.

Current Type	Current Symbol	LGB Terminal Number	LGB Terminal Color
DC		1 2	Red Blue
AC		3 4	Black White

Power Supply Devices

In the World of LGB, there are three basic types of power supply devices:

- **Transformers.** A transformer converts house current to a low, fixed voltage (AC, DC or both, depending on the transformer). Because they are connected to house current, transformers must be kept indoors or in weather-protected enclosures.
- **Speed Controls.** A speed control does not produce electricity. Instead, it varies the voltage from the transformer so you can change the speed of your train. Most LGB speed controls also have a built-in direction control that changes the polarity. Speed controls are sometimes called "throttles."
- **Power Packs.** A power pack is a transformer and speed control combined in a single housing. Because they are connected to house current, power packs must be kept indoors or in weather-protected enclosures.

The LGB Power Program

The LGB power program includes a variety of transformers, speed controls, power packs and accessories, and **the program is always being expanded with new products to meet new needs.** For updated information, visit your local LGB retailer. Currently, the LGB power program includes:



Transformers

Model	House Current	AC Output Voltage	DC Output Voltage	Output Amps
50060	230 V	18 V	24 V	2.0 A
50061	110 V	18 V	21 V	1.5 A

These versatile transformers can be used to power trains (DC) or accessories (AC) or both. If used to power trains, they must be used with a separate speed control, like a 50070 Electronic Throttle.

Hint: The output amps for these transformers represent the combined AC and DC output. If you use these transformers to power AC accessories, the amperage available for powering DC trains will be reduced.



Model	House Current	AC Output Voltage	DC Output Voltage	Output Amps
50110	230 V	18 V	none	5.0 A
50111	110 V	18 V	none	5.0 A

These AC-only transformers are primarily intended for use with the LGB Multi-Train System. (See **Chapter 8** for more information.) However, they are perfect for powering large numbers of accessories.



Model	House Current	AC Output Voltage	DC Output Voltage	Output Amps
51080	230 V	18 V	none	0.5 A
51081	110 V	18 V	none	0.5 A

These AC-only transformers can be used to power accessories, like switches, signals, electrical uncouplers and lights. They can also be used to power the 90013 Lehmann Rigi Duo[®] Cableway.



Speed Controls

Model	DC Input Voltage	DC Output Voltage	Output Amps
-------	------------------	-------------------	-------------

50070	0-24 V	0-24 V	2.0 A
-------	--------	--------	-------

This speed control is made for use with the 50060 and 50061 transformers. Designed for indoor use, it uses the same style housing as those transformers. It has a combined speed/direction control knob plus emergency stop and maximum voltage buttons.

Like all speed controls, this speed control cannot output more than it is input. If the input is 18 volts, the output can be no more than 18 volts.



Model	DC Input Voltage	DC Output Voltage	Output Amps
-------	------------------	-------------------	-------------

51120	0-24 V	0-24 V	2.0 A
-------	--------	--------	-------

This speed control is also made for use with the 50060 and 50061 transformers. However, it is equipped with an attractive "Signalman's Hut" housing and can be used outdoors without any additional protection. It has a combined speed/direction control knob with maximum voltage positions on both ends of the control range.

Like all speed controls, this device cannot output more than it is input.



Model	DC Input Voltage	DC Output Voltage	Output Amps
-------	------------------	-------------------	-------------

50121	0-24 V	0-24 V	2.0 A
-------	--------	--------	-------

This speed control is similar in operation to the 51120, but it is designed for custom installation in switch boards and control panels. Also, the maximum amp output is 2.0 amps.

Like all speed controls, this device cannot output more than it is input.



Power Packs

Model	House Current	AC Output Voltage	DC Output Voltage	Output Amps
-------	---------------	-------------------	-------------------	-------------

50080	230 V	none	0-20 V	1.0 A
-------	-------	------	--------	-------

50081	110 V	none	0-20 V	1.0 A
-------	-------	------	--------	-------

This compact power pack—a transformer with built-in speed control—is perfect for powering small layouts and electrically isolated track blocks.



Model	House Current	AC Output Voltage	DC Output Voltage	Output Amps
-------	---------------	-------------------	-------------------	-------------

50100	230 V	none	0-24 V	10.0 A
-------	-------	------	--------	--------

50101	110 V	none	0-24 V	10.0 A
-------	-------	------	--------	--------

The "Jumbo" is an extremely powerful and versatile power pack. Details on the Jumbo and the Jumbo remote control can be found on Page 87.



Wiring Accessories

Wire

Model	Color	Gauge	Length
50130	Orange/White	0.5 mm ² (20 AWG)	20 m
50140	Black/White	0.5 mm ² (20 AWG)	20 m

50130 is a two-wire cable. Each wire is color coded for wiring EPL devices, like 12010 EPL Switch Drives.

50140 is also a two-wire cable. Each wire is color coded for wiring AC accessories, like street lights.

Wire

Model	Color	Gauge	Length
50160	Blue/Red	0.5 mm ² (20 AWG)	1.5 m
51230	Blue/Red	1.5 mm ² (14 AWG)	15 m

These two-wire cables are color coded for track power connections.

50160 is equipped with two 50161 Track Power Terminals. It is similar to the cable included with most LGB starter sets.

51230 features heavier gauge wire for use with the Jumbo power pack. 51230 is also recommended for use with other power supplies when long wire runs are necessary.

Connectors

Model	Type	Pieces
50131	Wire Terminals	50
50161	Track Power Terminals	2

50131 Wire Terminals are used to prevent bare wire ends from fraying. They can be attached to most LGB wires with a wire crimping tool.

However, these terminals cannot be used with 51230 twin lead.

50161 Track Power Terminals are used to connect wires to LGB rails. Each terminal has a thumbscrew rail clamp and a wire connection lug.

Terminal Boxes

Model	Type
50720	Distribution Box
50730	Connection Box

The 50720 Distribution Box has two sets of twelve connected terminals. Terminals 1 to 12 are connected to each other, and terminals 13 to 24 are connected to each other. Typically, the 50720 is used to distribute power to various devices, for example, AC power to street lights and EPL devices.

The 50730 Connection Box has twelve sets of two connected terminals. It is typically used to make a transition, for example, between a control panel and a bundle of buried cables.

The Jumbo Power Pack: The Power of an Elephant

The advanced, all-purpose Jumbo power pack is the standard in model railroad power technology. No other large-scale power pack delivers this



The Jumbo power pack (right) and Jumbo remote control (above) are engineered for operating large layouts with multiple locomotives.



level of performance and ease of use while conforming to strict international safety regulations. With an output power of up to 24 volts and up to 10 amps, the Jumbo gives model railroaders enough power for large, complex layouts.

The Jumbo is engineered for:

- multiple locomotives
- large layouts
- multiple track segments
- long track segments with significant power loss
- advanced control functions

The Jumbo features:

- 10 amp power output
- variable acceleration
- variable deceleration
- maximum drive voltage control
- minimum drive voltage control
- delay timer (0-75 seconds)
- volt and amp meters
- touch keys with LED indicators
- remote triggering of touch keys for automatic train operation
- remote control (optional)
- adherence to strict international regulations

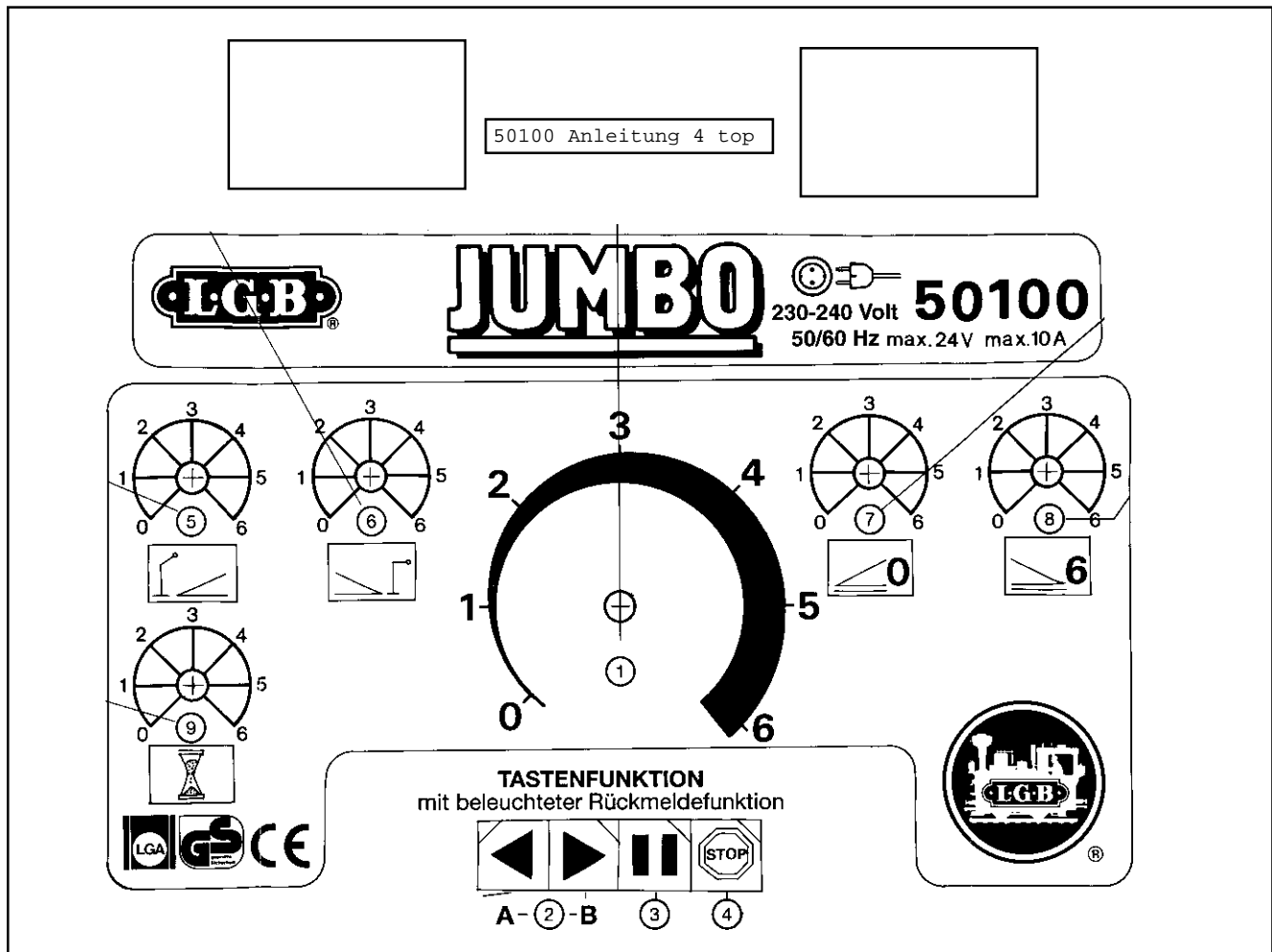

The Jumbo front panel includes:

- (1) Drive voltage control
- (2A) Forward key
- (2B) Reverse key
- (3) Brake key (with pre-set deceleration)
- (4) Emergency stop key (with no delay)
- (5) Acceleration rate control
- (6) Deceleration rate control
- (7) Minimum drive voltage control (sets the minimum output voltage at the "0" setting of the drive voltage control)
- (8) Maximum drive voltage control (sets the maximum output voltage at the "6" setting of the drive voltage control)
- (9) Delay Timer (0-75 seconds)

This timer is activated using one or more LGB 17100 track contacts or other switches. Once the timer has been started, it can be canceled before the timed period is finished by pressing a direction key.

- (10) Voltmeter 0-30 volts
- (11) Ammeter 0-10 amps

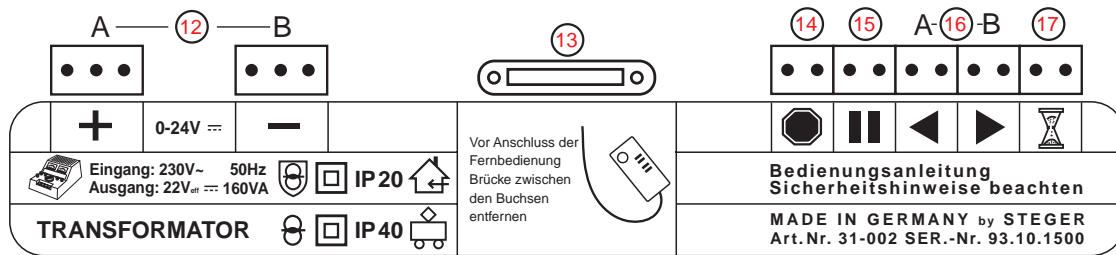

The Jumbo rear panel includes:

- (12A/B) Triple track power terminals (all output same voltage)
- (13) Remote control connector
- (14) Emergency stop terminals
- (15) Brake terminals
- (16A) Forward terminals
- (16B) Reverse terminals
- (17) Timer terminals

Any simple contact—like a 17100 track contact or a simple switch—can be connected to the function terminals (14 through 17) to control any of the special functions.

Jumbo at Work

The operating capabilities, both manual and automatic, of the Jumbo are quite numerous. Here are some basic examples:

• Train mass simulation

For this "momentum" simulation, set the drive voltage control (1) to "3". Press the Emergency Stop key (4). Set the acceleration control (5) to a middle position, for example, to "3".

If you now press a direction key (2A or 2B), you will see that the voltage does not increase quickly, but quite slowly. The locomotive also starts moving slowly, just like it does on a real train with a heavy load.

If you turn the control (5) to higher numbers the voltage will increase at a slower rate. Once the train reaches the speed set with the drive voltage control, you can bring it to a stop using either the Brake (3) or Emergency Stop (4) touch key.

The acceleration setting is also in effect when you use the drive voltage control (1). When you turn the control quickly to a high setting, for example, to "6", the voltage increases slowly, according to the pre-set acceleration rate.

• Automatic slow track

When the train passes over the 17100 track contact (see Page 111), the timer function of the Jumbo is activated. The train slows according to the deceleration setting and is held at the minimum drive voltage setting until the selected timed period is complete. Then the train accelerates according to the acceleration setting until the speed reaches the maximum drive voltage setting.

This circuit can also be used to automatically slow trains on downhill grades.

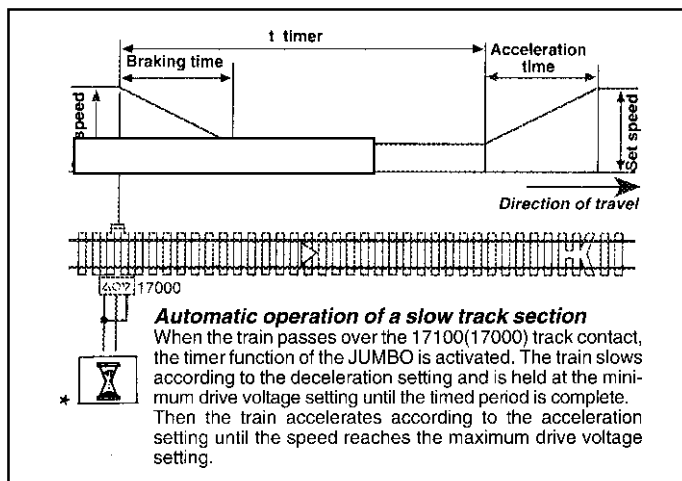

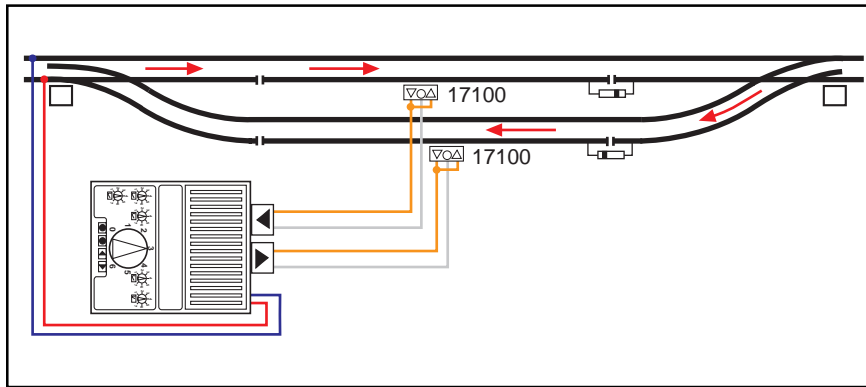

GEMNT

• **Automatic-opposite alternating station**

Here, a train enters the station traveling one direction and stops. A second train then leaves the station traveling in the opposite direction.

With a Jumbo, it's easy to do. All of the action is controlled by two diodes (see Page 118) and two 17100 connected to the key contacts (16A, 16B) on the Jumbo. Pre-programmed manual switches control the routes (see Page 119).

Hint: Don't worry about the doubled control connections to the 17100s. The rules against that (Page 111) don't apply to the Jumbo key contacts.

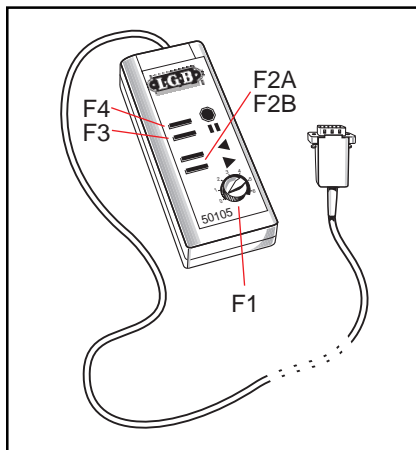

• **Remote Control**

With the 50105 Wired Jumbo Remote Control, you can follow your trains around your layout, operating them with more precision than ever. With the Jumbo Remote Control, you can use the Jumbo to power an outdoor layout. Just keep the Jumbo indoors and use the remote outdoors.

The Jumbo Remote Control is connected to the back of the Jumbo via a 9-pin connector (13). The included 12 m (39 ft) cable can be extended up to 30 m (98 ft) using RS-232 cables, available from computer and electronics suppliers.

The Jumbo Remote Control includes:

- (F1) Drive voltage control
- (F2A) Forward
- (F2B) Reverse
- (F3) Brake (with pre-selected deceleration)
- (F4) Emergency stop (with no delay)

LGB Power Around the World

The LGB program includes power supplies for use in many different countries:

- 230 volt power supplies designed for use in many European countries are usually designated with a "0" as the final digit of the model number (e.g., 50060).
- 110 volt models designed for use in North America are also available. These models are usually designated with a "1" as the final digit of the model number (e.g., 50061). 110 volt models have gray cases, and the specifications may vary from the corresponding 230 volt models.
- Other voltage models designed for use in other markets may also be available. For more information, visit your local LGB retailer.
- Power output specifications are maximum ratings.
- All products and specifications are subject to change. Please see the current LGB catalog for updated information.

Attention! For safety and reliability, Lehmann does not recommend the use of non-LGB power supplies with LGB trains. Some of these power supplies produce excessive voltage, and some produce damaging "spike" or "pulse" waveforms that can harm LGB motors and electronics. Some are not approved by recognized safety agencies, like "UL" and "GS."



Outdoor Power

With the LGB power program, you can safely use electricity to power an outdoor layout. There is just one simple rule you must obey:

Any device connected directly to house current must be kept indoors or in a weather-protected enclosure.

For example, all LGB transformers connect directly to house current.

They must be kept indoors or in a dry, weather-protected enclosure.

But if transformers have to be kept indoors, how can you power an outdoor layout? It's easy. That's why the LGB program includes separate transformers and speed controls. You keep the transformer indoors and install an appropriate speed control outdoors.

The connection between the transformer and speed control can be made with relatively small, low-voltage wires. The wires can be routed permanently (e.g., through a small hole in a wall) or temporarily (e.g. under a window pane).

Selected LGB speed controls, like the 51120 "Signalman's Hut"

Electronic Throttle, are engineered for outdoor use. The 51120 can be exposed to the weather without any protection. The 51750 Momentary Control Box and the 51800 On/Off Control Box are made for outdoor use also. They have built-in covers to protect them from the weather.

LGB speed controls intended for indoor use, like the 50070 Indoor Electronic Throttle or the custom 50121 Unmounted Electronic Throttle, can be installed outdoors in a dry enclosure. For these low-voltage devices, weather protection is not as critical as with house current devices.

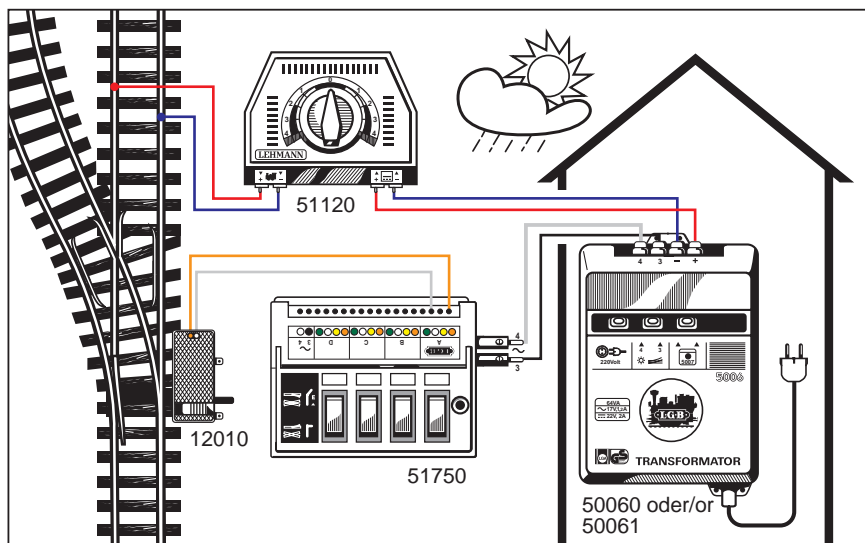

LGB Q&A

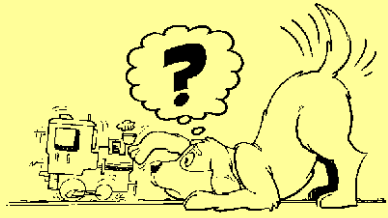

How much power do I need?

This is a very difficult question, because it raises many other questions: How many cars are you trying to pull? Do the cars have two axles or four? Do they have regular or ball bearing wheels? How many locomotives are you using? Do they have one motor each or two? Do they have sound? How fast are they going? Are there grades on your layout? Are there curves? Is the track clean? How clean?

You can make a very, very rough estimate of your layout's power requirement by looking at your locomotives. Add 0.75 amp for each motor in each loco on your layout. (Remember, some LGB locos have two motors.) Add another 0.50 amp for each loco (or sound car) with electronic sound. For example, let's say you are "double heading" two LGB F7-A locos along with a F7-B sound unit...

20570 Santa Fe F7-A, 2 motors, no sound	1.50 amps
20570 Santa Fe F7-A, 2 motors, no sound	1.50 amps
20582 Santa Fe F7-B, 0 motors, sound	0.50 amps

Estimated power requirement	3.50 amps
------------------------------------	------------------

If your estimated power requirement is less than 2 amps, the classic "5006" AC/DC Transformer (50060 230 volt, 50061 110 volt) is probably a good choice. Remember, however, that this is only a transformer. With it, you'll also need a separate speed and direction control, like the indoor/outdoor "Signalman's Hut" Electronic Throttle (51120).

If your estimated power requirement is 2 amps or more, the top choice is the big Jumbo Power Pack (50100 230 volt, 50101 110 volt). With a maximum continuous output of 10 amps and a wealth of special features, the Jumbo can satisfy virtually every track power need. For Multi-Train System layouts, the top choice is the high-output 5 amp AC Transformer (50110 230 volt, 50111 110 volt).

This "A-B-A" combination of LGB F7 locos requires an estimated 3.5 amps of power.



LGB Q&A

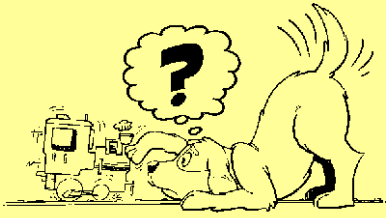

Can I use a car battery to power my layout?

Yes. This is a good idea if your layout is far away from a house current outlet, for example, in a community garden. All you need is a battery, a fuse and an LGB 51120 Electronic Speed Control.

You can use a regular 12 volt automotive battery or a "deep cycle" battery, like those made for boats and recreational vehicles. (If you need more voltage, say for a loco with sound, you can connect two batteries in series to produce 24 volts.) You can use a regular automotive fuse rated up to 10 amps.

The connections are simple. Connect the positive terminal on the battery to the positive terminal on the speed control. Connect the negative terminal on the battery to the fuse. Connect the fuse to the negative terminal on the speed control. Then connect the speed control to the track, as you would normally.

Will the trains drain the battery quickly? Probably not. At full speed, an LGB loco with a single motor requires less than 18 watts of power, far less than a household light bulb. Problems? Batteries produce DC only. They cannot directly provide the AC electricity you need to operate LGB accessories like switches and signals.

Batteries can be used to power layouts in remote locations, like community gardens.

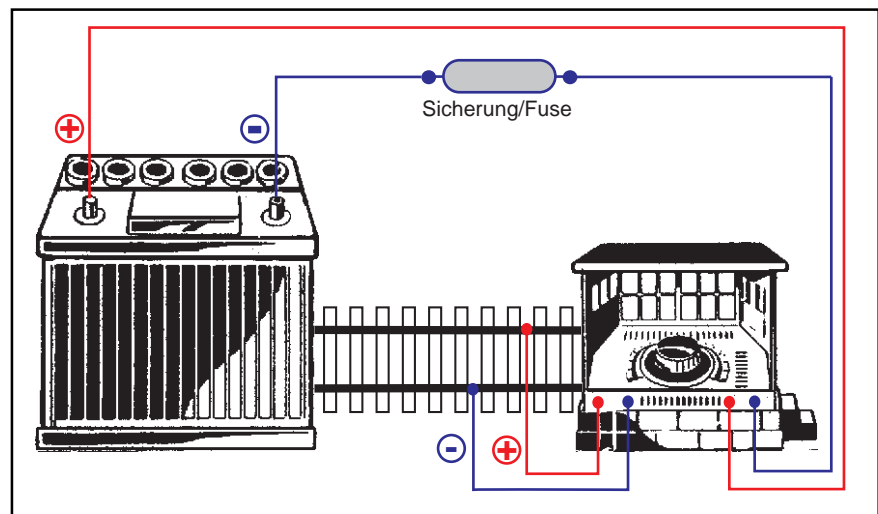

Discoveries: Torture on the Tracks

Story and Photos by Heinz Koopmann



E.P. Lehmann's chief technical consultant, Heinz Koopmann, tests a locomotive on an LGB torture track (below).

When Eberhard and Wolfgang Richter created the first LGB train, they wanted a reliable train. They wanted a train that would operate indoors and outdoors without derailing, without uncoupling and without crashing.

This is a difficult goal, especially for outdoor layouts. Outdoors, the track situation changes constantly, because of weather and because of the creatures that inhabit the area around and under the track. Therefore, it is necessary to design locos and cars very carefully so that they can tolerate all kinds of situations.

This requires extensive “road testing” of model prototypes during the development stage of a new product. To aid in this process, a standard test layout was created. This “torture track” contains a large variety of LGB track combinations, replicating all kinds of operating situations. This allows us to detect defects in the prototypes before they reach production.

To aid in testing, four of these test tracks were constructed. Three are in constant use. The fourth is needed as a backup because of the constant wear on the layouts in use. Generally, the trains tested on the track are not finished to the last detail. For example, the photo here shows a prototype LGB/Aster Shay during gearbox testing.

It takes many efforts like this to develop a new train that will go around and around your layout without derailments. Sometimes the introduction of a new product is delayed because an unexpected problem is suddenly detected on the test track. However, finding these problems is the key to making each new LGB train as reliable as Eberhard and Wolfgang wanted the first LGB train to be.

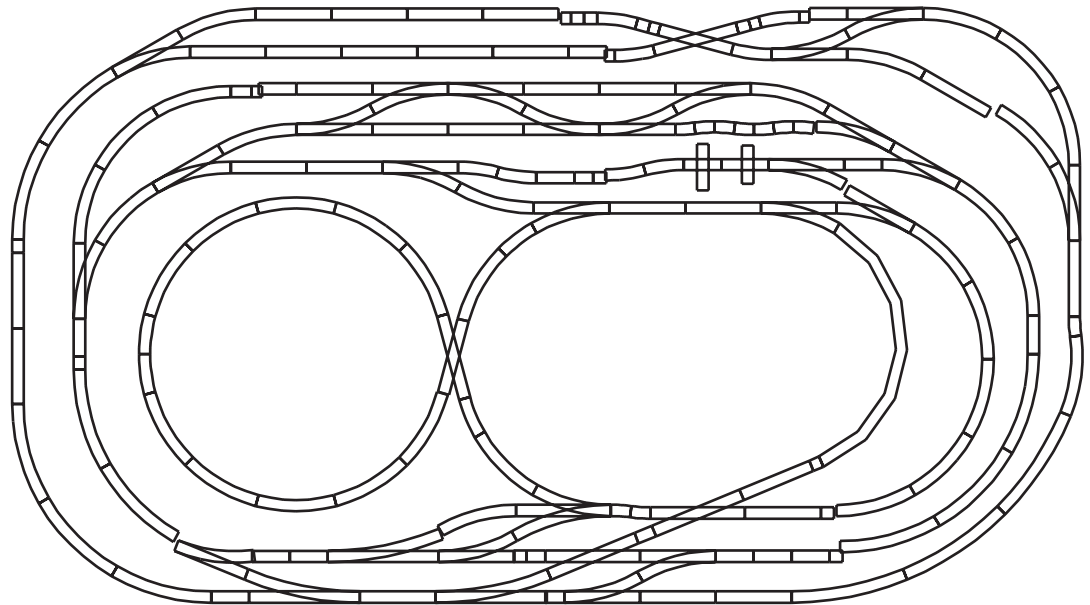

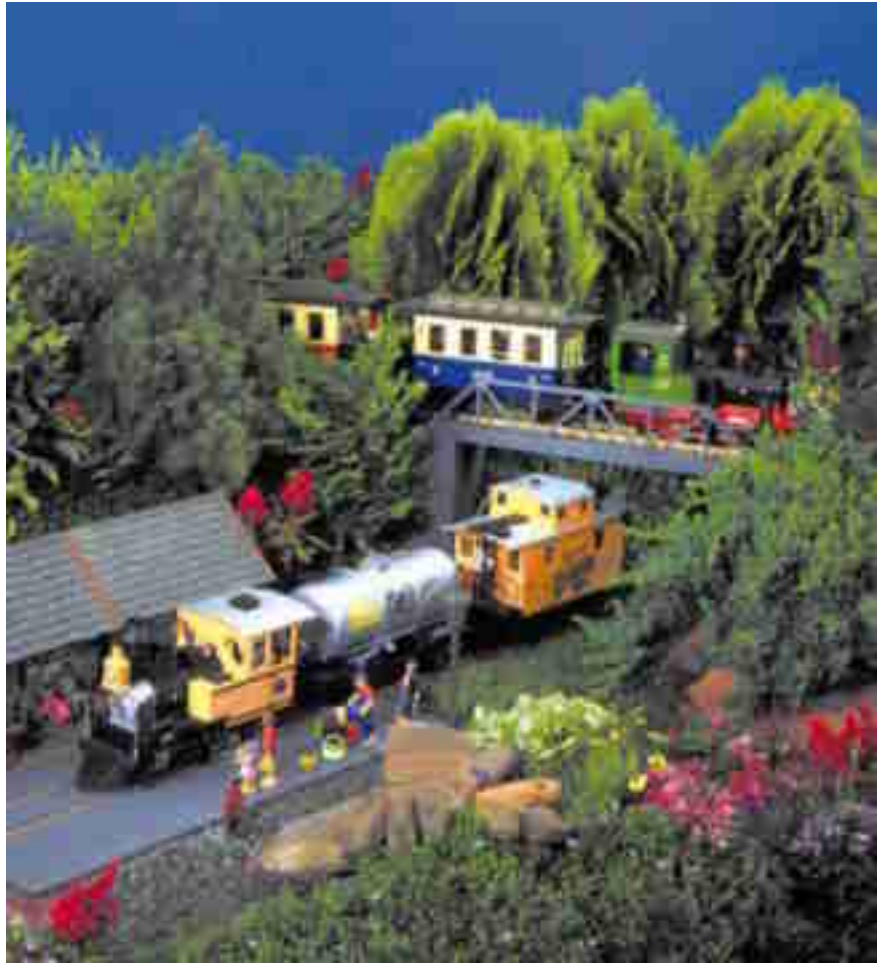

CHAPTER 9: TAKING CONTROL

The LGB "EPL" system lets you control trains, switches and accessories for realistic, automatic operation.

Big LGB layouts can be impressive...and a bit intimidating. Trains are moving everywhere. Starting. Stopping. Going forwards. Going backwards. Passing each other on the main line. Avoiding each other at stations.

It looks wonderful, but it may also look impossible. How can you control such a complex dance of track and trains?

Actually, it's easy. You only have to remember two simple principles:

1. LGB trains run on power transmitted through the track.

2. By controlling the power in the track, you can control the trains.

The LGB system of train controls is based on those simple principles, and with some simple circuits using LGB "EPL" and other components, you can create an impressive layout of your own.

Circuit 1: Track Power Connection

The most important circuit in the entire system is the most simple: the track power connection.

What is it? The track power connection is the connection between the power pack (or speed control with transformer) and the track. You made this basic circuit when you assembled your first LGB starter set. The set came with a two-wire cable. You connected one end of the cable to the DC terminals on the power pack. You connected the other end of the cable to the track.

It may seem silly to mention something so simple, but the track power connection is the logical cornerstone of many other train control circuits. If you connect power to the track, the trains will run. If you disconnect power to the track, the trains won't run.

Hint: You don't have to disconnect both wires to stop the trains. Disconnecting just one wire will break the circuit and do the job.

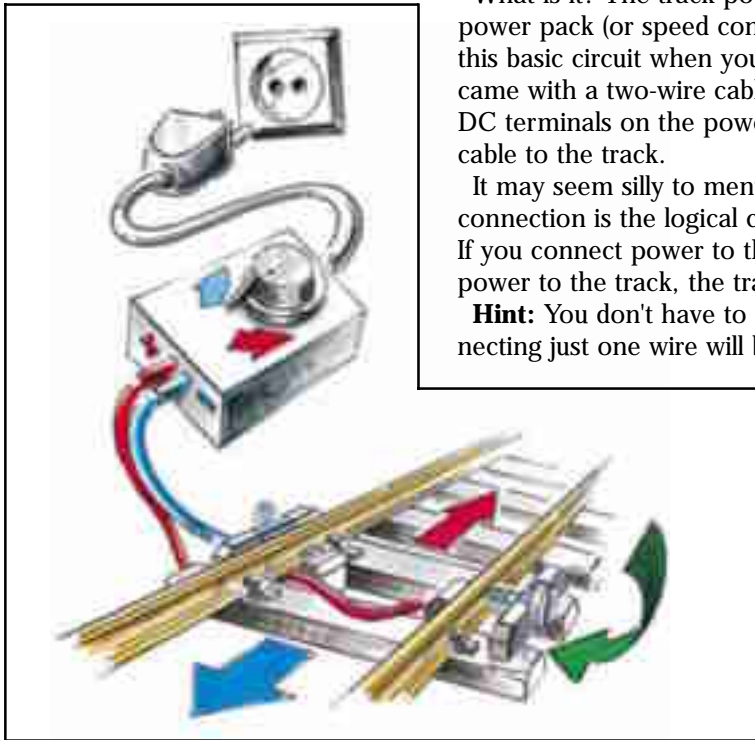

Connection Techniques

The LGB program offers you several convenient ways to make track power connections:

- **50160 Track Power Cable.** This two-wire (red/blue) cable is similar to the quick-connect cable found in LGB starter sets. There are two factory installed terminal clamps on one end of the cable. The terminal clamps fit under and around the track rail. A thumb screw firmly attaches the clamp to the rail (Page 105, top).

Attention! Do not use the 50160 with an LGB Jumbo Power Pack. The wires in this cable are not large enough to handle the output of the Jumbo. With the Jumbo, use LGB 51230 connecting cable (red/blue, 1.5 mm² wire cross section, 14 AWG).

- **50161 Track Power Terminals, 2 pack.** These are the same terminal clamps used on the 50160, but you must install your own wires.

To install a wire in a 50161, remove the thumb screw from the clamp. Remove the metal strip from the plastic base. Route the wire through the hole in the base. Strip a small amount of insulation from the wires. Solder or crimp the wire to the lug on the bottom of the metal strip. Reassemble.

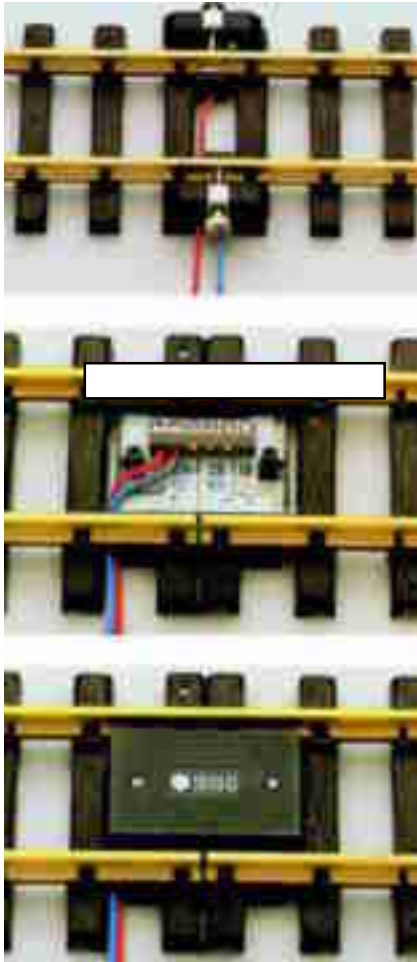

Hint: In most cases, it is only necessary to strip a small amount, less than 6 mm (.25 in), of insulation from wires. Exposed, uninsulated wires can cause short circuits.

• **Insulated Track Sections.** The LGB program includes three insulated track sections:

- 10152 Insulated Track, Double, 150 mm
- 10153 Insulated Track, Single, 150 mm
- 11152 Insulated Track, Double, R1, 15°

At first, these look like ordinary make-up track sections, but look at the rails. You'll see an insulating gap cut in one or both of the rails. (The "single" 10153 has one insulated rail. The "double" 10152 and 11152 have two insulated rails.) Now, look between the rails. You'll see a plastic cover fastened with two screws. Remove the screws and the cover, and you'll find a terminal strip (left). The terminals are connected to the rails.

These terminals offer an easy and attractive way to make your track power connections. Just make your track power connections to the appropriate blue and red terminals. (To bridge the insulation of the lower rail shown here, install a jumper wire between the "2A" and "2B" terminals for that rail.) Then replace the cover. The connection is concealed, but easily accessible.

Since the 10152 and 10153 are 150 mm straight sections, they can be combined with a regular 150 mm 10150 straight section to replace a 10000 straight section. Since the 11152 is a 15° R1 curved section, it can be combined with a regular 15° R1 11020 curved section to replace a 11000 curved section.

• **Soldering.** It is possible to solder wires directly to the track, but this old model railroading technique can be difficult with LGB track because of the size and hardness of LGB rails. Also, soldering connection wires will make it more difficult to change or remove the track in the future.

However, soldering can be useful in some special situations, for example, on hinged track sections. Before soldering, clean the rail thoroughly with a wire brush and soldering flux. A 300 watt soldering iron will heat the rail sufficiently, but be careful not to melt the plastic ties.

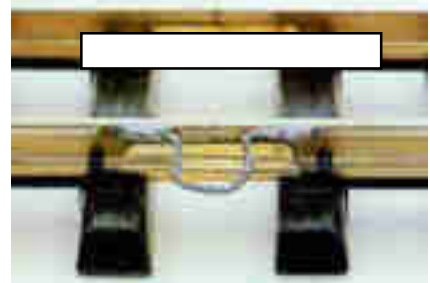

Soldered connection wires can be used to provide power for hinged track sections.



Alternative LGB Energy



All LGB trains produced today operate on track power, that is, electricity transmitted to the train through the track or through a combination of the track and overhead catenary wiring.

But there have been a few LGB trains that don't run on track power. In the early days of LGB, Lehmann produced several simple battery powered trains that ran on plastic track. (These trains are highly prized by LGB collectors.) In 1989, Lehmann also offered the LGB/Aster "Frank S." live steam locomotive (left). It works like a real steam loco, with a gas burner that heats water to create steam.

Also, some LGB owners operate their locomotives with on-board, rechargeable batteries, like those used in radio-control race cars. The appeal of this technique is limited by short operating times and long recharging times.

Indeed, for most LGB fans, conventional track power remains the best choice for simple, convenient operation...which is what LGB railroading is all about.

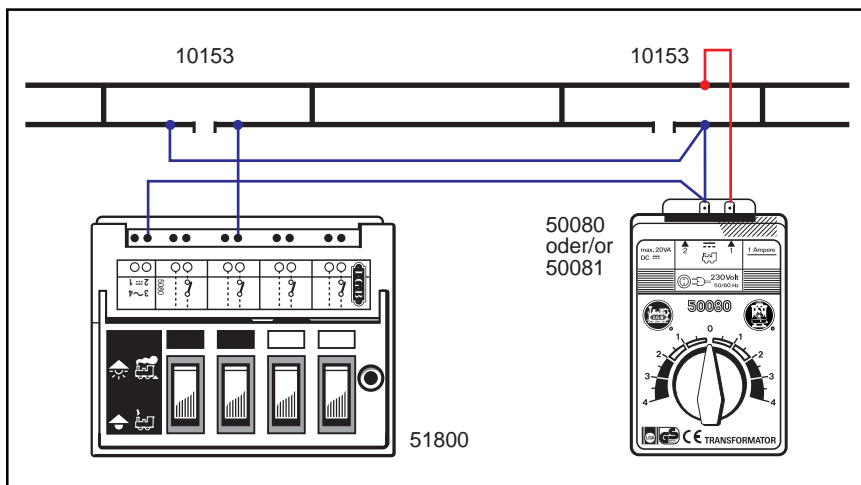

Circuit 2: Manual Track Block

The track power connection allows you to control whether your trains will run or not. However, it is a crude control. Make the connection, and all the trains on the layout will run. Remove the connection, and none of them will run. What if you want to run one train and park another? What if you want to run two trains on the same layout?

The solution is an isolated track block.

In this example (left), two 10153 Insulated Tracks are used to create

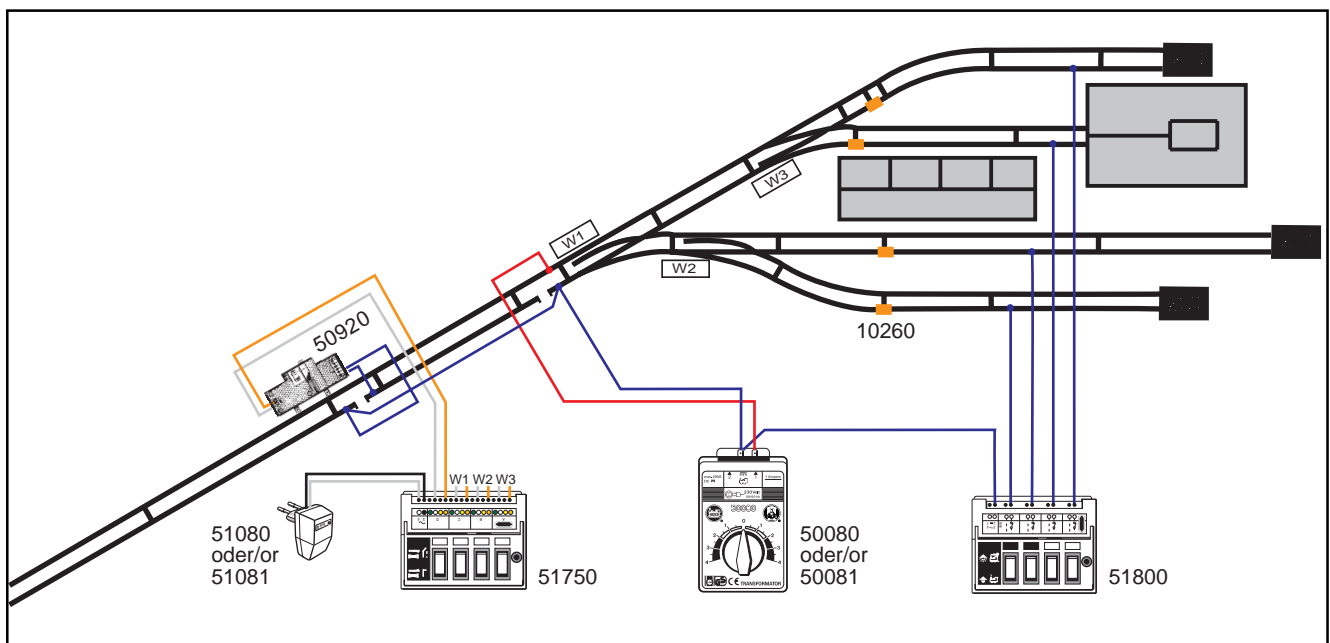

an isolated track block. Power to this block can be manually controlled with a 51800 On/Off Control Box (or any single-pole, single-throw switch you happen to have). With this arrangement, a locomotive can be parked in the block while another locomotive is operating.

Hint: The jumper wire connecting the "hot" sides of the insulated track sections isn't always necessary. It's smart to include it to preserve the electrical continuity of the layout no matter what changes you might make in the future.

The number of isolated track blocks you can have on your layout is unlimited. For example, this locomotive service yard (page 106, bottom) features four sidings with four blocks for parking locomotives. (It also includes a signal-controlled block, a feature we'll review later.)

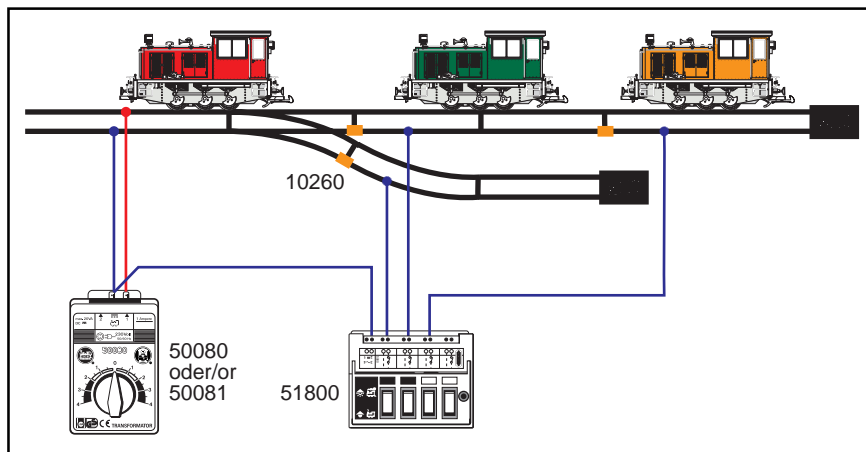

However, the blocks don't have to be on separate tracks. In this example (above left), one track section has two blocks in a row. The third block, on the siding, makes it possible to extract any of the locomotives from the main track. Additional 51800 On/Off Control Boxes can be "piggy-backed" to control a large number of blocks.

Finally, the isolated track blocks do not have to share a single power supply. You can connect a separate power supply to each block. Here (below left), 10260 Insulated Rail Joiners are used, together with two LGB power packs, to create two isolated blocks.

With this arrangement, two locomotives can be operated independently at the same time, as long as the locos are kept in their individual blocks. Also, a loco can be moved from block to block, if the power packs are set to the same speed and direction.

Hint: For any circuit with an isolated track block to work properly, your trains must be "electrically" shorter than the length of the isolated track block. The electrical

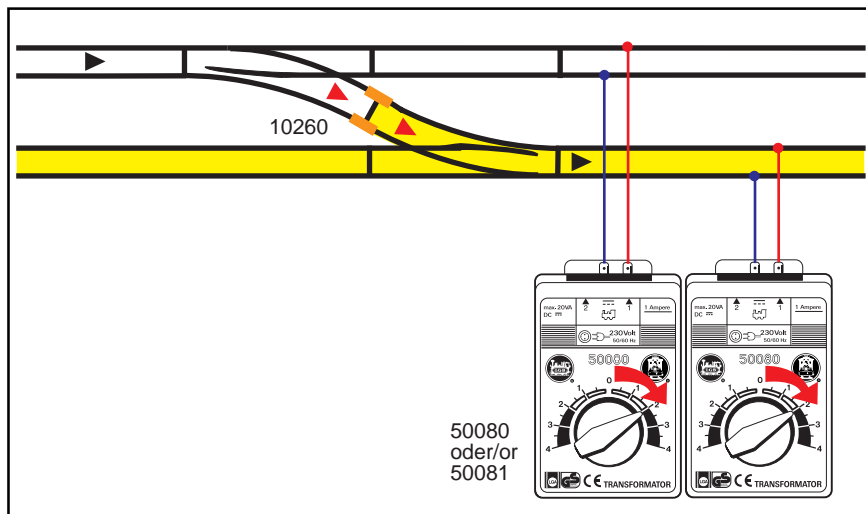

length of your train is the distance between the first and the last electrical pickup on the train.

If you are using a small loco, like a starter set Stainz, that distance is very short. However, if you are using a large loco that is electrically connected to cars with their own power pick-ups (e.g., lighted passenger coaches), that distance may be very long. When you design your layout, make sure the blocks are long enough for your trains.

Using Insulated Rail Joiners



10260 Insulated Rail Joiners are useful where there is not enough room to install insulated track sections, for example, in stations and freight yards. These plastic joiners block the flow of electricity from rail to rail.

To install a 10260, you must remove the original metal rail joiner. Use a small slotted-head screwdriver to bend the tab that holds the metal joiner to the ties. Then, use pliers to loosen and remove the metal joiner. (To make this easier, you can drill out the "dimple" on the bottom of the metal joiner.) Then slide the new insulated joiner on the rail.

Insulated joiners do not hold as tightly as metal joiners. When using insulated joiners, you can use 11500 Track Clips to prevent the track sections from pulling apart.

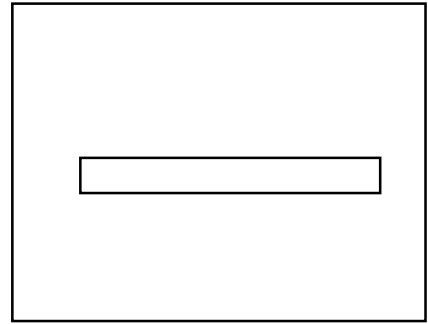

EPL Components

With the first two circuits, you can control trains manually, but with the LGB EPL system you can do more. You can make trains stop automatically at stations and signals. You can create hassle-free reversing loops. You can make two trains run automatically around your layout. In fact, you can do almost anything with the EPL system.

What is the EPL system? It is a program of LGB products you can use to create semi-automatic and automatic train controls. It includes:

- **10151 Reverse Loop Track Set.** This set includes two 150 mm straight track sections. One of those sections includes a special diode circuit for simple reversing loop wiring. The other section has two insulated rails, like the 10152.



- **12010 Switch Drive.** This is the drive mechanism found on LGB electric switches. The 12010 operates on AC power controlled by a 51750 Momentary Control Box or 17100 Track Contact.

Color-coded (orange and white) terminals can be found on the end of the drive.



- **12030 Supplementary Switch.** This double-pole, double-throw switch attaches to the end of a 12010. Together, the 12030 and 12010 make a relay that can be used in a wide variety of train control circuits. The relay connections are illustrated by a diagram molded into the body of the 12030.

Hint: A 12030/12010 relay can be used with or without a track switch.

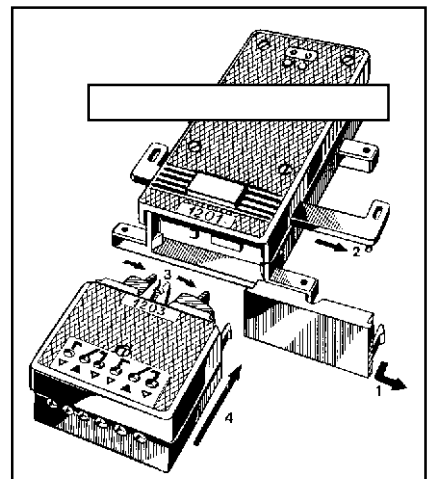



- **12040 Switch Lantern.** This lantern attaches to the side of a 12010. It provides a quick visual indication of the position of the switch. To operate the light inside the lantern, the 12040 needs power: AC, DC or Digital AC direct from the track on a Multi-Train System layout.



- **17010 Magnet.** This thin magnetic strip attaches to the bottom of most LGB locomotives. It is used to trigger a 17100 Track Contact.



- **17100 Track Contact.** This track-mounted device is designed to automatically control EPL drives in switches and signals. (It can also be used to trigger other LGB devices, like the 50100 Jumbo and 53750 Timer.)

When a locomotive equipped with a 17010 Magnet passes over the 17100, the reed switch inside the 17100 closes and sends a pulse of electricity to control the EPL drive. Diodes inside the 17100 control which direction to move the drive.

Under a plastic cover, the 17100 has three connection terminals: a center "input" terminal (⊗) and two outer "control" terminals (Δ and ∇).

- **51750 Momentary Control Box.** This orange control box is used to control EPL switch and signal drives. Under the main cover, you will find a power "on" indicator light and four momentary-contact switches wired to internal diodes.

Under the smaller rear cover you will find color-coded connection terminals. The black and white (3 and 4) terminals are used to connect the box to the AC output of an LGB power supply. The A, B, C and D terminal sets are used to connect the box to switches and signals. The orange and white terminals match the orange and white terminals on EPL switch and signal drives. The yellow and green terminals are only used for old LGB three-wire switch drives.

The removable side pins carry AC power (3 and 4) and can be used to "piggyback" several 51750 boxes together. If you remove the pins from the side, the remaining sockets can be used to connect the 51750 to the AC output of an LGB power supply.





• **51800 On/Off Control Box.**

This yellow control box is used to switch power on and off. It can control track power (DC) or accessory power (AC). Under the main cover, you will find a power "on" indicator light and four single-pole, single-throw "on/off" switches. Under the smaller rear cover you will find connection terminals.



The removable side pins can carry AC or DC power (not both) and can be used to "piggyback" several 51800 boxes together. 51800s controlling AC and DC should not be joined together.

• **52750 EPL Booster.** This red box provides extra energy to operate 12010 Switch Drives under unfavorable operating conditions. We strongly recommend using the 52750 in any EPL circuit where reliable drive operation is important.

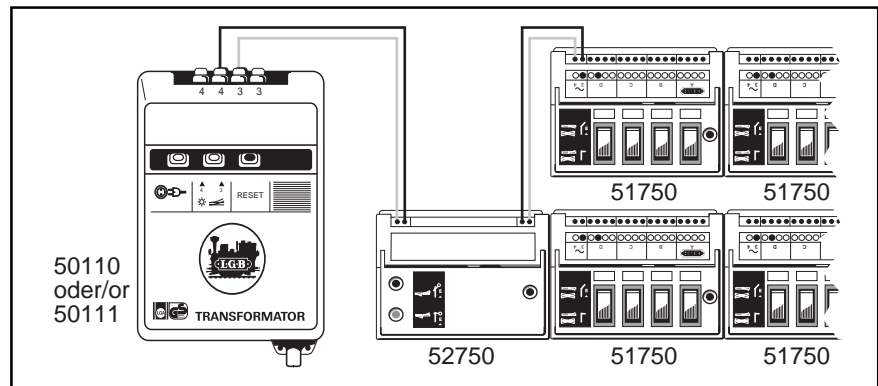

The 52750 is connected between the AC power supply and 51750 Momentary Control Box and/or 17100 Track Contacts. The 52750 should not be connected to other AC devices, like lanterns.

• ~~**53750 Timer.** This brown box features a variable electronic timer (2-240 seconds) that controls a double pole, double throw relay. The timer can be activated manually with a 51750 Momentary Control Box or automatically with a 17100 Track Contact.~~

~~The 53750 has countless train control applications. For example, it can be used, with a 17100, to automatically stop a train at a station and restart the train after a timed period (see Page 165).~~

Hint: All of the EPL boxes—the 51750, 51800, 52750 and 53750—share the same housing. All of the boxes can be installed outdoors without any additional weather protection.

LGB signals are also an integral part of the EPL system. You'll find a full discussion of signals in Chapter 11, but review this chapter to learn some of the basic concepts behind all EPL circuits.

LGB Q&A

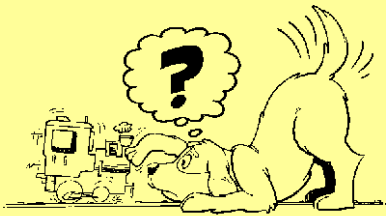

How Do EPL Drives Work?

EPL drives, in both switches and signals, operate on AC power, and they take advantage of the fact that AC power is a wave, that is, it oscillates in both voltage and polarity.

That AC wave can be chopped in half using a diode. EPL drives are designed to use this "half-wave" power, moving in one direction if they receive the top half of the wave and moving in the other direction if they receive the bottom half of the wave.

These diodes are built into the 51750 Momentary Control Box and the 17100 Track Contact. When you push the button on the box or when a train passes over the contact, power passes through one of the diodes and sends a half-wave to the EPL drive.

Although EPL drives only require a short pulse of half-wave power to operate, they are designed to withstand continuous power. That can happen when a locomotive is stopped above a 17100 Track Contact.

However, EPL drives will not function properly if they receive both halves of the AC wave at the same time. Instead, they will oscillate, bouncing back and forth at the current frequency, 50-60 cycles per second. Oscillation problems are often caused by connecting control wires to both outer "control" terminals (Δ and ∇) of a 17100 Track Contact.

Here are some more useful tips to remember when working with the EPL system:

- Sometimes, EPL drives need a bit more power to overcome mechanical resistance in the switch (from dirt or from an attached 12030) or to overcome electrical resistance (from long wire runs). The 52750 EPL Booster will provide that extra power, and we strongly recommend it for reliable drive operation. A dedicated AC power source, like the 50110/50111 AC Transformer, is also helpful.

This chart shows the relationship between the 17100 connection and the drive position for switches (above) and signals (below).

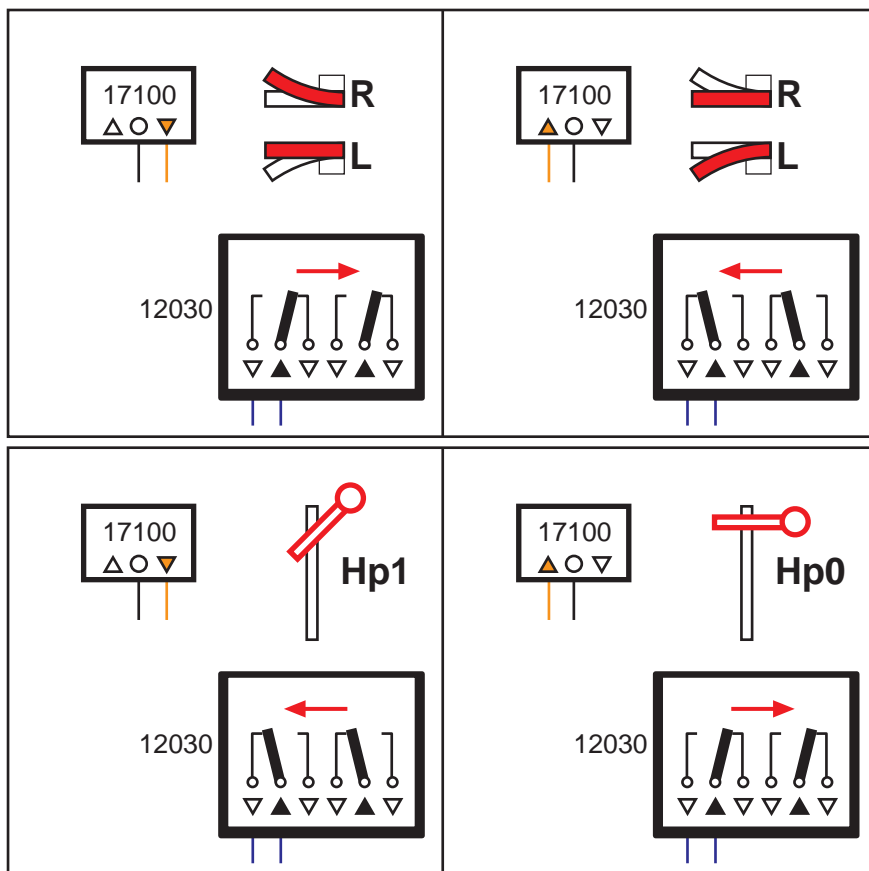

- A small number of EPL drives have been manufactured with the orange and white terminal connections reversed internally. If a drive does not operate as expected, try reversing the connections to the drive.

- Do not try to control more than one EPL drive (switch or signal) with one 17100 Track Contact.

- Do not connect AC power directly to a 17100 Track Contact. This can destroy the contact. The circuit must include another device, like a 12100 Switch Drive.

- Do not connect wires to both outer "control" terminals (Δ and ∇) of a 17100 Track Contact.

- When used to control an EPL drive, the outer "control" terminal (Δ and ∇) connection on a 17100 determines the position of the EPL drive (and the 12030 connected to the drive). This chart shows the relationship between the 17100 connection and the drive position.

- When used to control an EPL drive, the center "input" terminal (⊗) of a 17100 Track Contact is usually connected to AC terminal "3" on an LGB power supply. One of the outer "control" terminals (Δ and ∇) of a 17100 is connected to the orange terminal on the EPL drive. The white terminal on the EPL drive is connected to AC terminal "4" on an LGB power supply.

These conventions are used to simplify complex wiring diagrams, like the classic automatic "point-to-point-to-point" layout shown here.

(This diagram appears to violate the rule against double control connections to a 17100. However, the connections are routed through the "R2" 12030/12010 relay, and only one connection is active at a time. It's a great example of what ingenious minds can do with the EPL system.)

- Because of the technique it uses to improve drive reliability, the 52750 EPL Booster cannot be used to power separate EPL drives in different directions at the same time. In this situation, two separate 52750s should be used.

- Track connections "1A," "2A," "2B" and "1B" refer to terminals on LGB insulated track sections (10152, 10153 and 11152).

- The 17100 has replaced the original 1700/17000 Track Contact. The contacts are functionally identical and can be exchanged in all circuits. The 17100 is smaller, easier to install and more reliable.

- The 51750 and 51800 have replaced the original 5075 and 5080 control boxes. The boxes are functionally identical and can be exchanged in all circuits. The newer boxes feature improved gold-plated contacts.

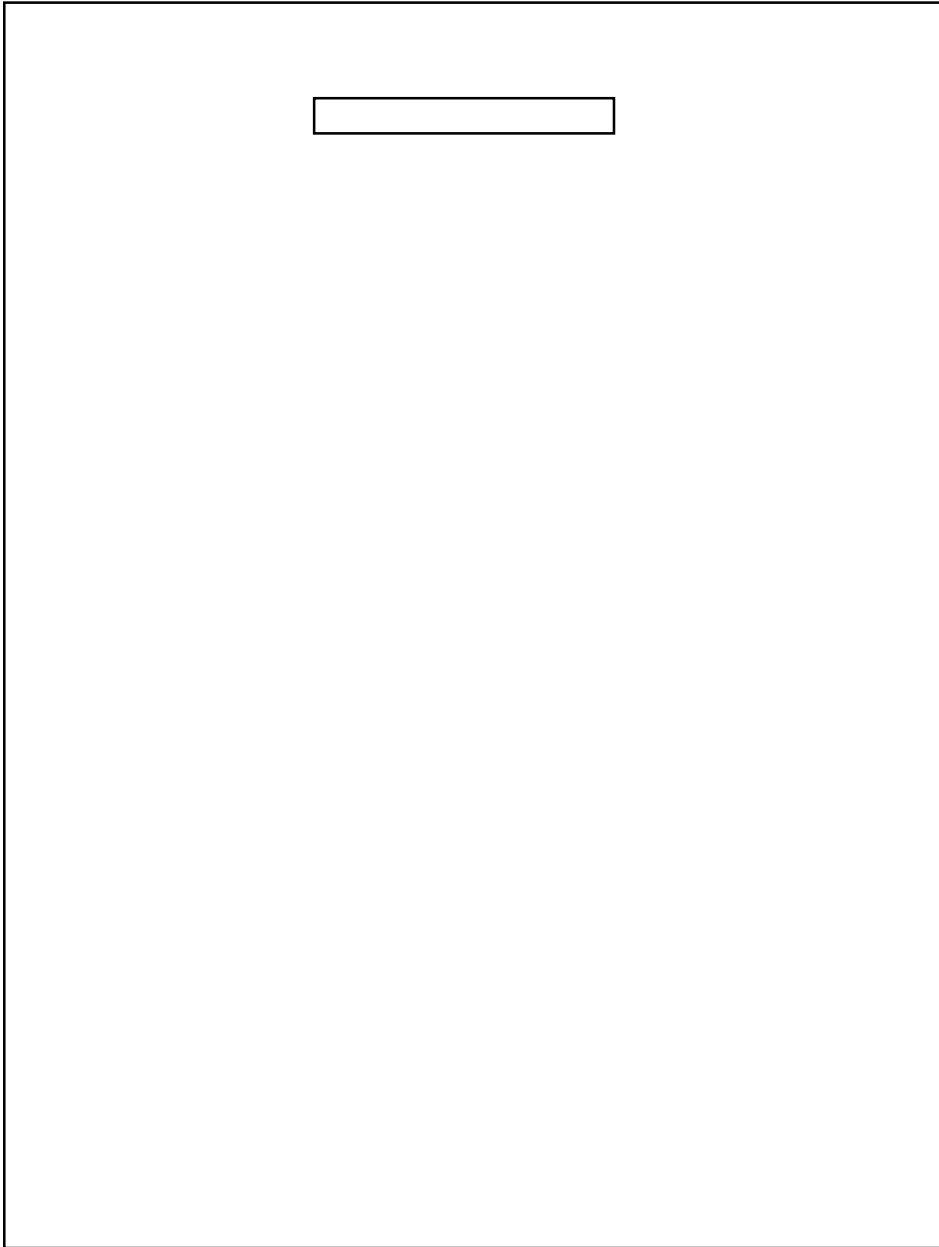

Circuit 3: Semi-Automatic Siding Blocks

Now that we have EPL components, we can begin to automate parts of our layout. With Circuit 2, we built sidings with isolated track blocks, and we manually controlled the power to those blocks with a 51800 On/Off Control Box. Now, we'll let a 12030/12010 relay control the power.

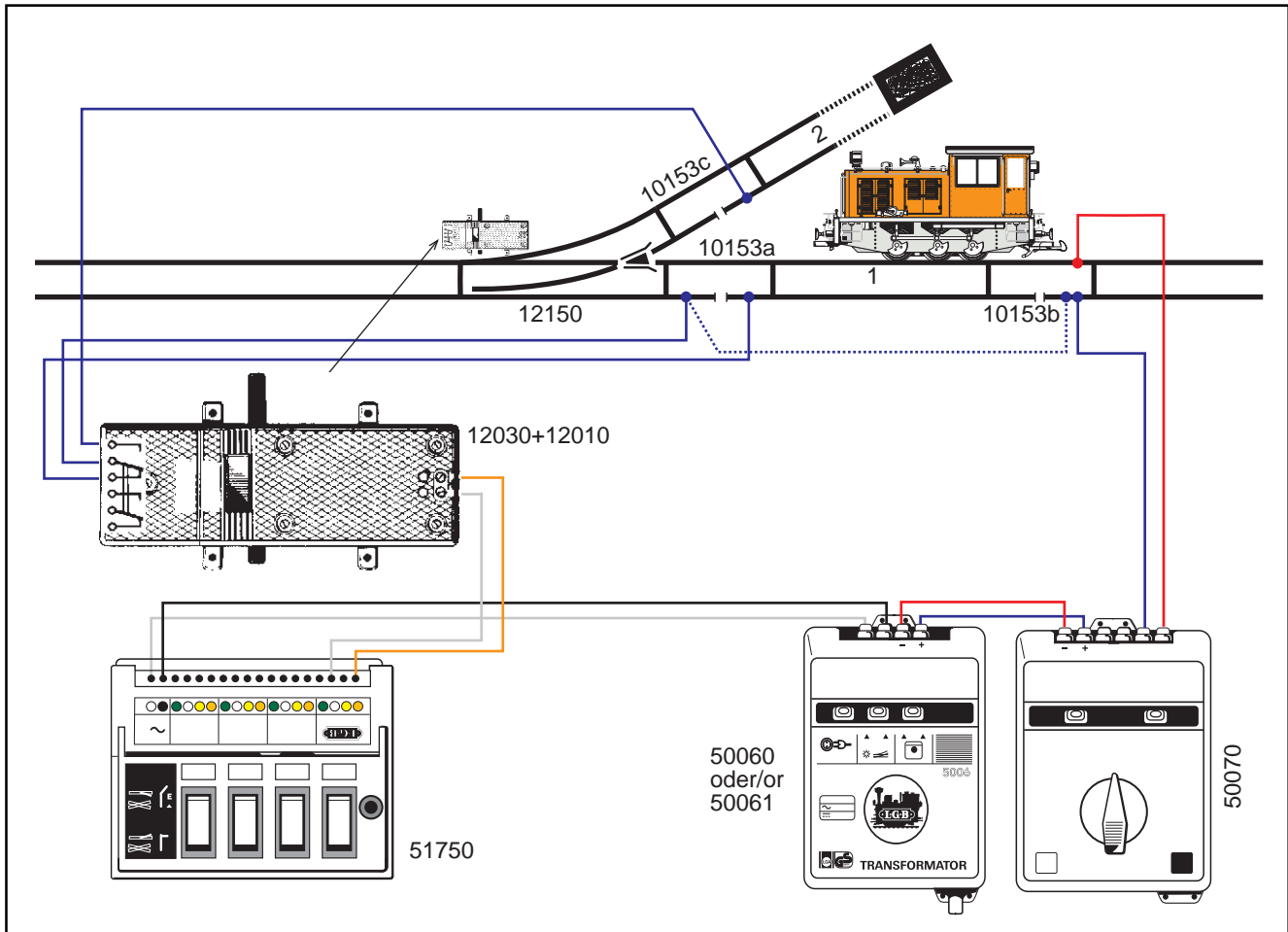

Here, the 12010 is the drive that controls the direction of the switch. The 12030 "Supplementary Switch" is a double-pole, double-throw switch attached to the end of the 12010. With this "semi-automatic" circuit, the 12010 is controlled electrically using a 51750 Momentary Control Box.

The center terminal on the 12030 is connected to the "hot" side of the insulated rail of 10153a. The outer terminals are connected to the "controlled" sides of 10153b and 10153c. The dotted "jumper" wire is optional. It may be necessary to carry current from one side of the main line block to the other.

When the switch is set for main line operation, power is connected to the main line block. No power goes to the siding. When the switch is set for siding operation, power is connected to the siding. No power goes to the main line.

This simple circuit can be used as a safety device. With this circuit, a train cannot enter the main line from the siding unless the switch is set in the proper direction.

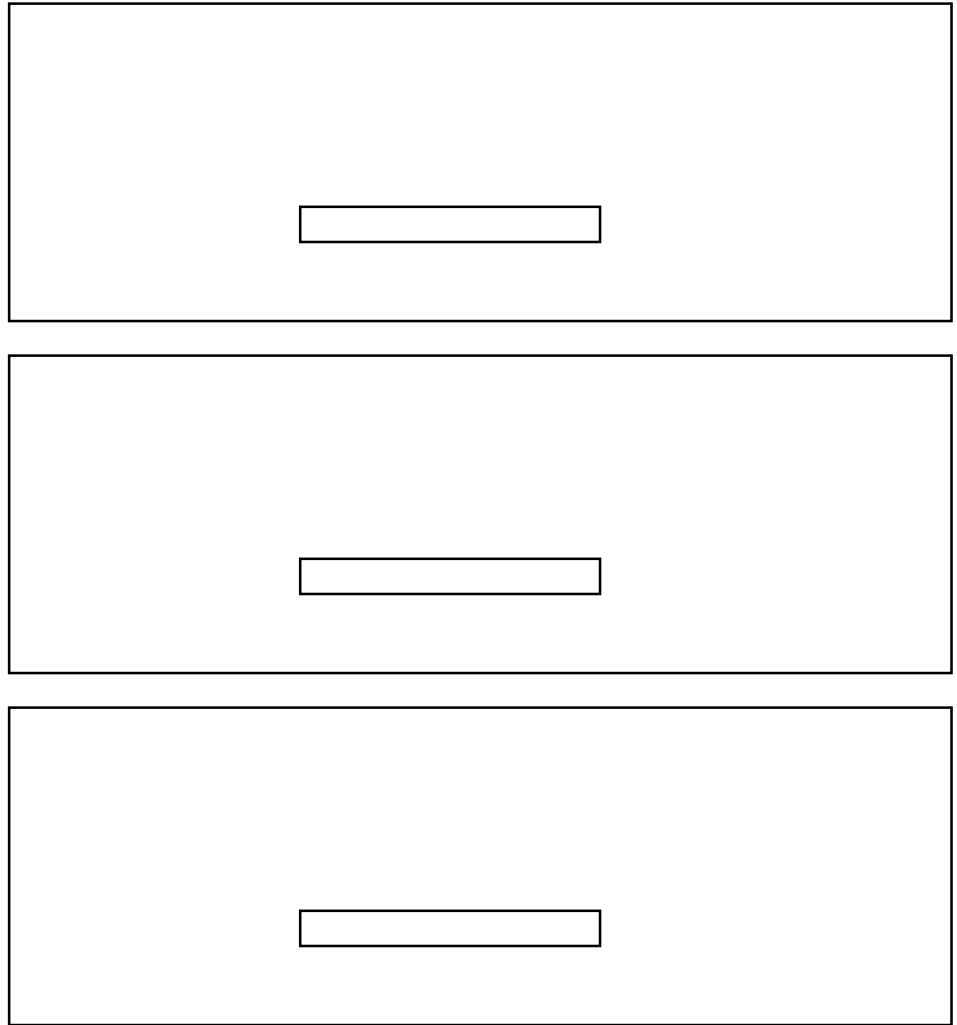

This simple circuit can also be multiplied to create more complex circuits, like this three-track station (top) or this engine yard (middle). In each circuit, the 12030/12010 relays are wired together, so that only one track can receive power at a time.

You can also install these circuits back-to-back. In this example (bottom), there are two isolated track blocks in each siding. The B-side blocks are controlled by the B-side switch. The A-side blocks are controlled by the A-side switches.

Hint: The 12030/12010 relay can be operated manually, as well as electrically. Just push the exposed lever from side to side to throw the relay. This is helpful on large layouts when you may not want to walk back to the control center to operate the relay.

Circuit 4: Automatic Siding Blocks

In the last circuit, you used a 51750 Momentary Control Box to control the 12030/12010 relay. Now, we'll use two 17100 Track Contacts to control the 12030/12010...and we'll enter the realm of automatic operation.

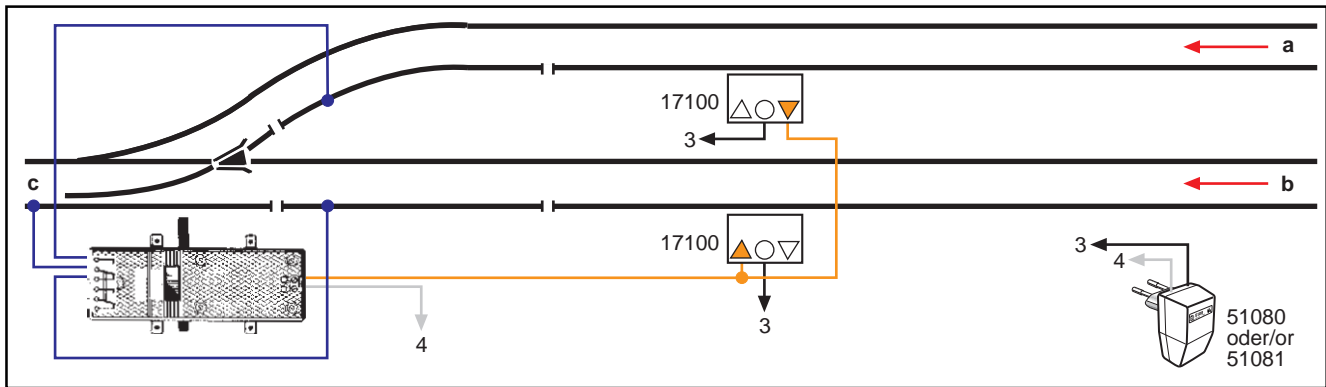

A train enters the circuit from the right on Track A and triggers the upper 17100. When that happens, the 12010 moves the track switch to the straight position since the control wire is connected to the "down" side (V) of the upper 17100. At the same time, the 12030 disconnects power to the isolated track block on Track A, and it connects power to the isolated track block on Track B. (To confirm these movements, see the chart on Page 113.)

As a result, the train on Track A will stop as soon as it crosses into the isolated track block. If there was a train waiting in the isolated track block on Track B, it will start and proceed through the switch onto Track C. The train now waiting in the isolated track block on Track A will stay there until a train crosses the 17100 on Track B. Then the train on Track A will be released and the train on Track B will be held.

**Magnets
Not
Included**

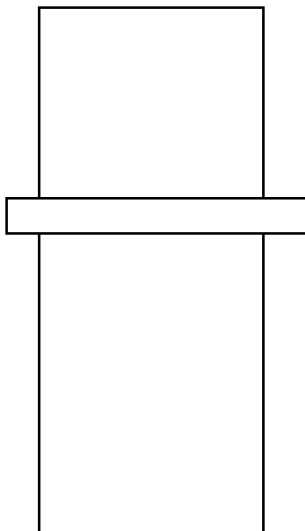

For any circuit with 17100 Track Contacts to work properly, your locomotives should be equipped with 17010 Magnets.

The flat 17010 magnet (57 mm x 22 mm) fits in a pocket molded on the bottom of most LGB locos. The 17010 package also includes glue and a metal mounting bracket, which is required on some LGB locos.

Before you glue the magnet in place, hold the locomotive with one hand and hold the 17010 magnet against the gearbox. The magnet will either be attracted to or repelled from the motor magnets inside the gearbox. To ensure that the magnetic fields do not cancel each other, position the magnet so that it is repelled.

Because of their internal motor magnets, some locos will trigger 17100 Track Contacts without a 17010, but the effect may not be reliable...or even desirable. Sometimes, you may not want a loco to trigger the 17100. For example, you may not want a switching loco to trigger 17100 circuits as it passes through a station.

To prevent undesired triggering, attach a flat piece of ferrous metal (e.g., iron or steel) to the gearbox instead of a magnet. This piece should be the same size as the 17010 magnet and at least 1 mm thick. The mounting bracket included in the 17010 package can also be used for this purpose.

Circuit 5: Alternating Station Circuit

In reality, this circuit is only a slightly modified version of the Automatic Siding Blocks circuit. However, it is so useful and so popular that it deserves individual attention.

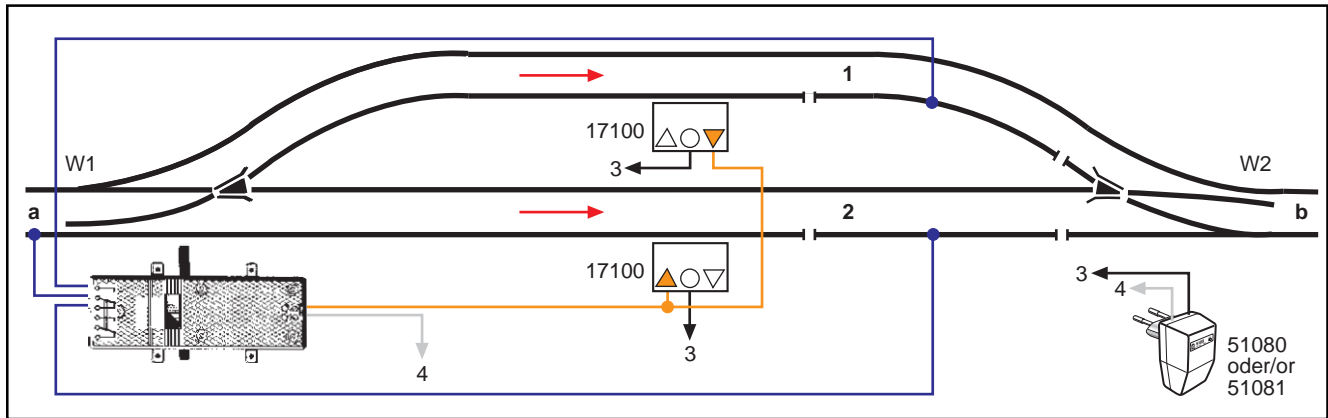

Imagine a train is stopped in the isolated track block on Track 1. Another train enters the circuit from the left on Track A. The first track switch (W1) is set to straight, and so, the new train continues onto Track 2. The train triggers the lower 17100, and the 12010 moves W1 to the turned position since the control wire is connected to the "up" side (D) of the lower 17100. At the same time, the 12030 disconnects power to the isolated track block on Track 2, and it connects power to the isolated track block on Track 1.

The train on Track 2 will stop as soon as it crosses into the isolated track block. The train waiting in the isolated track block on Track 1 will start and proceed through the manual track switch (W2) onto Track B. (The setting on the manual switch is not important. See **Using Manual Switches** for more information.)

The train now waiting in the isolated track block on Track 2 will stay there until the train that was on Track 1 returns. Then the train on Track 2 will be released and the train on Track 1 will be held.

If you install this circuit in an oval layout, this process will keep repeating itself...forever. One train will leave the circuit, circle the layout, return and stop. The other train will leave the circuit, circle the layout, return and stop. Add a few buildings to the circuit and you have a great representation of a real train station. That's why this circuit is so popular. It installs easily, works automatically and looks great.

Hint: On this circuit and others with isolated track blocks, a jumper wire may be necessary to carry current from one side of the block to the other.

Using Manual Switches



Normally, you use track switches to control your trains. However, LGB manual switches are also useful when you don't want to control your trains.

First, let's define a few terms. The "points" (a) of the switch are the two rails in the center that slide from side to side. The "entrance" (b) is the single track that leads through the points to either of the two "branches," the "straight branch" (c) and the "curved branch" (d). The "manual switch drive" (e) is a small box with a small control lever. It can be attached to either side of the entrance.

The points on an LGB manual switch are spring loaded, by the manual switch drive, to hold the points in position. If you push the points with your finger, you'll see that the spring tension on the points is very light. A train entering the switch through either of the branches can overcome that tension and push the points in the proper direction.

That is why a manual switch is used in circuits like the Alternating Station Circuit (Page 116). It doesn't matter how the manual switch is set, trains coming through either of the branches will push the points in the proper direction.

Sometimes, very light trains will not be able to overcome the spring tension in the points. In those situations, you may simply want to remove the manual switch drive. As long as traffic only flows into the branches, not the entrance, no drive is necessary.

Finally, some LGB operators "pre-program" manual switches. This technique relies on the spring-loaded manual points to correctly route trains flowing into the entrance while allowing trains to come into the branches from either direction.

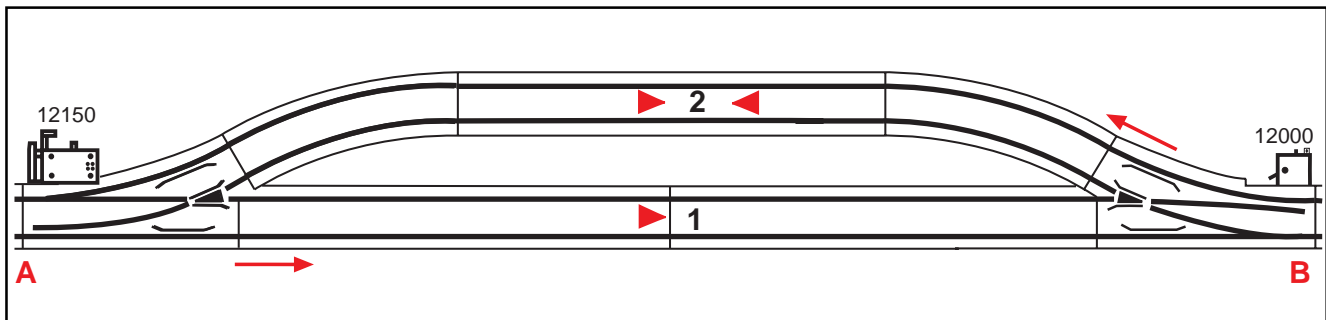

In this example, trains on both Track 1 and 2 can travel left to right through the manual switch at B. Trains on Track 1 simply push the manual points the proper direction, and the points return to their "pre-programmed" position automatically. So, when a train arrives from the right, it is automatically routed onto Track 2.

Pre-programming works when the switches are clean and well maintained. However, that may be difficult, especially outdoors, and the light tension on the points may not be sufficient to return the points to their pre-programmed position. Also, smaller cars may not have enough weight to push the points open.

Circuit 6: Automatic Directional Block

This useful little circuit has no official EPL components. It does have one electronic component, a simple diode, that will appear in several other EPL circuits with EPL components.

Hint: Most EPL circuits will work normally on Multi-Train System layouts. However, circuits with diodes connected directly to the track will not work properly on Multi-Train System layouts.

A diode is an electronic check valve. It will let current flow in one direction, but not the other. For example, it will let current flow from positive to negative, but not negative to positive. Since conventional LGB track current is DC, which is positive and negative, you can use a diode to control LGB track current.

A diode is indicated by a "▶" symbol. The triangle points in the direction current can flow.

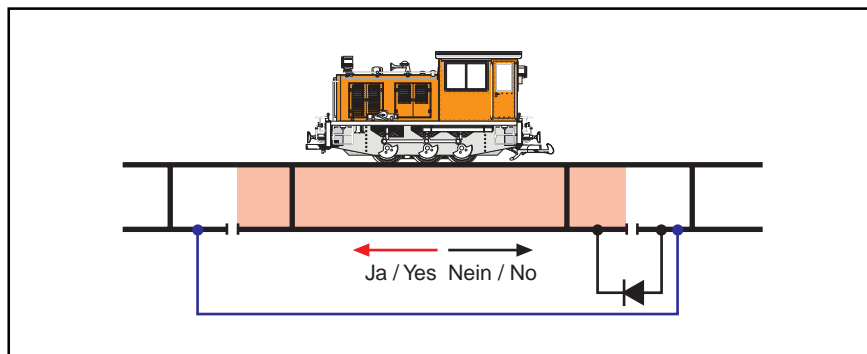
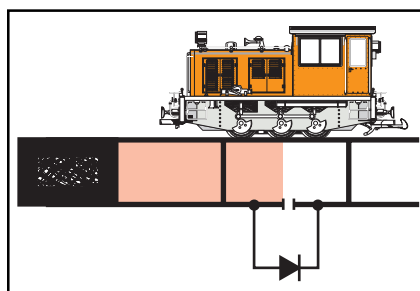
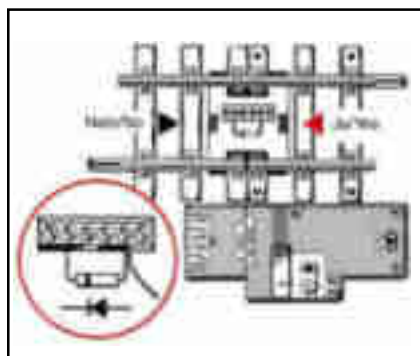

In an Automatic Directional Block (above), a diode bridges the insulated gap in a 10153 Insulated Track Section. A train can enter the block from the right and pass through the block. The diode allows current to flow into the block in that direction.

However, if a train enters from the left, it will stop inside the block. The diode prevents current from flowing in that direction. (How do you get the train out of the block? Reverse the direction with your speed control and back out.)

This circuit is often used with LGB signals (above left) to protect crossings and switches from stray traffic. Another popular use is to protect bumpers at the end of dead-end "stub" sidings (left). This helps prevent accidents when an unattended loco is accidentally shunted to the end of a siding.

Just install a 10153 on the siding before the bumper. (The distance between the bumper stop and the 10153 should be greater than the length of your locomotive.) Then connect the diode to the 2A and 2B terminals on the 10153 terminal strip.

Test the circuit by driving a locomotive towards the bumper. The locomotive should stop when it crosses the 10153. If it does not, reverse the diode connections, and test the circuit again.

Hint: What kind of diode should you use? The diode must match the output of your power supply:

Power supply output	Suggested diode type
1 amp	1N4001
2 amp	1N5400
10 amp	10ETS08 (International Rectifier)

Circuit 7: Automatic Reversing Circuit

Sometimes, you need to do more than stop a train at the end of a track. You may also need to "reverse," make it go the opposite direction. For many reversing tasks, 17100 Track Contacts can be used together with a 12030/12010 relay. In this example (below), the 17100s are mounted near the ends of a point-to-point line. When a train triggers one of the 17100s, the 12030/12010 combination reverses the track power polarity, and the train goes the opposite direction.

Hint: The 12030/12010 is not attached to a track switch. Although this relay can be used to drive a track switch, it can also be used independently and mounted in any convenient location near your layout.

If you add another 17100 and connect it to the same 12030/12010 relay, you can automate both ends of a point-to-point layout. In fact, you can add a third 17100 to automate a point-to-point-to-point layout, like the one on Page 114. ("R1" is the 12030/12010 relay used for reversing. ("R2" is a separate relay used to control the separate 12010 drive on the track switch between all three points.)

Hint: This circuit will not work properly if the train direction is changed with the power pack (or speed control with transformer). The 12030/12010 must control the track power polarity. Also, this circuit will not work with Multi-Train System layouts.

Attention: Sudden reversing can damage your trains. Use slow speeds with this circuit and monitor your trains carefully.

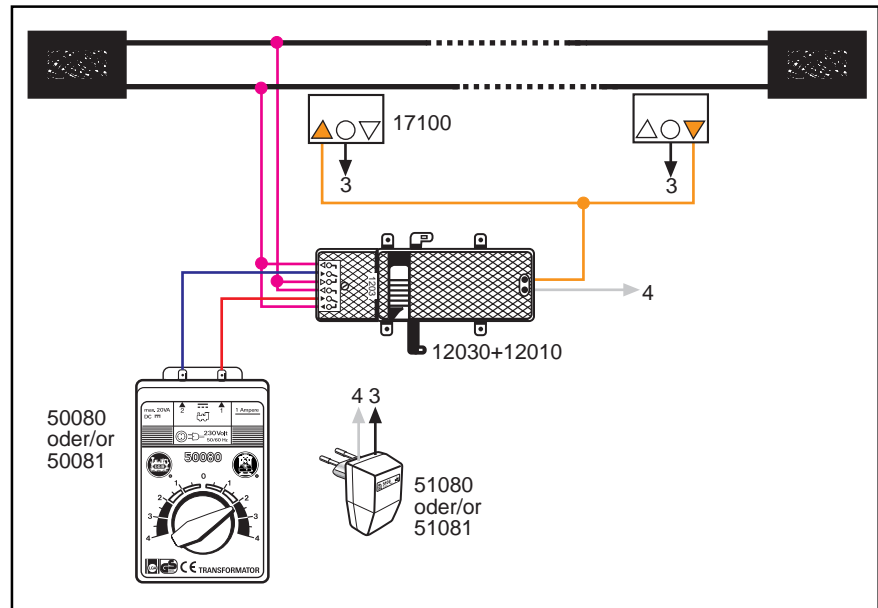

Reversing Loop Solutions

Reversing loops offer operating advantages and electrical problems. Those problems can be solved with EPL system circuits.

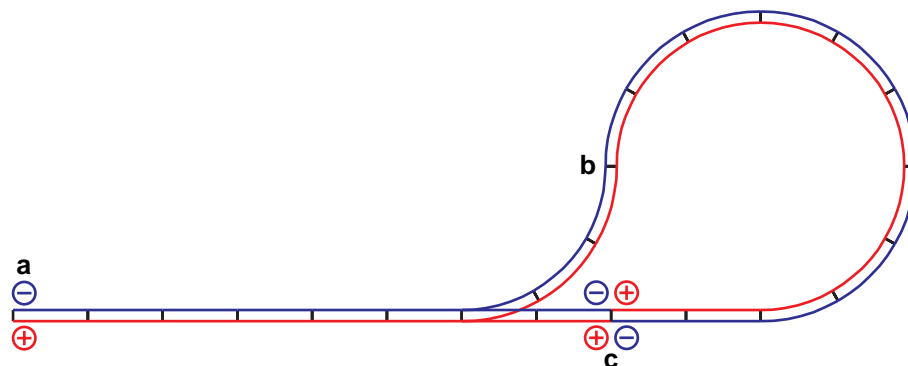

Unfortunately, reversing loops create electrical problems because the reversed rails cause short circuits. You can see this if you trace the rails of the layout here. Start your finger on the negative (-) rail at Point A. Follow the rail through the switch to Point B until you reach Point C...where you run directly into the positive (+) rail. Now you have a short circuit!

So why use reversing loops? They offer many advantages for realistic and convenient train operation. For example, two reversing loops combined offer continuous operation with a single track connecting the loops. You get the flexibility of a point-to-point layout with the ease of an oval layout.

The EPL system can be used in many different ways to solve the electrical problems caused by reversing loops. In the next three circuits we will show you some of the best solutions.

Circuit 8: Manual K/T Reversing Loop



The 10151 Reverse Loop Track Set may be the most ingenious item in the entire EPL system. The 10151 set makes it possible to wire a simple reversing loop without any wire at all.

This special set includes two 150 mm straight sections, commonly known as the "1015T" and the "1015K" because of their old names in the pre-1993 LGB numbering system.

The 1015T is a standard 10152 Insulated Track Section. The 1015K, however, is special. Under the center cover of the 1015K, you will find four diodes on a circuit board. These diodes ensure that the track polarity between the 1015T and 1015K is always the same, no matter what the polarity is outside the T/K section.

Because of this, trains can only travel one direction between the 1015T and 1015K, that is, from the "T" to the "K." That direction is indicated by a large arrow on the cover of the 1015K.

Typically, the 1015T is installed just beyond the entrance of a reversing loop. The 1015K is installed near the exit of the loop, with the arrow pointed at the exit.

Manual K/T Reversing Loop

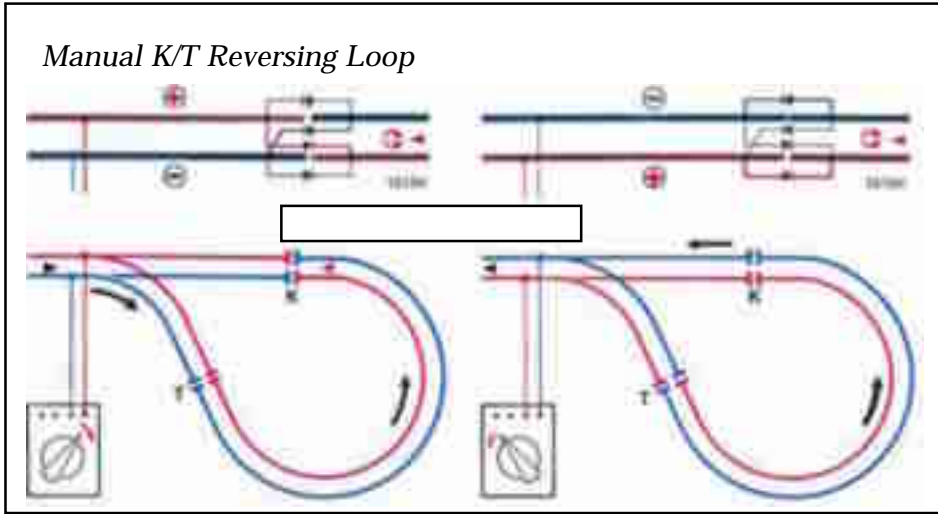

How does it work? Follow the arrows, like a train, through the loop. A train enters the loop and passes over the 1015T. Before the train reaches the 1015K, you manually reverse the throttle.

The track power polarity outside of the reversing loop will change, but because of the diodes in the 1015K, the track power polarity inside the loop will not change. The train will continue traveling in the same direction through the loop, over

the 1015K and onto the rest of the layout. The reversing loop problem has been solved.

Problems? Some trains, especially lighter trains, may shudder during a quick throttle change. That problem can be addressed by hiding the change point (e.g., with a tunnel) or by installing a stopping point (e.g. a road crossing) where the change can be made as part of a natural railroad operation.

Also, trains operating between the 1015T and 1015K can only move in one direction. So stations and sidings should usually be located outside of the T/K controlled area, as in this example of a large reversing loop with a station and switching yard.

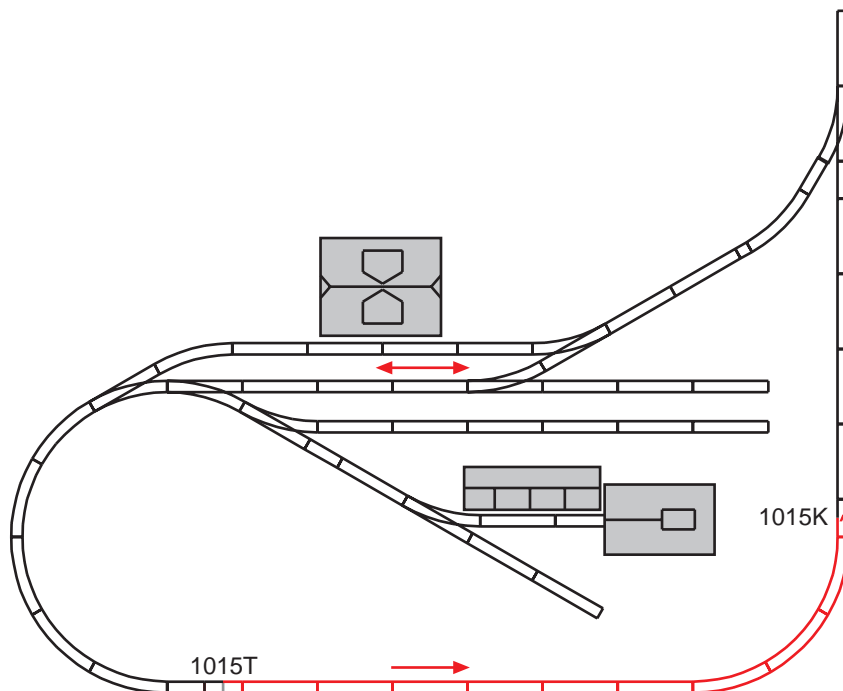

Hint: Remember the rule concerning "electrical length" (see Page 109). For any circuit with an isolated track block to work properly, your trains must be electrically shorter than the length of the isolated track block. When you design a K/T circuit, make sure the distance between the 1015T and 1015K is long enough for your trains.

Also remember that metal wheels can bridge the insulated rail gaps and cause a short circuit, whether they are wired for electrical pickup or not.

Circuit 9: Automatic K/T Reversing Loop

By combining the Automatic Reversing Circuit (Circuit 7) and the Manual K/T Reversing Loop (Circuit 8), you can create a new circuit (left) to automate the throttle reversing procedure required by the Manual K/T Reversing Loop. Instead of installing the 17100 Track Contact near a bumper, the contact is mounted somewhere between the 1015T and the 1015K, usually near the 1015K.

Instead of installing the 17100 Track Contact near a bumper, the contact is mounted somewhere between the 1015T and the 1015K, usually near the 1015K.

Hint: The 12010/12030 relay here only controls the polarity of the circuit. You can use a pre-programmed manual switch to make sure the train always enters the loop in the correct direction.

This circuit can also be used to automate two K/T reversing loops in a loop-to-loop layout. Only one additional 17100 is required, and a track of any length can be installed between the loops.

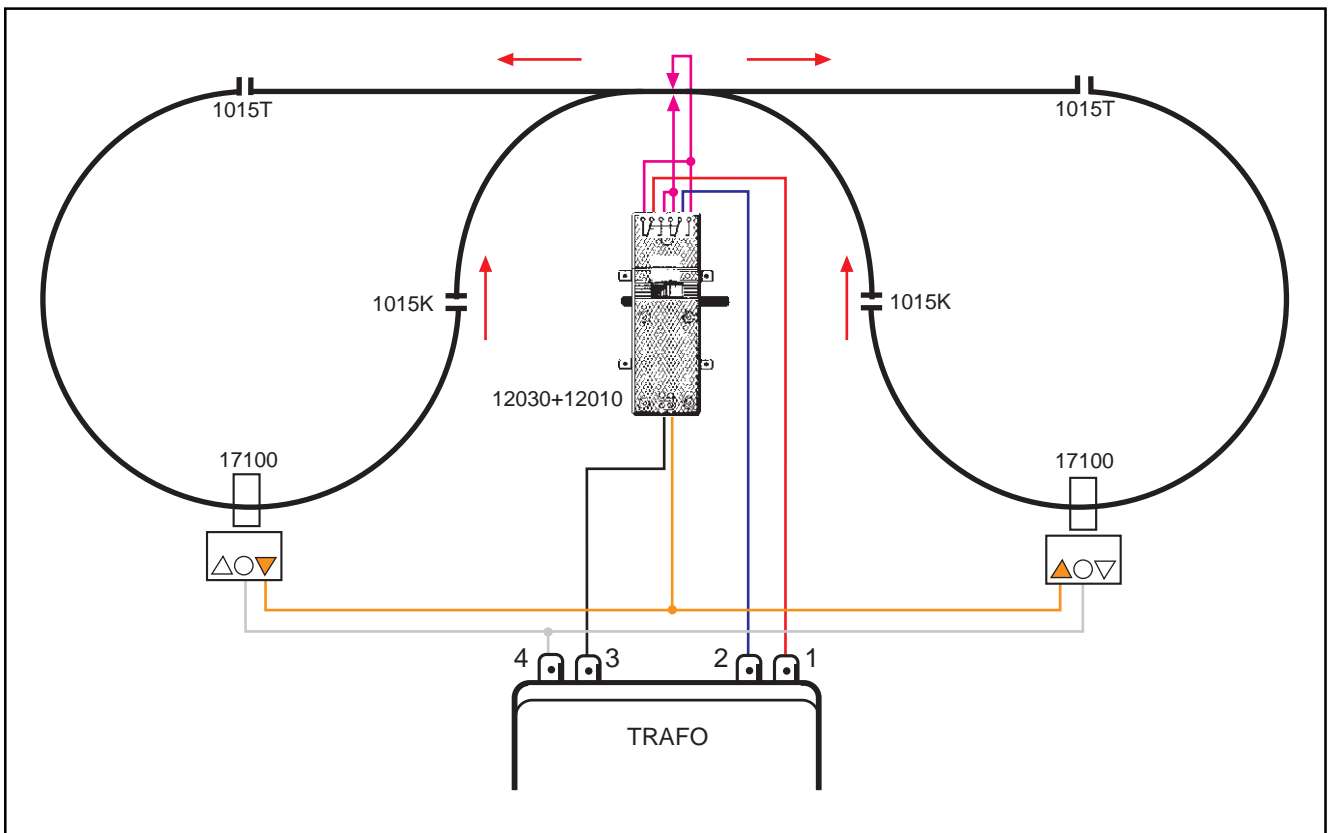
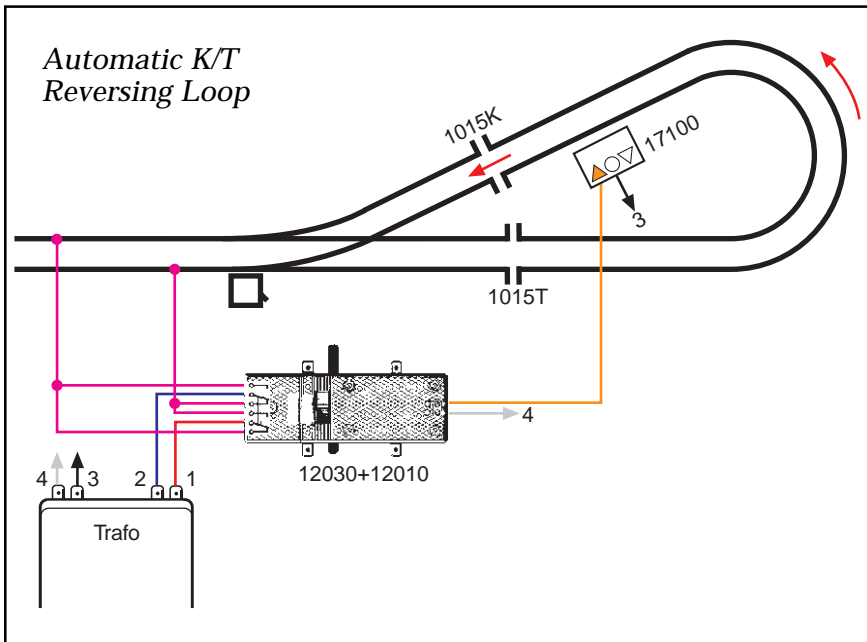

If you want to build a long layout along a wall or fence, like the Danish reversing loop layout diagrammed here, an automatic K/T circuit is one of your best choices for easy installation and realistic operation.

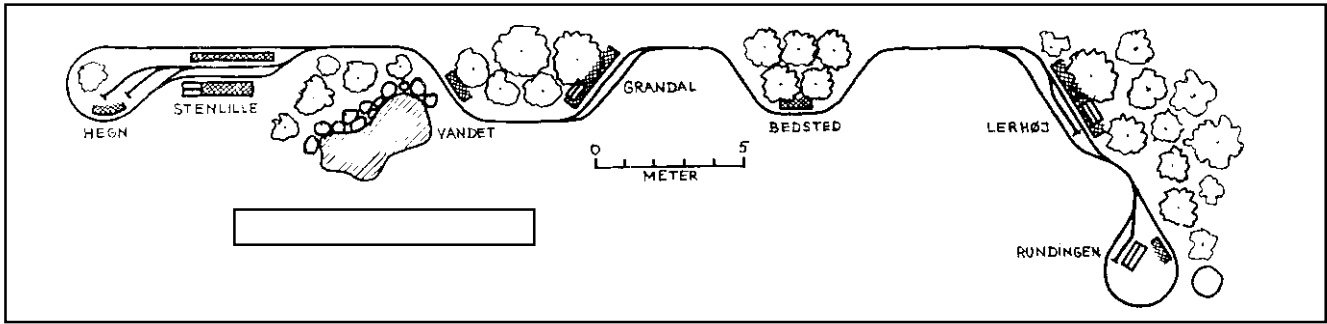

**Circuit 10:
Fully Automatic Reversing Loop**

There are two potential drawbacks to the two earlier reversing loop circuits. First, they only allow one-way travel through the loop. Second, because they include diodes, they cannot be used with the Multi-Train System.

This circuit solves both of those problems. You can use this circuit on a Multi-Train System Layout, and you can move in either direction inside the loop.

Plus, you can enter the loop in either direction. As wired here, that direction is determined automatically by the 12030/12010 attached to the track switch. You can manually control the direction by connecting a 51750 Momentary Control Box to the 12010.

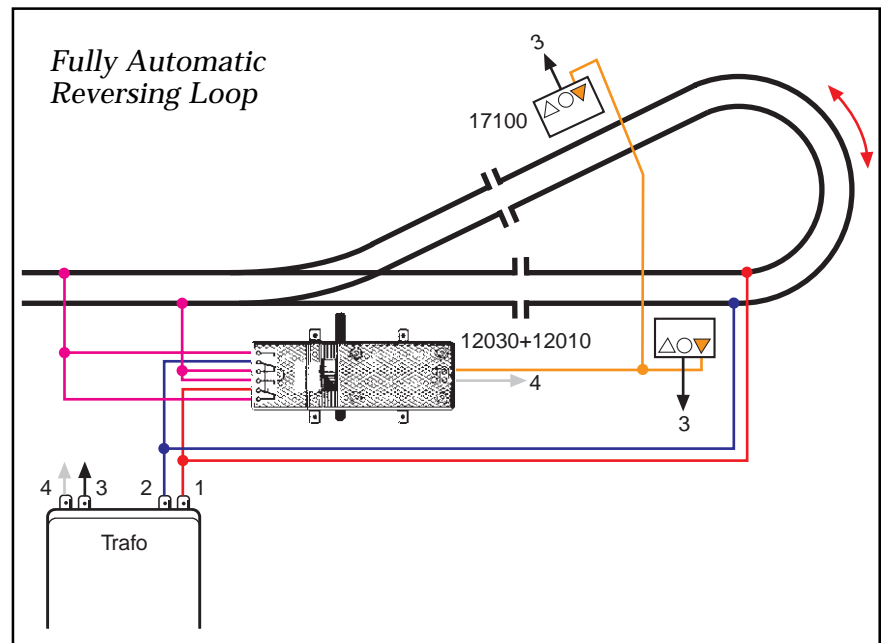

Variations on a Theme

Reversing loops don't always look like loops. Sometimes, they look innocent, like this oval with a crossover track, and sometimes, they look complicated, like the classic "wye" (below). But the wiring problems they pose can be solved with the same kinds of circuits.

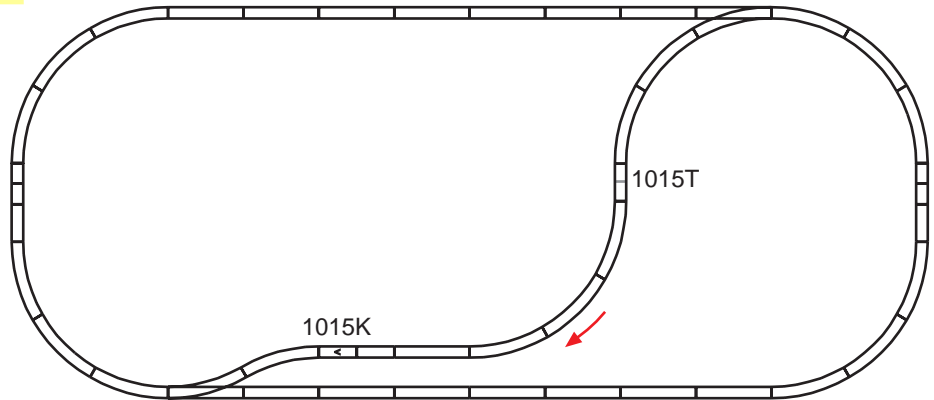

For example, both of these layouts can be rigged with a "T/K" circuit, either manual (Circuit 8) or automatic (Circuit 9), with the the 1015T and 1015K installed in one leg of the wye.

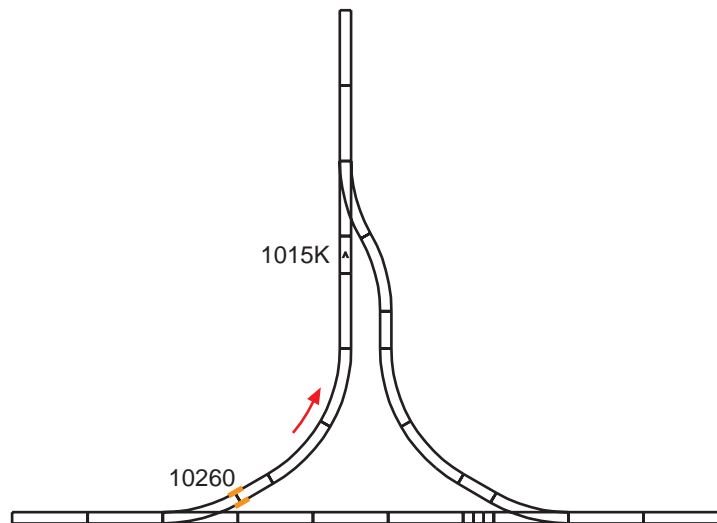

Hint: The "1015T" in the Reverse Loop Set is a standard 10152, and for convenience in layout design, it can be replaced with a 11152 Curved Insulated Track or two 10260 Insulated Rail Joiners.

Lang Garden Bahn: Easy Living Layout

Heidi and Paul had a lot of fun running a lot of trains with all their friends at their big layout party, but sometimes, you have to relax. So after the family recovered from the party, they bought a few EPL components and wired their station area with Circuit 5, the "Alternating Station Circuit."

The circuit uses just two 17100 Track Contacts to control one 12010/12030 relay at the entrance of the station. The wiring is simple, and since Paul used the "floating" track laying technique, it was easy to lift the track out of the ballast and install the insulated joiners.

With the Alternating Station Circuit, two trains can run unattended on the layout at the same time. One train leaves the station, circles the layout and returns. Then the other train leaves the station and returns. It's all automatic.

There's really nothing for Heidi and Paul to do...except fall asleep in the hammock together.





CHAPTER 10: FORM AND FUNCTION

LGB signals offer realistic appearance and automatic operation.

In many LGB products, the craftsmen at Ernst Paul Lehmann Patentwerk have combined form and function. For example, LGB signals add beautiful splashes of color and motion to any layout, and they can also help you control your trains and avoid accidents.

What are Signals?

Signals are traffic lights for trains. Signals tell an engineer whether his train should "Stop," "Go" or "Proceed Slowly."

Unlike highway traffic lights, railroad signals are not standardized. Some use lights, some use signal arms and some use a combination of lights and signal arms.

Also, because of the long distances required to stop trains, there are two different basic types of signals: "distant" signals and "home" signals. In Germany, a distant signal is called a "Vorsignal" (Vr). A home signal is called a "Hauptsignale" (Hp). For consistency with other LGB instructions, we will use those abbreviations along with these codes for signal indications:

Code Indication

Vr0	Stop Signal Ahead
Vr1	Go Signal Ahead
Hp0	Stop
Hp1	Go
Hp2	Proceed Slowly

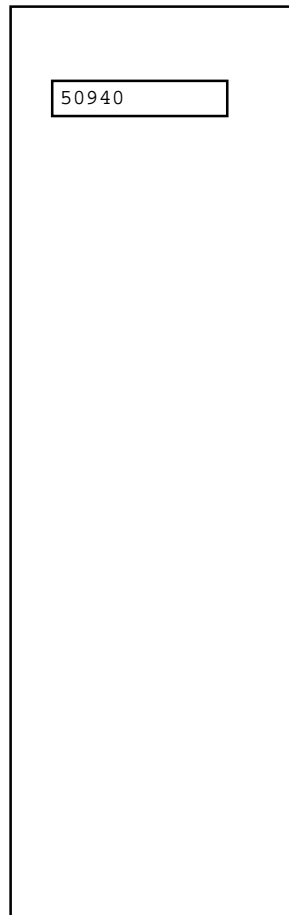
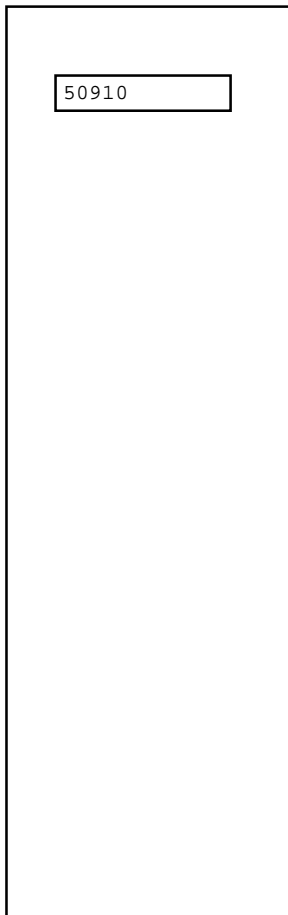

EPL Signals

There are five electric signals in the LGB EPL system:

- **50910 European Vr0/Vr1 Signal.** This is a distant signal. Instead of a signal arm, it has a distinctive yellow disk that flips from vertical to horizontal. This signal is usually used together with one of the European-style home signals.

- **50920 European Hp0/Hp1 Signal.** This is a single-arm home signal. For European-style layouts, this "Stop/Go" indicator is the most common signal.

- **50940 European Hp0/Hp2 Signal.** This is a double-arm home signal. It is the only EPL signal with the Hp2 "Proceed Slowly" indicator. It is often **used to control traffic moving from a siding onto the main line.**

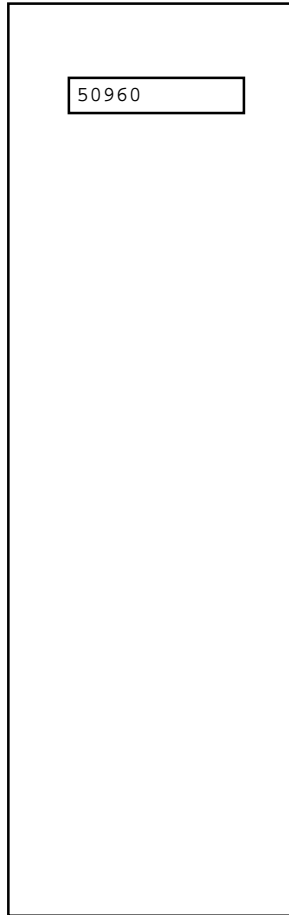
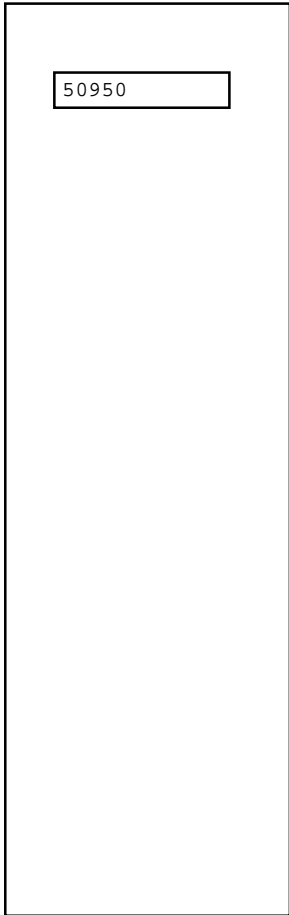

• **50950 RhB Lighted Signal.** This Hp0/Hp1 (Stop/Go) signal has no arms, only red and green lights. It is modeled after signals on Switzerland's Rhätische Bahn.

• **50960 U.S. Semaphore Signal.** This Hp0/Hp1 (Stop/Go) signal has a classic American semaphore arm.

Hint: The LGB program also includes the hand-operated 50300 Manual Semaphore Signal.

Except for the 50910, these EPL signals also include:

- an EPL signal drive. This drive is similar to a 12010 switch drive, and it can be controlled with a 51750 control box or a 17100 track contact, just like a 12010. However, the signal drive has a special socket to hold the signal mast. The signal drive also has power terminals (AC, DC or Digital AC) for the signal lights.

- a 12030 Supplemental Switch. The 12030 is attached to the signal drive at the factory, and together, they function just like a 12030/12010 relay for train control circuits.

- two 10152 insulated track sections. These are used to create isolated track blocks. These sections have slots to attach an EPL signal drive. The signal drive can be moved in the slots to provide extra clearance for wide cars. Also, the signal drive can be mounted away from track (e.g., on curves).

- a diode. This diode is included for special directional signal circuits.

Since the 50910 distant signal is usually used with a home signal, it includes a signal drive, but it does not include a 12030 Supplemental Switch. It is equipped with one track section for mounting.

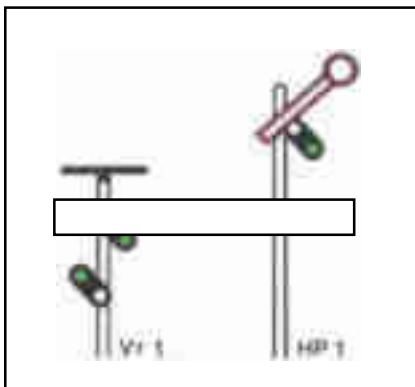

Here, a "distant" 50910 signal (left) indicates "Go Signal Ahead" (Vr1). The "home" 50920 signal (right) indicates "Go" (Hp1).

At first, it may be hard to understand what each signal indicates. But the code is easy to crack:

Signal	Code	Indication	Lights	Arm Position
--------	------	------------	--------	--------------

Distant Signal

50910	Vr0	Stop Signal Ahead	Red	Disk vertical
	Vr1	Go Signal Ahead	Green	Disk horizontal

Home Signals

50920	Hp0	Stop	Red	Arm horizontal
	Hp1	Go	Green	Arm up 45°

50940	Hp0	Stop	Red	One arm horizontal, one arm vertical
	Hp2	Proceed Slowly	Yellow	Both arms up 45°

50950	Hp0	Stop	Red	
	Hp1	Go	Green	

50960	Hp0	Stop	Red	Arm horizontal
	Hp1	Go	Green	Arm down 45°



Circuit 12: Manual Signal Block

This simple signal circuit demonstrates the basic principles behind every EPL signal circuit.

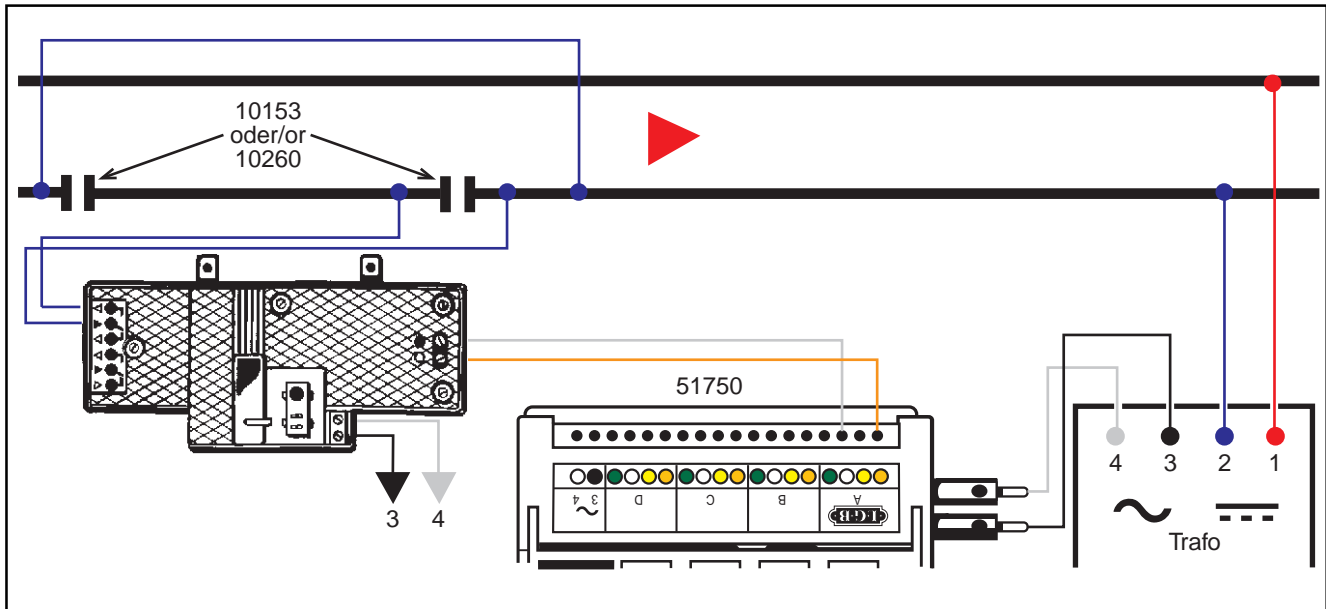

Use the two insulated track sections included with the signal to create an isolated track block. (Remember, for any circuit with an isolated track block to work properly, your trains must be electrically shorter than the length of the isolated track block.)

Attach the signal drive to the insulated track section at the exit of the block, and wire the 12030 to the terminals on that section. Connect the lighting terminals on the signal drive to an AC power source.

The signal is controlled with a 51750 Momentary Control Box. Press the top of the appropriate 51750 button, and the signal indicates "Go" (Hp1). The 12030 connects power to the isolated block, and trains can move through the block.

Press the bottom of the button, and the signal indicates "Stop" (Hp0). The 12030 disconnects power to the isolated block, and trains cannot move through the block.

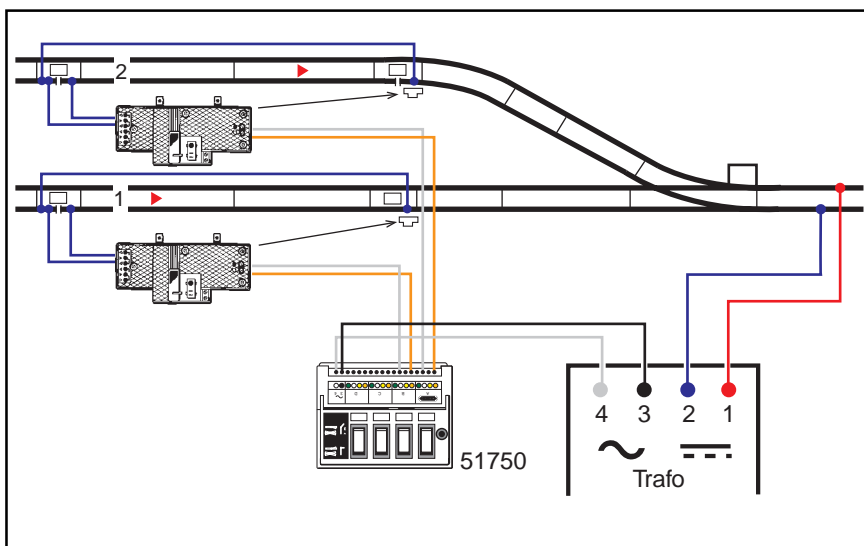

Of course, this circuit can be duplicated as often as needed. In this example (below), departures from two sidings are controlled with two signals, an Hp0/Hp1 on the lower track and an Hp0/Hp2 on the upper track. The "proceed slowly" (Hp2) signal is used on the upper track to remind the engineer to move cautiously through the switch onto the main line.

**Circuit 13:
Semi-Automatic Signal Block**

On a real railroad, our manual signal block would be considered dangerous. Why? Because it relies on fallible humans to set the signal properly.

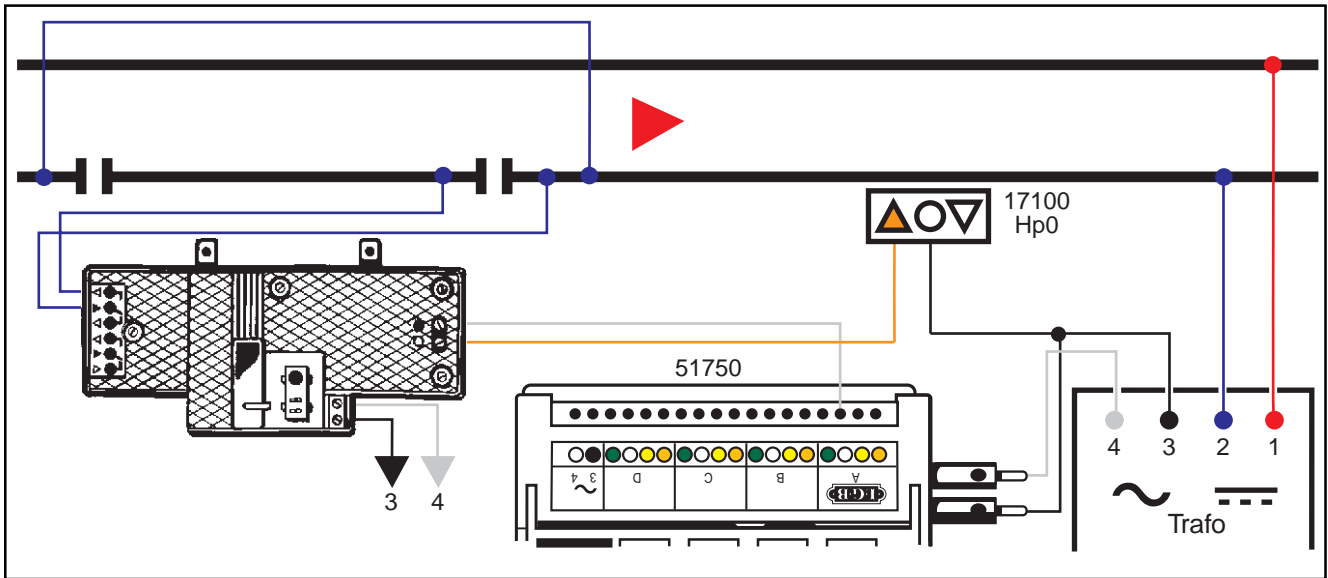

The EPL system offers an easy, but partial, solution. Just add a 17100 Track Contact to the circuit. Install the 17100 in the track after the exit of the block. Once a train passes through the block, it crosses over the 17100 and automatically switches the signal back to "Stop" (Hp0). That prevents another train from accidentally passing through the block until the operator manually sets the signal to "Go" (Hp1).

**Circuit 14:
Automatic Signal Blocks**

Of course, we can make our signal-controlled railway even safer by eliminating the human factor completely. With this fully automatic circuit, you can run two, three or more trains at the same time without any fear of collision.

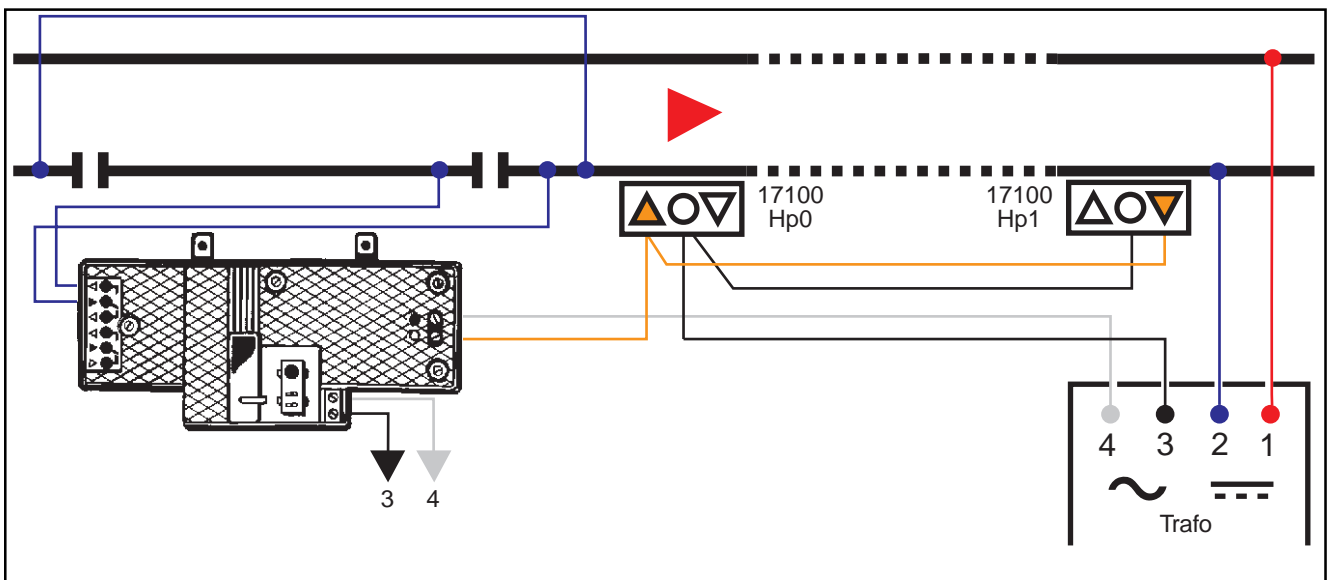

The number of trains you want to run determines the number of Automatic Signal Blocks you need. You always need one more block than the number of trains you want to run. In this example, we want to run two trains, and so, we need three blocks.

The block circuits are very similar to the Semi-Automatic Signal Block. As before, the circuit uses one 17100 for automatic "Stop" (Hp0) control. However, there is no 51750 for manual "Go" (Hp1) control. Instead, there is an additional 17100.

Here's the trick: The "Stop" 17100 is installed after the exit of the block, just like before, but the "Go" 17100 is installed near the entrance of the block two blocks ahead.

When a train leaves a block it disconnects power from the block immediately behind it. When that train reaches the entrance of the next block, it connects power to the block two blocks ahead, releasing the train stopped in that block. This arrangement keeps the trains moving from block to block, with one "Stop" block between them at all times.

This circuit is relatively simple to build, impressive to watch and easy to operate. The only special consideration is that the distances between the blocks should be at least one train length.

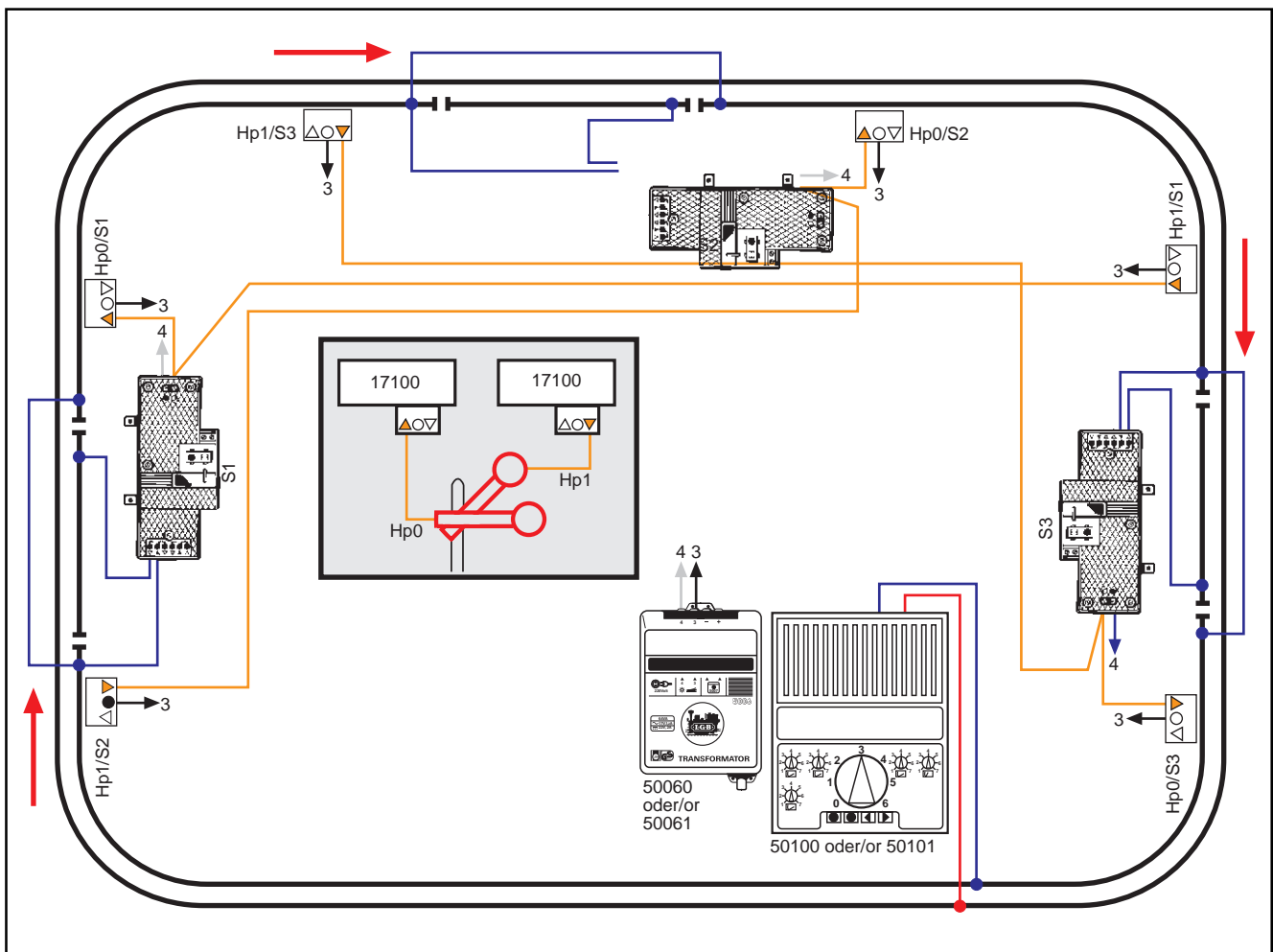

Circuit 15: Distant-Home Signal Combination

The 50910 "distant" signal can be added to almost any signal circuit. The distant signal only functions as a warning to the engineer that a mandatory "home" signal is ahead. So the 50910 has no train control functions (and no 12030 Supplementary Switch).

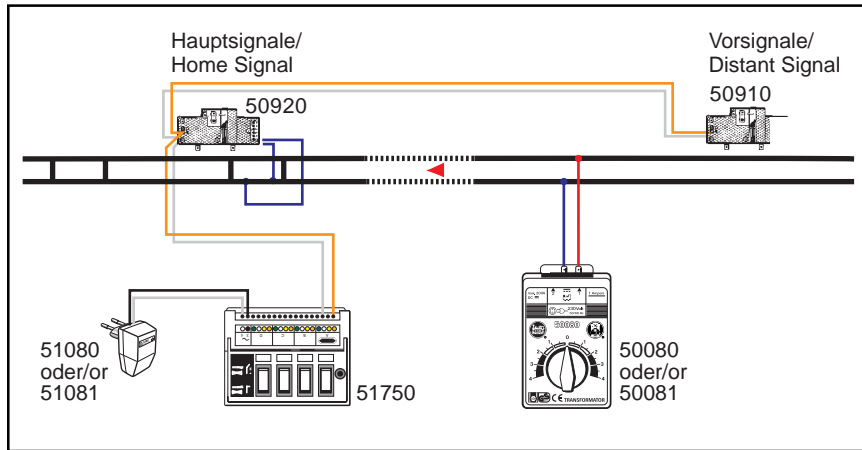

The circuit is simple. Connect the orange and white terminals on the 50910 to the orange and white terminals on the "home" signal. Now, the distant and home signals work together at the same time with the same control signals from a 51750. If you wish, also connect the lighting terminals on the 50910 to an AC or DC power source (12-18 V).

On a prototype railroad, the gap between the distant signal and the home signal is usually at least 400 meters. In G-scale, that's almost 18 meters (400/22.5) and far too long for a credible visual effect. Instead, we recommend a gap of about a train length.

Directional Signal Blocks

On a real railroad, a signal only provides instructions to trains traveling in one direction. A "Stop" (Hp0) indication for a train traveling east will not stop another train traveling west on the same track.

However, our first two signal circuits will stop traffic in both directions. As a safety measure, that might be good. However, you can make your LGB signal circuits work like real signal circuits by using the diode included with most EPL signals.

Simply install the diode between terminals "2A" and "2B" on one of the 10153 insulated track sections. Now, the signal circuit will control trains traveling in one direction. But trains traveling in the opposite direction can pass through the circuit freely.

As always, you cannot use circuits with diodes with the Multi-Train System.

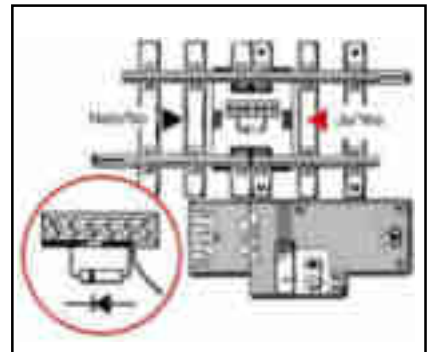

Circuit 16: Protected Crossing

EPL signals can be used to create a wide variety of "protection" circuits. In this example, a signal and two 17100 track contacts are used to protect the crossing of the main line (Track A) and a local tram line (Track B).

When the freight train on the main line approaches the crossing from the left, it passes over a "Stop" (Hp0) 17100, preventing the railbus on the tram line from entering the crossing. Once the freight train clears the crossing, it triggers a "Go" (Hp1) 17100, allowing the railbus to pass through the crossing.

This circuit only protects one-way traffic on the main line. Install a second pair of 17100s for two-way traffic.

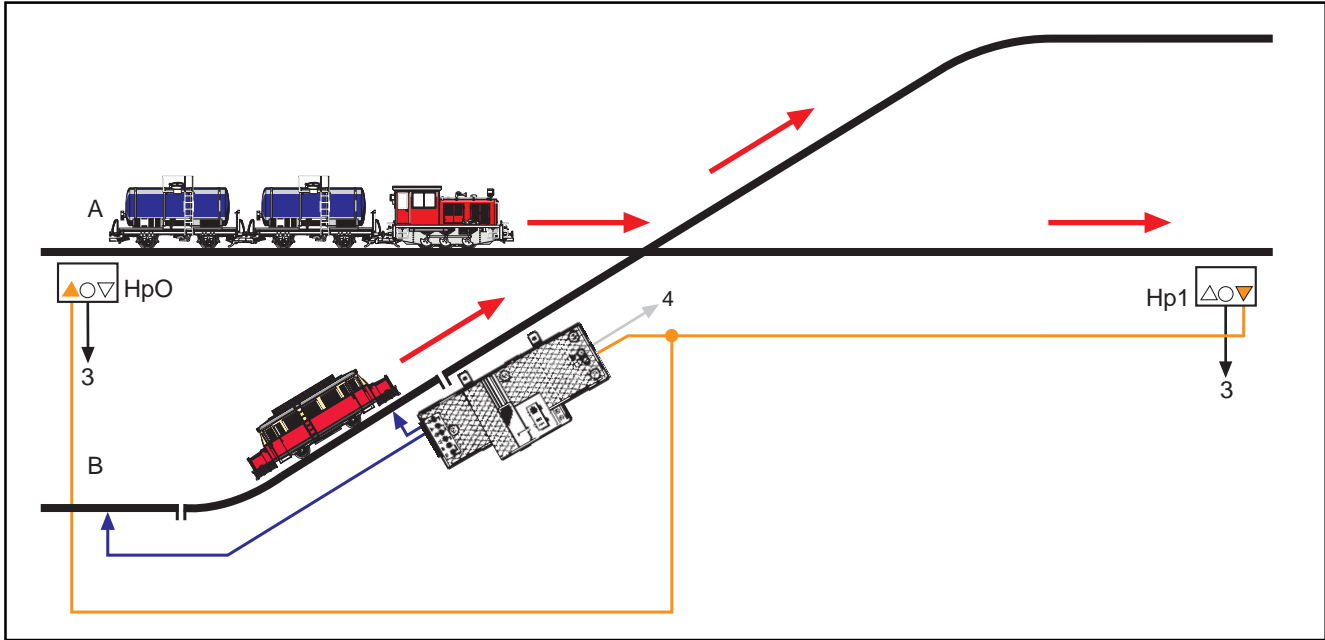

Why Use Signals?

If you understand the basic principles of EPL circuits and components, you may have already realized that you could replace the signals in these circuits with 12030/12010 relays. The circuits would function identically.

With their tall masts, flashing lights and moving arms, signals add visual appeal to your layout. Plus, they provide a quick way to verify the position of the 12010. So signals offer both form and function.

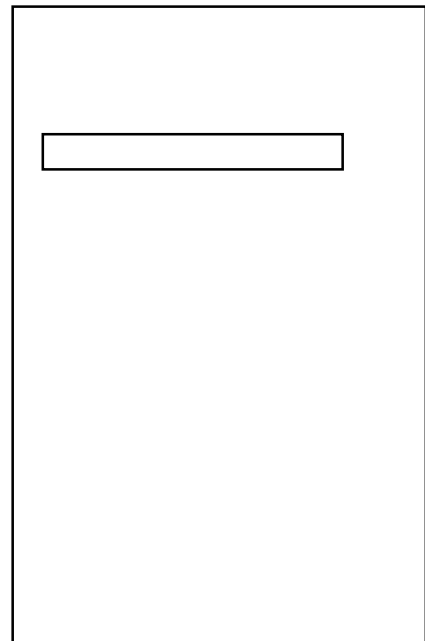

LGB Q&A

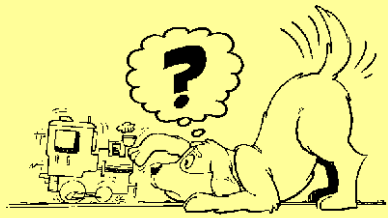

What do I need to power electric signals and switches?

To use most LGB accessories—including signals, switches, switch lanterns and street lights—you need 18 volt AC power. Some special products, like the 10560 Electric Uncoupler and the 10154 Activation Track, also need 18 volts AC.

If you have a small layout, you can use LGB's wall-mount, 0.5 amp, AC Transformer (51080 230 V, 51081 110 V). Also, the 0.5 amp power packs included in older LGB starter sets have AC terminals and can be used to power accessories.

As your layout grows, your AC power needs will increase rapidly. For reliable operation of accessories on larger layouts, we recommend a larger, dedicated AC power source, like the 2 amp "5006" AC/DC Transformer (50060 230 V, 50061 110 V) or the high-output 5 amp AC Transformer (50110 230 V, 50111 110 V).

Also, the 52750 EPL Booster can improve the performance of both switches and signals.

Here, an LGB transformer provides AC power for an EPL Booster (52750), Control Box (51750), Switch Drive (12010) and Signal (50920) with lights.

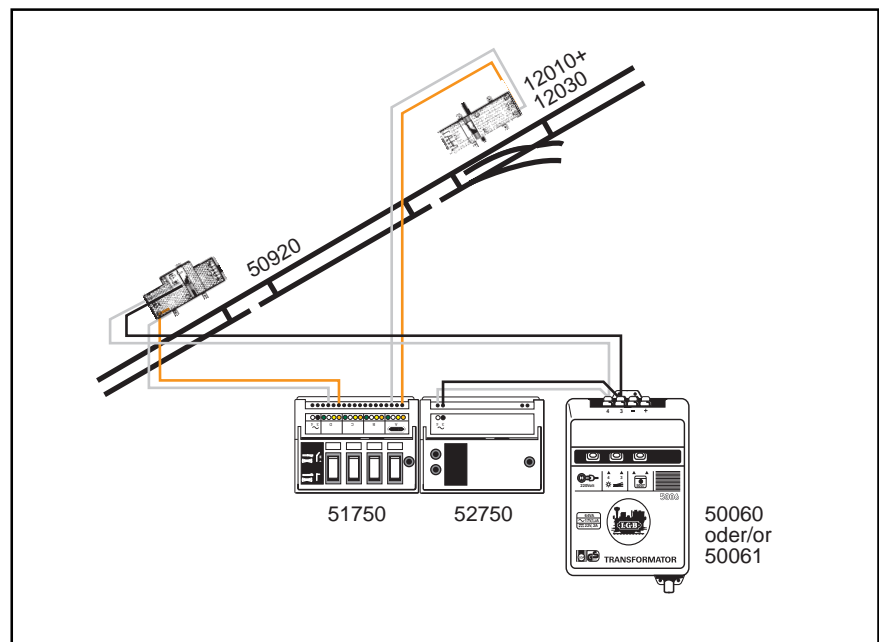

Hint: Did you notice how nice and straight the wires are in the drawings in this book? In real life, they never are. Don't worry about it.

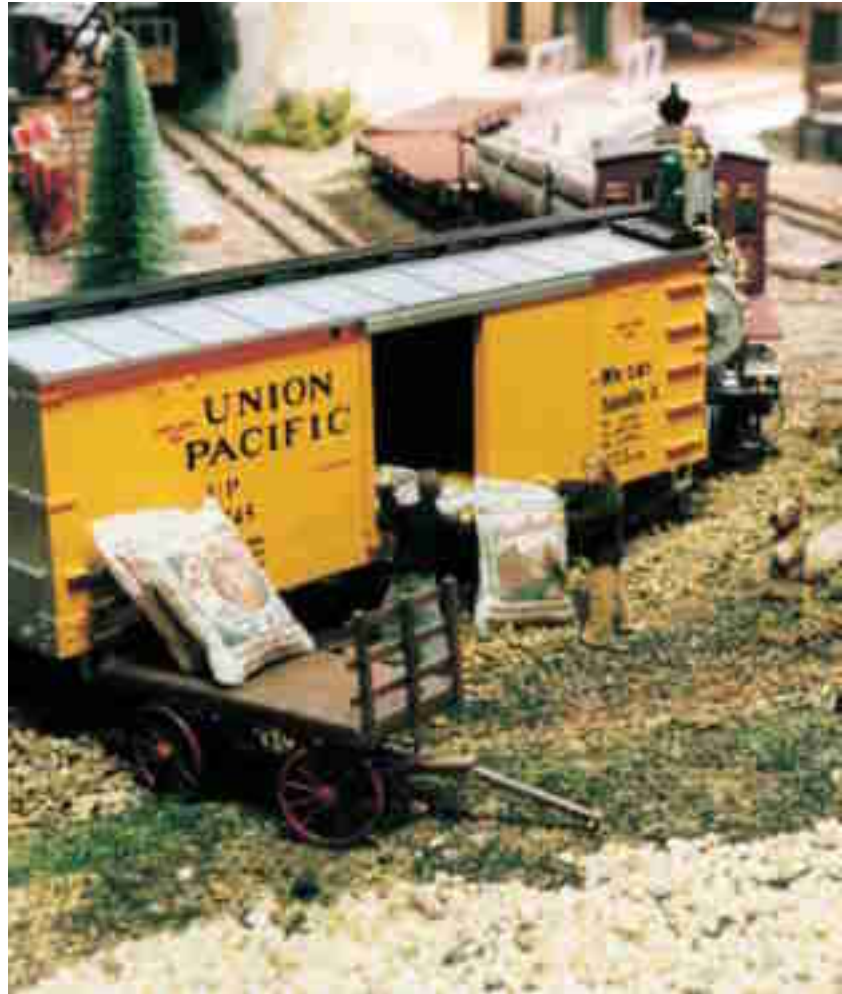

CHAPTER 11: THE START OF AN EMPIRE

*Goods are loaded on the
Chaplin layout, which
combines American and
European trains.*

By now, you've progressed far beyond the starter set circle that transported you into the World of LGB. You have all the electrical and mechanical building blocks you need to build your own LGB empire. But what should you build? What will your layout look like? This chapter will help you decide.

Design for Fun

For a few minutes, take your hand off the throttle. Stop fiddling with wiring, and put your trains away.

Now, pour your favorite beverage. Pull up a comfortable chair, and start thinking.

Of course, you don't want to think too much. Some people think about building a layout for years...and never actually build one. However, a little bit of thinking can make your layout a lot more fun. Start by asking yourself these basic design questions:

- **Will the layout be indoors or outdoors?** Although LGB is made for the outdoors, at least half of all LGB layouts are indoors. Without the environmental challenges of outdoor layouts, indoor layouts can be more complex and more realistic, at least by traditional model railroading standards.

Conversely, outdoor layouts should be simpler. Yes, you can build a ten-track freight yard outdoors, but you will spend many hours cleaning leaves and dirt out of the switches. On the other hand, nothing indoors can compare to the sight of a 20-car G-scale train snaking its way through a valley of blooming flowers illuminated by the natural light of the sun.

- **How much space is available?** G-scale trains are big, and obviously, more space is better. However, a big area isn't absolutely necessary. Space can be effectively compressed with multi-level layouts, tight radius curves and steep grades (using cog locos in extreme cases).

"Perimeter" layout designs can also be used to gain track length without a huge increase in actual layout size. A shelf layout is an obvious example of perimeter design. Other examples can be seen along fences and porch railings.

- **Do you want to watch trains or operate trains?** Model railroaders can be roughly defined as either "watchers" or "operators." Watchers like to sit back, relax and watch their trains go 'round and 'round. For watchers, a model railroad is a multi-media accessory, adding movement and sound to a scene, much as a waterfall adds movement and sound to a garden.

Operators like to be engineers. For operators, a model railroad is a replica of a real railroad. Goods must be loaded, trains must be assembled and schedules must be met.

Watchers and operators tend to appreciate different types of layouts. Watchers prefer simple layouts where trains can run continuously with little attention or maintenance. For watchers, oval layouts with a minimum of switches and crossings are best. For watchers, the EPL system is very helpful because it allows multiple trains to operate automatically.

Operators prefer complex layouts where trains can perform sophisti-



Outdoor railroading offers unique challenges...like snow!

The purpose of this railbus line is to serve passengers at a small rural station.



cated switching operations. For operators, point-to-point layouts with lots of sidings, stations and switching yards are best. For operators, the Multi-Train System is very helpful, because it allows several people to operate several trains on the same track at the same time.

Of course, there is not an absolute division between watchers and operators, and in reality, most LGB fans are somewhere in between the two extremes. You might want to be a watcher one day and an operator the next. Design a layout that suits your preferences.

- **What is the purpose of the railroad?** Even if you are a watcher, it is helpful to give your railroad a purpose, an imaginary place and reason to exist. For example, your railroad might exist to transport skiers from a city to a mountain resort. Your railroad might exist to transport logs from a forest to a sawmill.

Your layout can have more than one purpose—or "theme"—and you don't have to adhere strictly to any one theme. However, choosing a purpose can make later decisions about track plans, scenery and rolling stock much easier. Plus, having a purpose will give your layout a more consistent—and more appealing—appearance.

- **How will people see the layout?** In track plan books, you look at layouts from directly overhead. You can see everything all at once. In real life, that's not usually possible or even desirable.

Plan your layout so that it looks good—that is, the way you want it to look—from typical viewpoints around the layout. For example, if the layout is in your back yard, what will it look like from your back porch? If the layout is in your basement, how low should it be so your kids can see it?

- **What is the environment around the layout?** If there are trees around the layout, will leaves fall in the track? If it rains on the layout, where will the water go? (The failure to adequately plan for storm water runoff could be the Number One mistake made by first-time garden railway builders.)

Indoors and outdoors, you must plan for foot traffic, that is, people walking around—and through—your layout. The addition of a few stepping stones can save a tremendous amount of accidental damage to your track and trains.

- **How will you maintain the layout?** Make sure you can reach every single point on your layout after the layout is finished. If you create an

inaccessible area, Murphy's Law dictates that your trains will always derail in that area. This rule is especially important for tunnels. If you cannot reach every point inside a tunnel, the tunnel is too long.

For outdoor layouts, track cleaning is a special maintenance consideration. While indoor track can go for years without cleaning, outdoor track may need to be cleaned seasonally, monthly or even weekly, depending on your climate. Can you easily reach every section of track with a hand-held track cleaning tool? If not, change the layout or purchase a track cleaning locomotive.



How will people look at your layout? From above?

A brick walkway allows guests to enjoy the Grund layout, which models the famous Landwasser Viaduct of the Rhätische Bahn.



Ponds and other water features are attractive, but high maintenance.



Also, train storage is an issue for outdoor layouts. Some LGB fans leave their trains outdoors all year long, but most people prefer secure storage for their valuable trains. You could carry your trains indoors whenever you are not running them, but a better solution is to run a special storage track from outdoors into your home or basement. Another solution is to build an outdoor storage shed. Indeed, that shed could do double duty as a "control tower."

Indoor train storage makes it easy to have fun with your outdoor layout.



- **When will the layout be finished?** No, the factory is not going to send someone to break your legs if you don't finish your layout on time. However, setting a finishing date is a good incentive to get started. In fact, you could tie the finishing date to a public event, like a birthday party or club visit, at your home. That event will motivate you to turn those mounds of dirt into tunnels and mountains before the crowds arrive. Of course, no layout is ever really finished, and that brings us to our final question...
- **Can you expand the layout?** As you build your layout, you will learn more about layout building...and about what you want to build. So don't frustrate yourself by trying to build a monster layout immediately. Leave room for expansion. If you design a control panel, allow space for an extra control box. When you shop for a power pack, look at a bigger one than you need now. When you install wires, put in some extra pairs. All of these things will make it easier to make your LGB empire even bigger.

Thoughts On Track

The "Big Trains Group" is one of several Internet-based discussion groups dedicated to LGB and other large-scale trains. Members of the Big Trains Group include some of the world's most experienced LGB modelers, and we asked the members to share their thoughts on layout design. Here are a few:

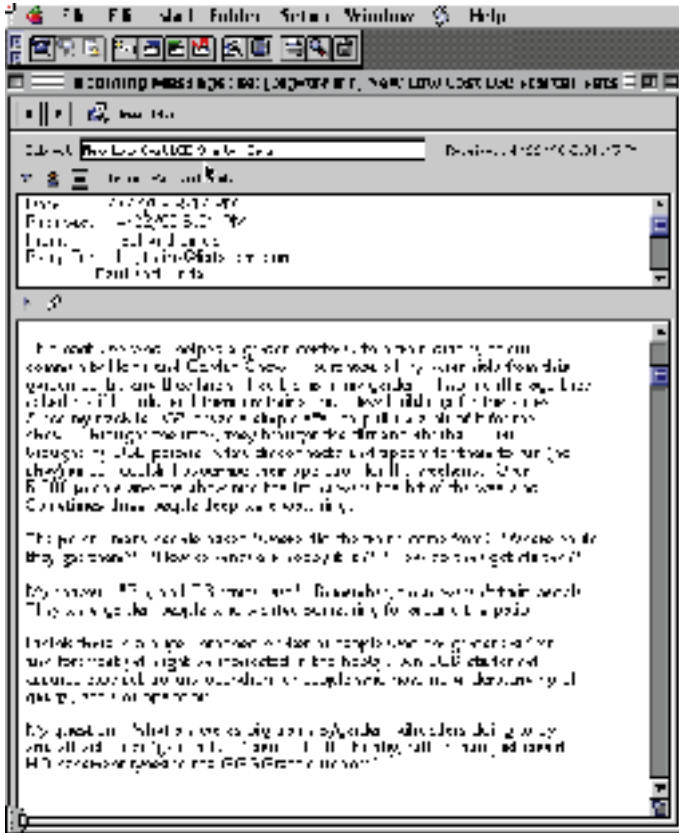

Empty space is one of the secrets of great garden railroads. Planning detailed "scenes" with empty space between them (a run of track where nothing is emphasized) gives the illusion that the entire layout is detailed. You can also set up a "visual rhythm" for a trip around your layout using busy/empty spaces like notes with the silences between them.

R. Blanchard

A whole mess of tracks (as we might say in the U.S. South) actually can defeat your efforts to create a convincing illusion. This is certainly true of many HO layouts, and because we often have plenty of room outside, the tendency might be to go hog wild!

Rick's musical analogy is appropriate. I studied music composition seriously once upon a time and still dabble a bit. Humans want to fill empty space, be it a page of a score or a piece of benchwork or a backyard. On my nearly 400 foot (120 meter) mainline loop. However, I allowed for long stretches of single track between my settlements. This gives the impression of actually moving over the road, of crossing some distance between towns.

R.L. Kinnamon

When you have drawn out your oval or circle of track and put in your first point, lead the spur track off at a diagonal. See how much more interesting the shape is?

Put disparate elements of your track plan like discrete way stations and industries—even whole rail yards—on the diagonal to break up the square shape of the layout. It looks great from down at rail level to see the buildings all at different angles and the trains appearing and disappearing through them.

R. Stein

My favorite role model, Duane Somers, built a simple but really effective layout by depositing a berm—a mound about 2 foot high and about 30 foot long -- and running an oval around it. He also has switches and sidings and such, but the berm acts like a wall, on both sides of which he has "painted" different scenes. The trains disappear and reappear behind the berm. You walk around the mound and see a different scene appear.

V. Bass

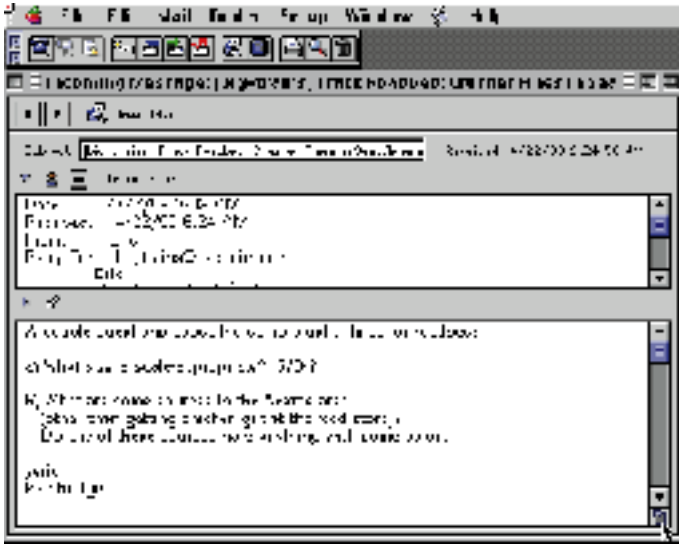

You can find answers to your layout questions on Internet-based discussion groups, like the Big Trains Group.

I recently put a flatcar on the front of my living room train, mounted a video camera on the car and subsequently sent an old HO buddy of mine the tape, to which he responded that he really enjoyed the neck jolts during the abrupt curves to get around the end tables.

The moral here is to use a transitional curve leading into the 1100 (R1) curved track sections, if one must use them at all due to space limitations. A single section of 1500 (R2) or 1600 (R3) curves leading into and out of the 1100 series curve will do wonders for the appearance of any layout, and allow the G-scale passengers to remain seated throughout the trip.

D. Doggett

Be mindful of what will happen as plants grow and spread out. Don't plant a tree too close to

the tracks or a building. Plan for drip watering, and install it first. (No, I didn't do this, and I was very sorry!)

Someone will have to climb around the layout to prune trees, replant groundcover, adjust watering, fix buildings and track, etc. Make access easy and without risk to damaging buildings, etc. Run PVC pipe underground around the layout for wiring—it's cheap. You'll be glad you did when you add a switch and need to run a few more wires. (No, I didn't do this either, darn!)

R. Turner

Our garden is small, even by English standards. I felt it did not ideally lend itself to a garden railway because it slopes steeply. At the back of the house (facing west), there is a level patio, and at the side of the house (facing south), there is a triangular area of yard.

Neither area was big enough to support a good-sized layout and reengineering the sloping garden was not something we wished to contemplate. I designed two layouts using CADDRail but liked neither. Then I hit on the answer: Build BOTH layouts and join them together with a long grade.

T. Polson

My garden is so small that there are really only two comfortable spots for viewing: the entrance and a bench along one wall. I've designed it so the view from the entrance suggests a faraway horizon (through forced perspective), while the view from the bench includes a number of separate "scenes" in closeup. From the first vantage point the train comes from and later disappears into the distance. From the second vantage point the train passes close at hand, but always in short glimpses.

S. Osterweil



Point-to-Point Layouts

Real railroads don't run in circles. Instead, real railroads travel from station-to-station or "point-to-point." A train leaves one station, crosses the land and arrives at another station. If the station is at the end of the line, the train is reversed, usually by moving the locomotive from one end of the train to the other.

These point-to-point layouts are made to replicate those realistic operations and are perfect for model railroad "operators."

This is a classic point-to-point model railway. Trains leave Station A, travel to Station B and return. It is designed for basic switching operations. Say a train arrives on Track 5 at Station A. An uncoupler, indicated with a bar in the track, uncouples the locomotive from the front of the train. Another locomotive waiting on Track 6 is coupled to the train and takes the train to Station B.

The train enters Station B on Track 1. An uncoupler uncouples the locomotive from the front of the train. The locomotive comes around the train on Track 2 and is coupled to the back of the train. Then, the train returns to Station A.

The entire process can be repeated with additional locos parked on Track 7 and in the engine shed on Track 8.

Hint: "Watchers" would quickly tire of this layout because of all the operations required to keep the train running. However, this layout can be made more appealing for watchers by replacing the cross over in the center with a 12260 Double-Slip Switch. Then trains could run continuously on the center "oval." (The 22.5° 12260 is not an exact replacement for the 30° 13000, and some make-up sections would be required.)

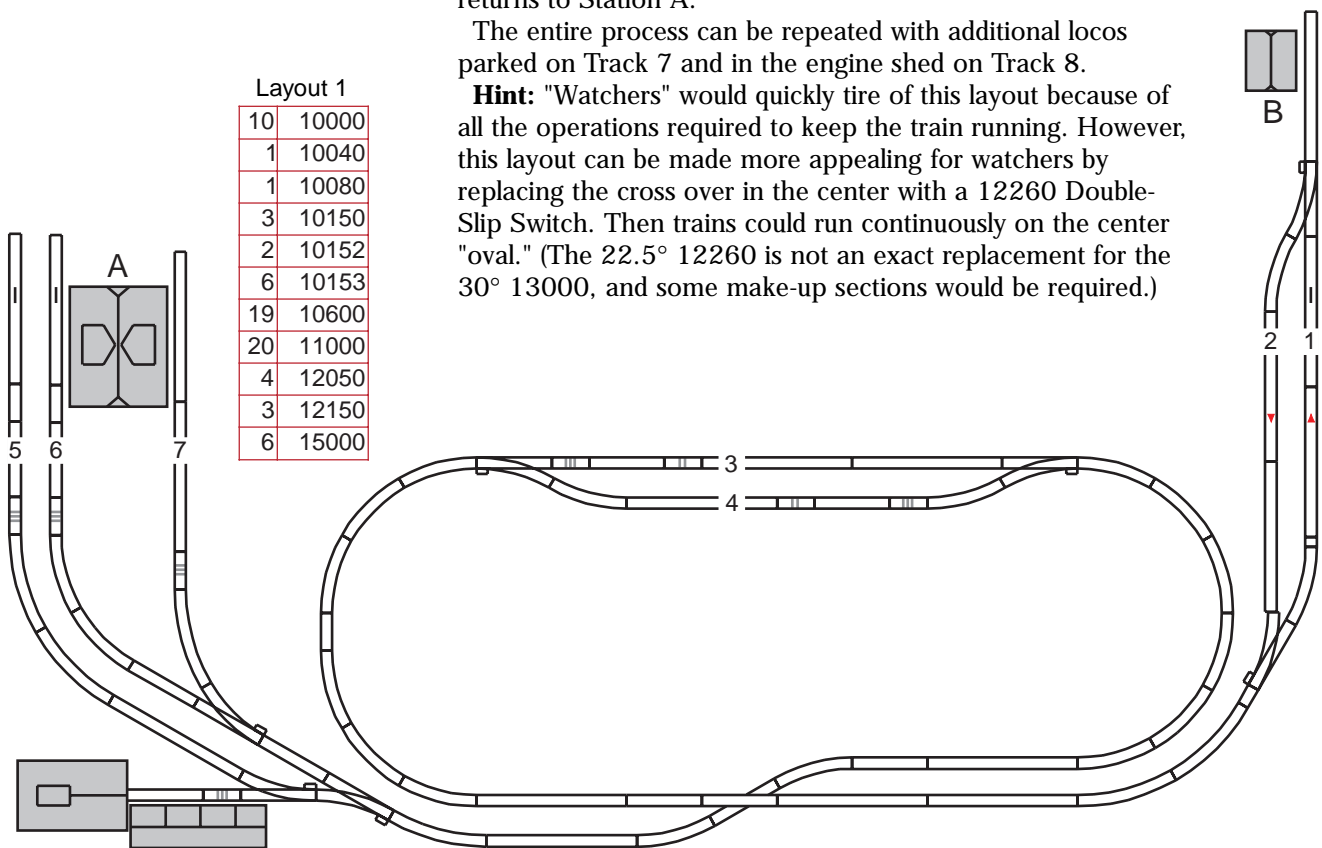

This layout could be called a point-to-point-to-point layout. Trains leaving Station A can go to the elevated Station B ($H=+21$ or Height = +21 centimeters) or to Loading Dock C, which is below Station B ($H=\pm 0$). Easy switching is made possible by uncouplers (manual or electric) on the station tracks.

This layout offers two interesting advantages. First, it could easily be bent to fit along a wall or fence, making it a good "perimeter" design. Second, all of the layout is easily accessible. Accessibility is especially important on layouts made for "operations" since accidents will happen when people are moving trains back and forth.

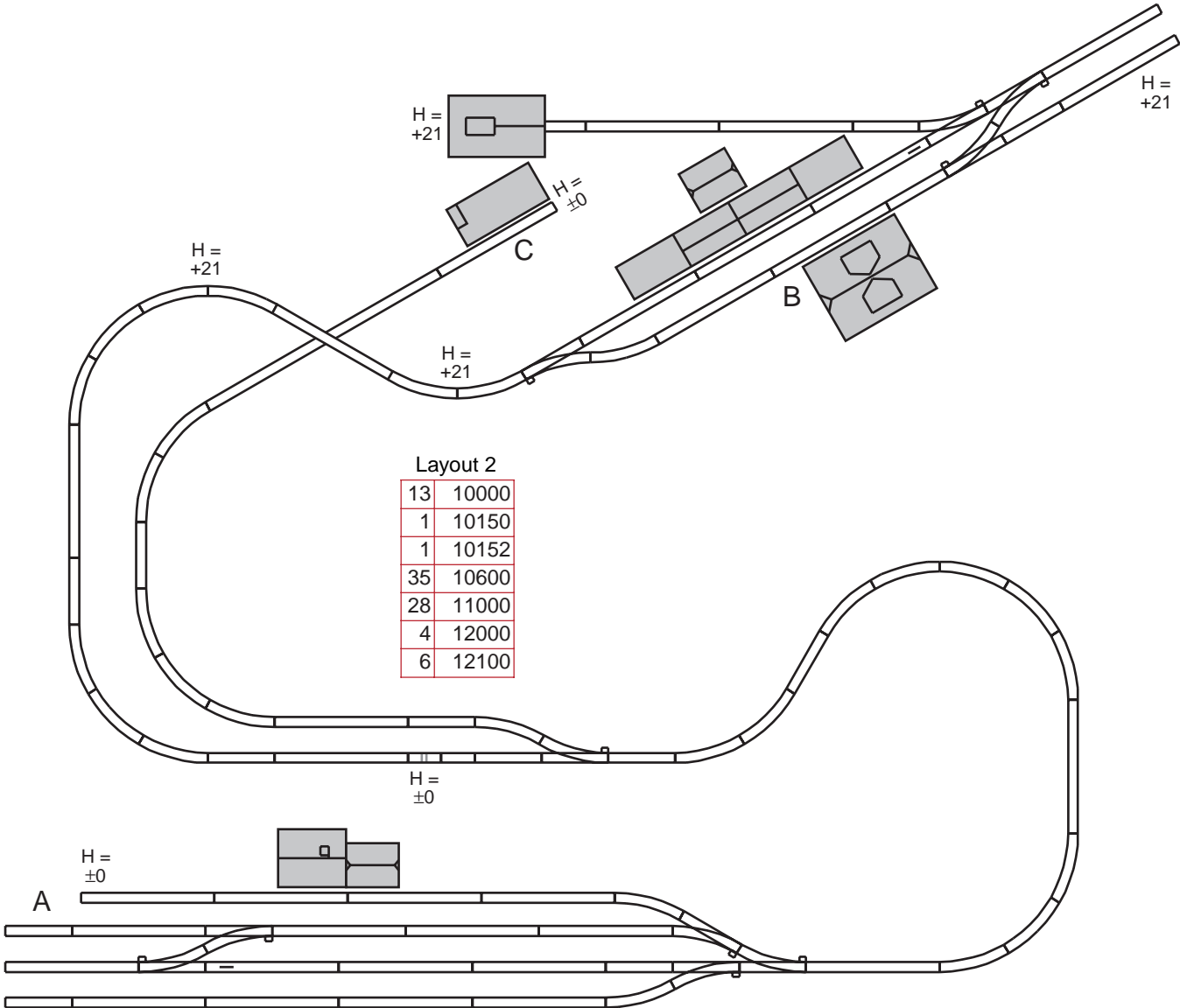

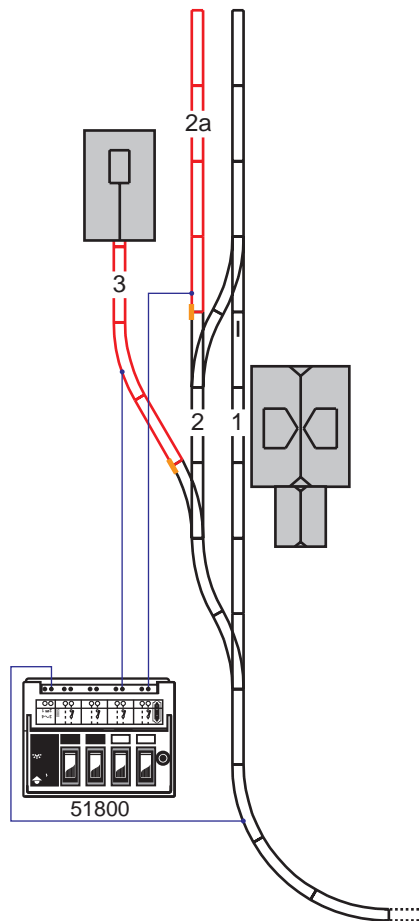

Layout 3

16	10000
5	11000
2	12000
2	12100

Stations

Multi-track stations can be added to any kind of layout to add operating opportunities. Plus, stations give you places to park your trains, even if you don't like operations. Here are some typical station designs:

This station (Layout 3) is designed for the end of a point-to-point line. A train enters on Track 1. The locomotive is uncoupled at the 10520 Manual Uncoupler. Now, the locomotive can be moved to the new "front" of the train on Track 2.

Or the locomotive can be parked on Track 2a, a manual siding block (see Page 108), and a new locomotive can be driven out of the manual siding block on Track 3.

Notice that this station is very short. It can, however, be extended with simple straight sections. Also, the length of the 51800-controlled manual siding blocks should be as long as the "electrical length" of the train.

This classic station (Layout 4) can be added to almost any layout plan. It offers room to park two trains plus an additional locomotive. A unique feature here is the connection between the departure signal (S2) and the 51800-controlled manual siding blocks. The 51800 is wired through the signal, and so, nothing can move through the blocks unless the signal is set for "Go."

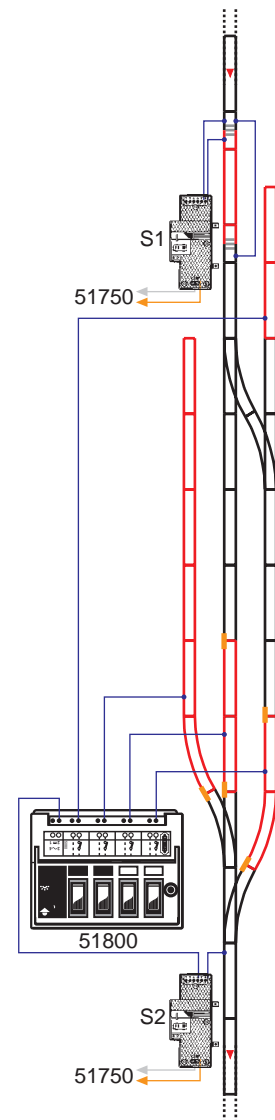

Layout 4

22	10000
2	10153
2	11000
1	12000
3	12100

Building with Blocks

This station looks impossible, doesn't it?

Impossible to build. Impossible to operate. Right?

Wrong. This double-track station looks far more complex than it actually is. It's actually constructed from very simple building blocks, including manual track blocks (Circuit 2) and manual signal blocks (Circuit 12). The switches are electrically controlled, but if you were energetic, you could control them all manually. None are interconnected with track power.

The white tracks in the plan handle all trains moving clockwise on the double-track layout. The yellow tracks handle all trains moving counter-clockwise.

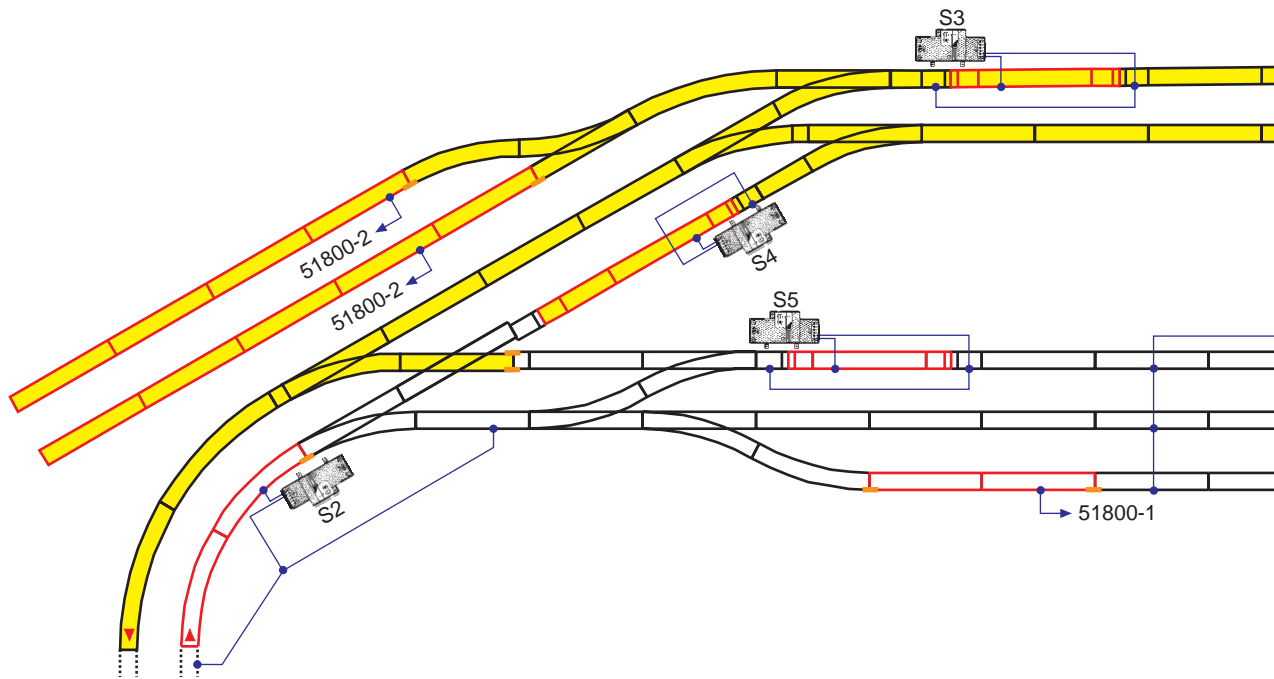

Layout 5
(1:20)
6.4 x 1.7 m

53	10000
4	10040
1	10080
5	10150
2	10152
9	10153
9	11000
7	12050
6	12150
1	13000
3	15000

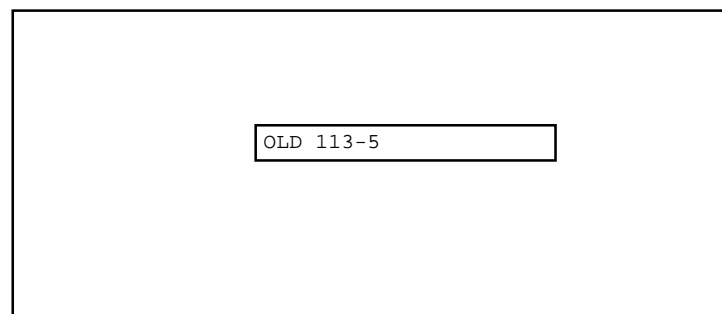

The unique feature here is the crossing on the left side of the station yard. It allows traffic to interchange between the yellow and white sections. Signals (S4 and S5) provide protection from accidental crossings. That protection is not absolute, and caution is required to prevent accidents.

Also, when trains cross from one section to the other, the power packs (or speed controls with transformers) connected to the sections must be set for the same track polarity and approximately the same track voltage.

Hint: This station layout could be further simplified by using the Multi-Train System. The Multi-Train System would eliminate the need for the electrically isolated manual track blocks, but you would want to keep the manual signal blocks for accident protection.

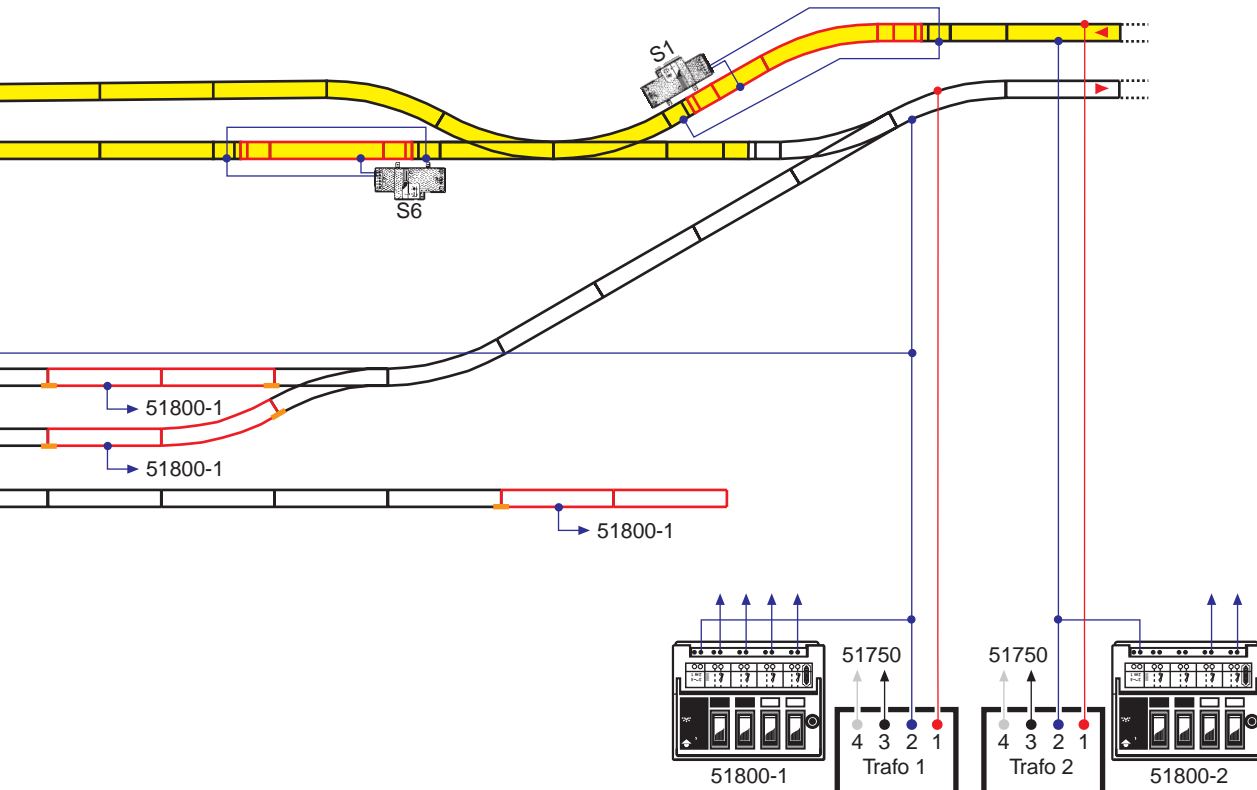

Expansion Plans

If you do not have the time or money for a complex layout, you can start with a simple layout and add to it over many months or many years. (The LGB program is very stable, and few track sections have ever been discontinued.)

This layout starts with a basic collection of 300 mm straight sections and R1 curved sections (Layout 6a). There are only three switches and one crossing, and if circumstances require, even the switches could be eliminated from the plan.

The second generation plan (Layout 6b) adds just two switches and a small amount of track. However, the operating opportunities have been dramatically increased by the installation of 51800-controlled, manual siding blocks. The next expansion (Layout 6c) is the most dramatic. R2 curved sections have been used to create a double-track main line for two-train operation. Add structures and tunnels, and you have a very impressive layout in a very small space.

Layout 6a

24	10000
1	10040
1	10080
1	10150
24	11000
1	12050
2	12150
1	13000

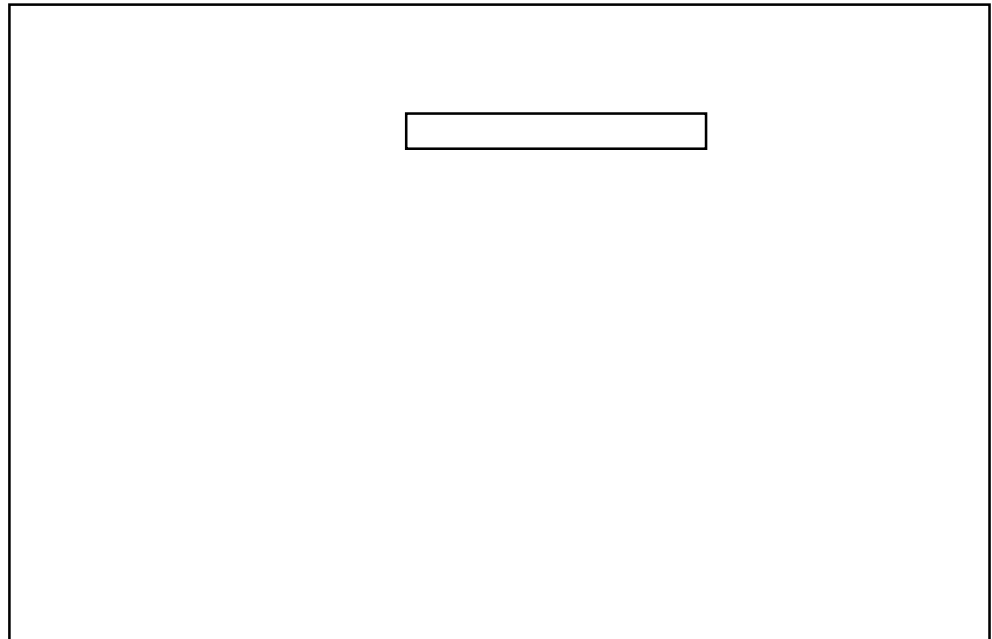

Layout 6b

27	10000
1	10040
3	10080
7	10150
5	10153
26	11000
1	11020
1	12050
3	12150
1	13000

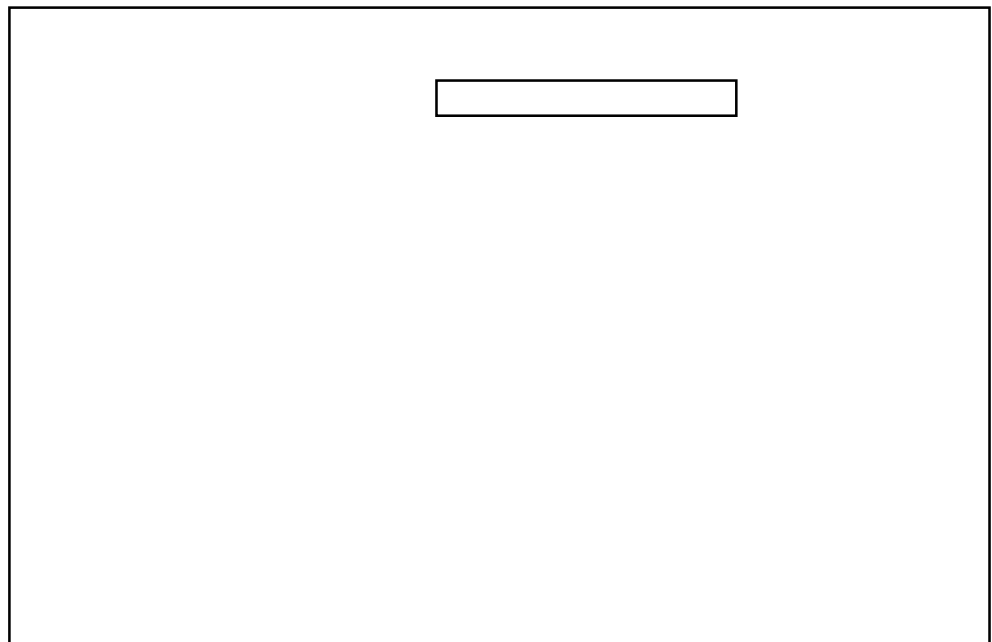

Layout 6c

34	10000
3	10040
5	10080
8	10150
9	10153
24	11000
2	11020
3	12050
6	12150
1	13000
12	15000

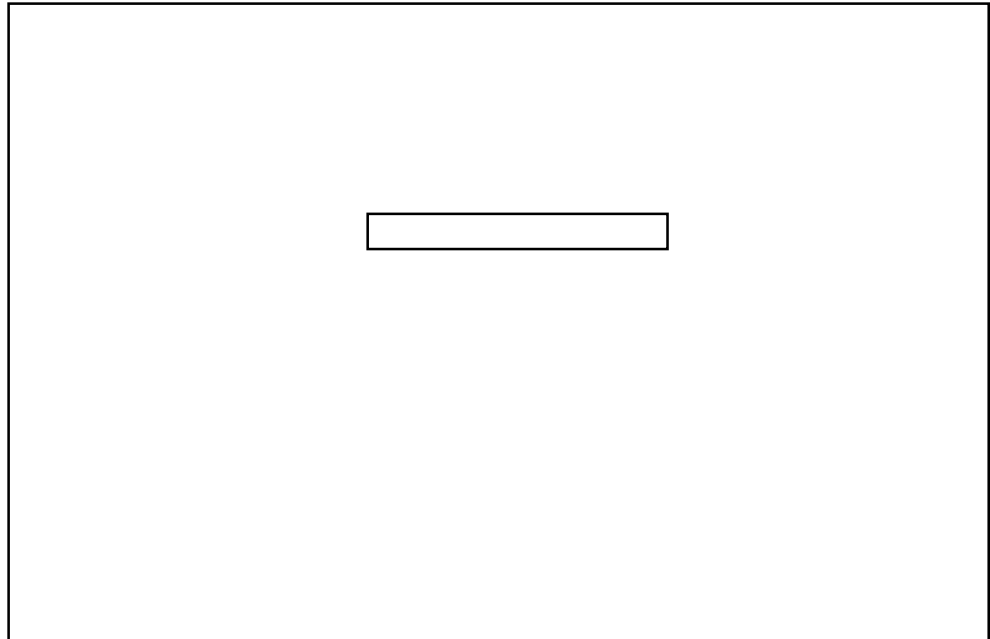

Combination Layouts

With these layouts, there can be peace between the watchers and the operators in your family. Both allow continuous train travel, but both also provide sidings and special features for switching.

The outer track of Layout 7 is a simple "dog bone" oval. In this example, the oval is folded once, but it could also be straight (for along a fence) or folded a second time (to fit in a garage). Trains can run continuously around the oval.

Meanwhile, switching operations can be conducted independently on the tracks inside the oval. The inner section is electrically insulated from the outer oval and has its own power supply. (The isolated block also prevents the accidental creation of a reversing loop.)

Typically, the inner section would be subdivided into several manual siding blocks so locomotives could be parked while other locos are switched. EPL signal circuits could be added to the outer oval to automate operations there.

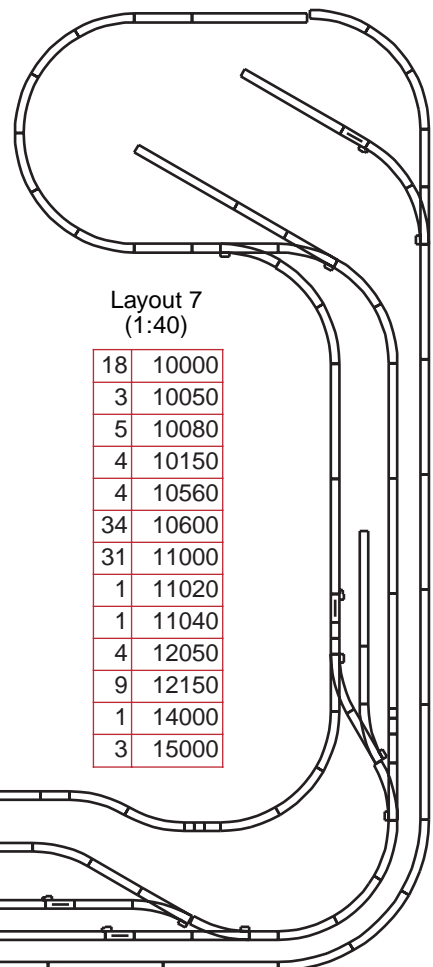

Layout 7
(1:40)

18	10000
3	10050
5	10080
4	10150
4	10560
34	10600
31	11000
1	11020
1	11040
4	12050
9	12150
1	14000
3	15000

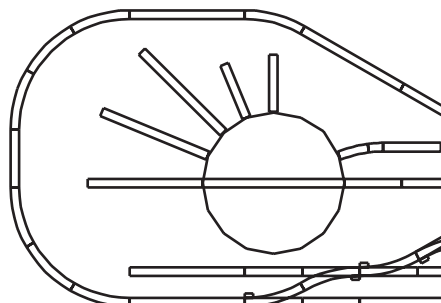

Hint: The turntable shown in this layout is an LGB 14000 Manual Turntable. This indoor-only turntable is a "limited availability" item. Also, several G-scale accessory makers offer American and European style turntables for indoor and outdoor use.

This layout (Layout 8) offers watching and operating pleasures in a relatively small area. A train can circle on the "dog bone" oval. Semi-automatic stops at the station on the left can be arranged with a Semi-Automatic Signal Circuit (Circuit 13). Fully automatic timed stops can be arranged with a 53750 Timer circuit (Page 165).

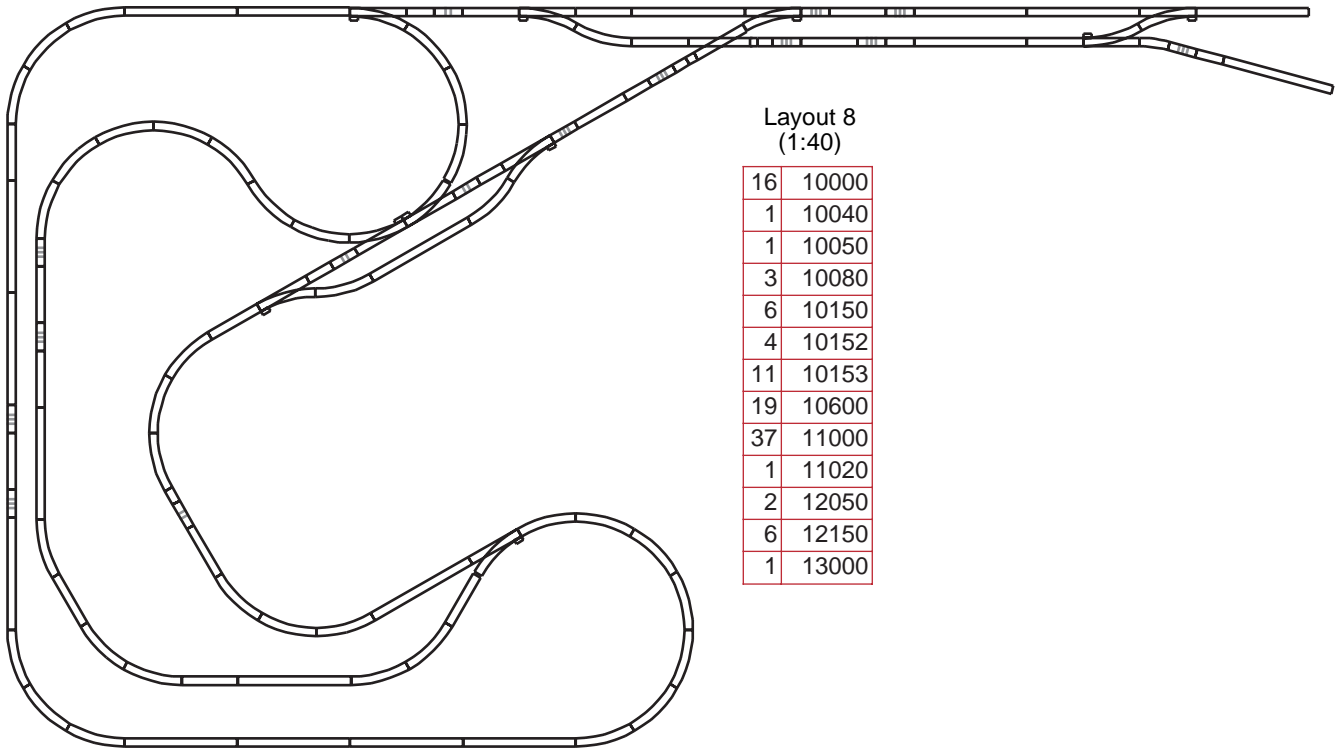

Layout 8
(1:40)

16	10000
1	10040
1	10050
3	10080
6	10150
4	10152
11	10153
19	10600
37	11000
1	11020
2	12050
6	12150
1	13000

Layout 9
(1:40)

2	10000
1	10040
1	10150
26	10600
19	11000
6	12050
6	12150
1	13000
12	15000

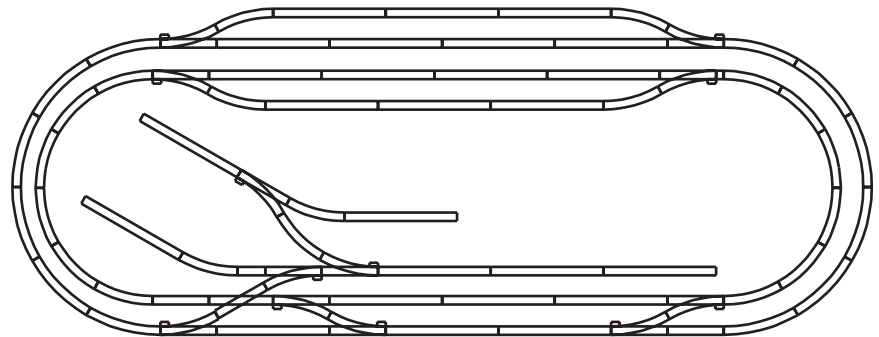

Two-Track Layouts

LGB 15000 and 11000 curved track sections can be used together to create relatively compact two-track layouts for independent two-train operations. Naturally, you will need two separate power packs (or speed controls with transformers).

Layout 9 features a large hidden storage yard in the rear of the layout. Two trains can be parked here while two other trains travel around the layout. However, extra caution is required on this layout because of the crossing that allows the "outer" line to cross the "inner" line.



Layout 10
(1:40)

1	10000
3	10050
5	10150
1	10152
2	10560
27	10600
20	11000
8	12050
4	12150
6	15000

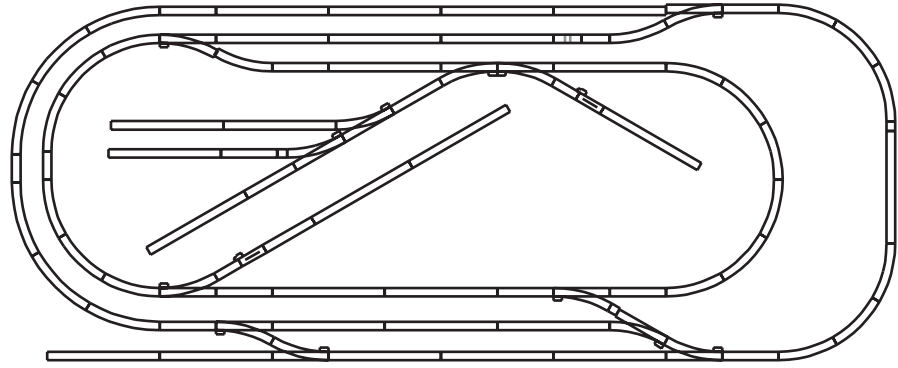

The outer line on Layout 10 could be an express line for high speed passenger trains. The inner line could be for engine servicing and storage. The inner and outer line do not cross but it is possible for trains to move between the lines in the station yard and via a crossover track (between the inner and outer lines at the top of the layout).

Layout 11 is very similar to the dual-purpose "dog bone" we described on Page 149. A large outer oval has been added for continuous two-train operation.

This design has a big benefit. It offers the illusion the trains are going different places. For example, the purpose of the inner oval could be to move people around a city. The purpose of the outer oval could be to move lumber from the forest to the city.

This design also has a big problem. The inner tracks are inaccessible from the outside of the layout. To reach the inner tracks, you must cross over, under or through the layout.

Layout 11
(1:40)

20	10000
4	10040
3	10050
1	10080
8	10150
2	10153
38	10600
36	11000
4	12050
14	12150
1	13000
6	15000

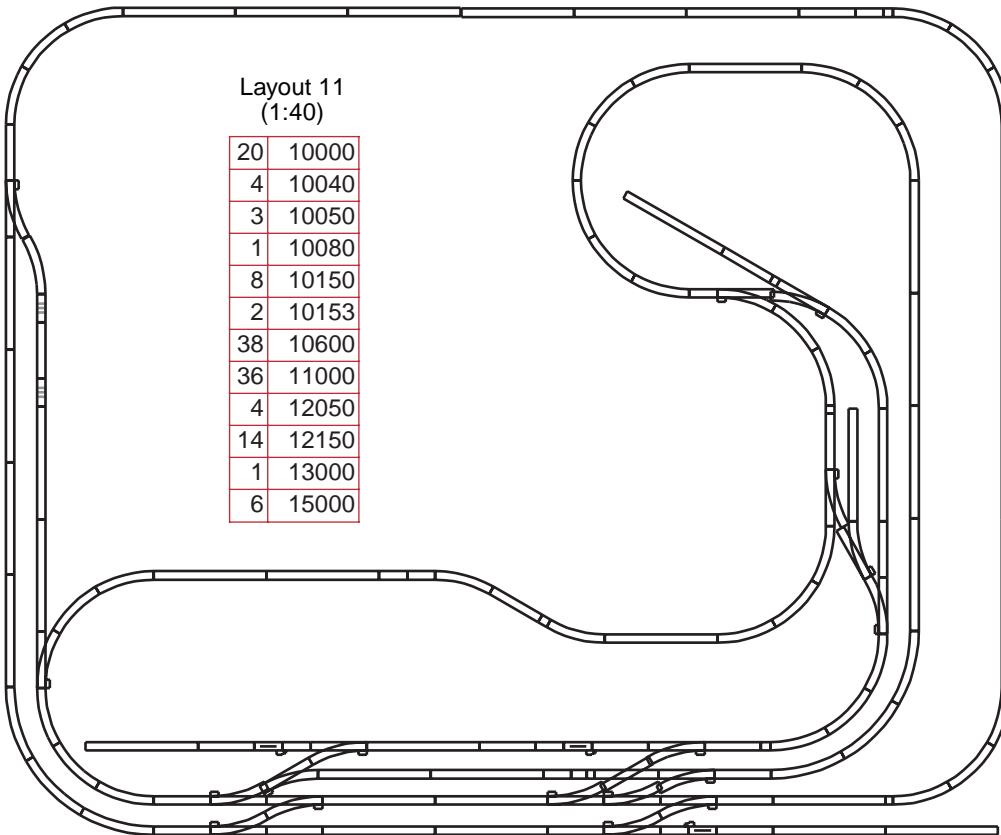

Indoors, the solution to this problem is a hinged or removable track section. For example, the bridge on the top of the layout could be hinged. Two 10090 Adjustable Track sections could be used to close the gaps at the end of the bridge.

If the layout is built at ground level outdoors, the track could be built into a walkway. LGB track will withstand moderate foot traffic if the track is properly supported, for example, by pressing the track into wet concrete.

**A Lot
in
A Little**

This layout was designed and built by Jan Martensen of Hamburg, Germany. The track plan here (right) was drawn using a 10010 Track Planning Template.

At first, the plan appears to be very complex. However, it is essentially just a two-track

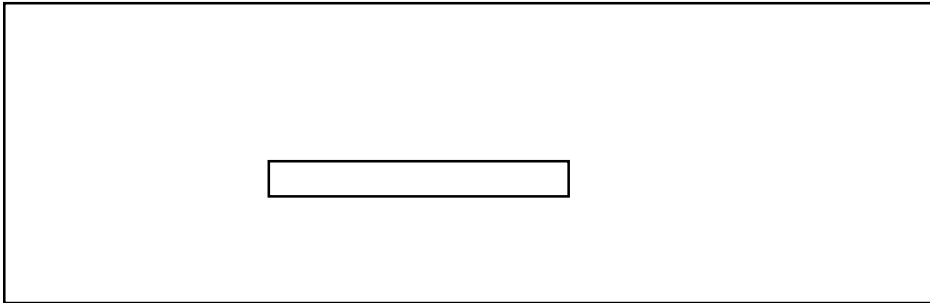

This efficient plan packs a lot of action into a little attic.

layout. There are two large ovals, shown in yellow and white. They are connected together at a "wye" with a third line, shown in blue.

The yellow and white lines are level, suited to continuous operation of long trains. The blue line is a very steep (7%) line featuring a spiral that rises 260 mm (10.2 in) from the ground in one turn. All of these lines provide many watching and operating opportunities in a very small space, just 6.9 m by 2.9 m (22.6 ft by 9.5 ft).



A well-designed LGB layout can be interesting to watch and interesting to operate.

The second layout is a remarkably small layout that offers a remarkably large amount of train activity. The visible station (1) in the center of the layout is located on a single-track line in the Alps. A train arrives at the visible station, departs and disappears into the mountains. Meanwhile, other trains arrive, depart and disappear...all on a single mainline track.

The trick is the "shadow" station (Gleis 1a, 2a, 3a) hidden behind a mountain scene. Trains go there and wait for a time, until they are dispatched manually (e.g., by a person using the Multi-Train System) or automatically (e.g., by an EPL circuit.) In the station yard (Gleis 3, 4, 5), trains can be "made up" and "broken down."

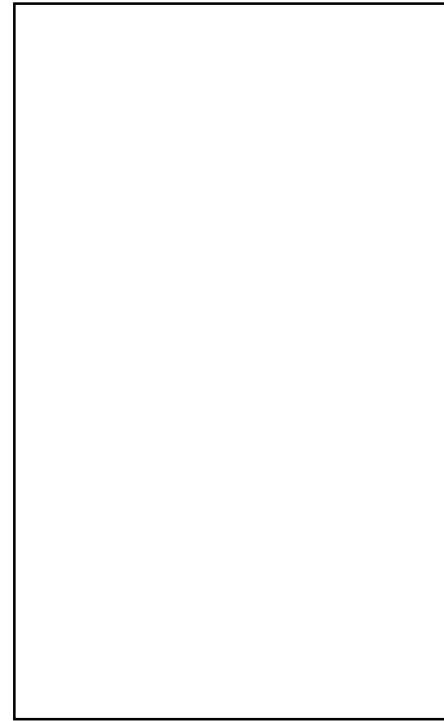

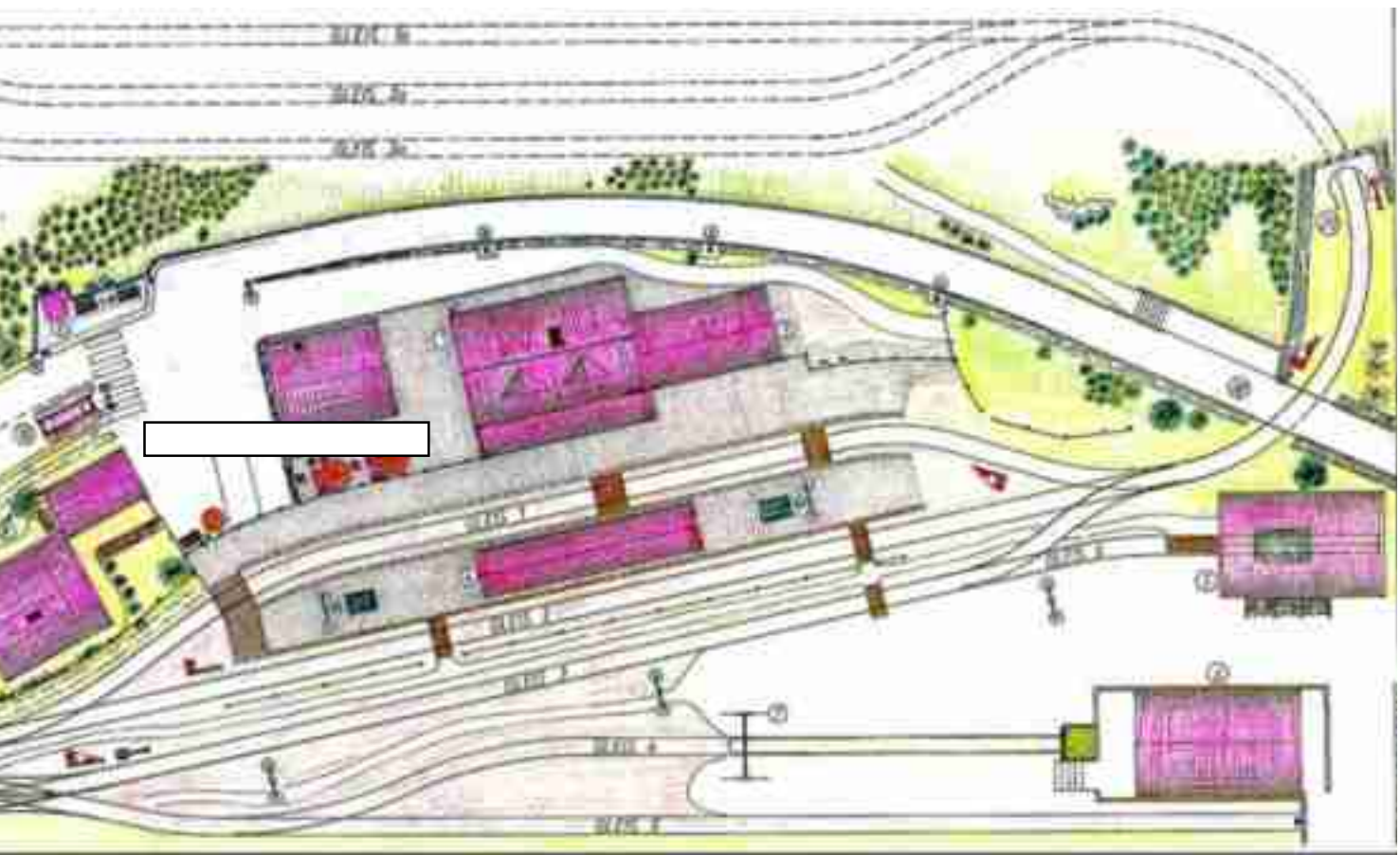

- Key to Structures
- 1 - Passenger station
 - 2 - Restaurant
 - 3 - Rest rooms
 - 4 - Platform
 - 5 - Engine shed

- 6 - Freight shed
- 7 - Load scale
- 8 - House with garage
- 9 - Bus stop
- 10 - Construction site
- 11 - Grade crossing

- attendant's house
- 12 - Coaling station
- 13 - Water crane
- 14 - Crossing gates
- 15 - Mill
- 16 - Mill bridge
- 17 - Railroad bridge
- 18 - Elevated highway
- 19/20 - Tunnel portals

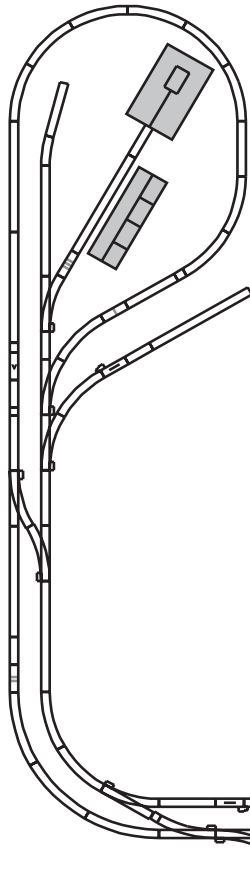

Reversing Loop Layouts

Reversing loop layouts have many of the advantages of both oval and point-to-point layouts. Reversing loop layouts do, however, pose special electrical challenges, but those obstacles can be easily overcome using the circuits in Chapter 9.

This reversing loop layout can be lengthened to fit many spaces. Just add more track between the loops. It is shown with "K/T" reversing loop sections, but any of the reversing loop circuits from Chapter 9 (Manual K/T, Automatic K/T or Automatic) could be used on either loop.

In this example, one of the loops is concealed with a tunnel. A 53750 Timer can also be used to automatically stop the train in the tunnel for a short period, artificially increasing the apparent length of the tunnel.

Layout 12
(1:40)

11	10000
2	10040
3	10050
1	10080
6	10150
2	10151
1	10152
7	10153
2	10560
18	10600
22	11000
2	11020
5	12050
6	12150
3	15000

Flex-Track Layout

Flex track is the choice of many experienced layout builders. It allows you to fit spaces and solve problems impossible with regular "sectional" track. Flex track also lets you create complex, but smooth, curves for improved operation and appearance.



LGB flex track can be combined with regular LGB track sections to create fascinating custom layouts.



The photos on these pages show this layout both during and after construction.

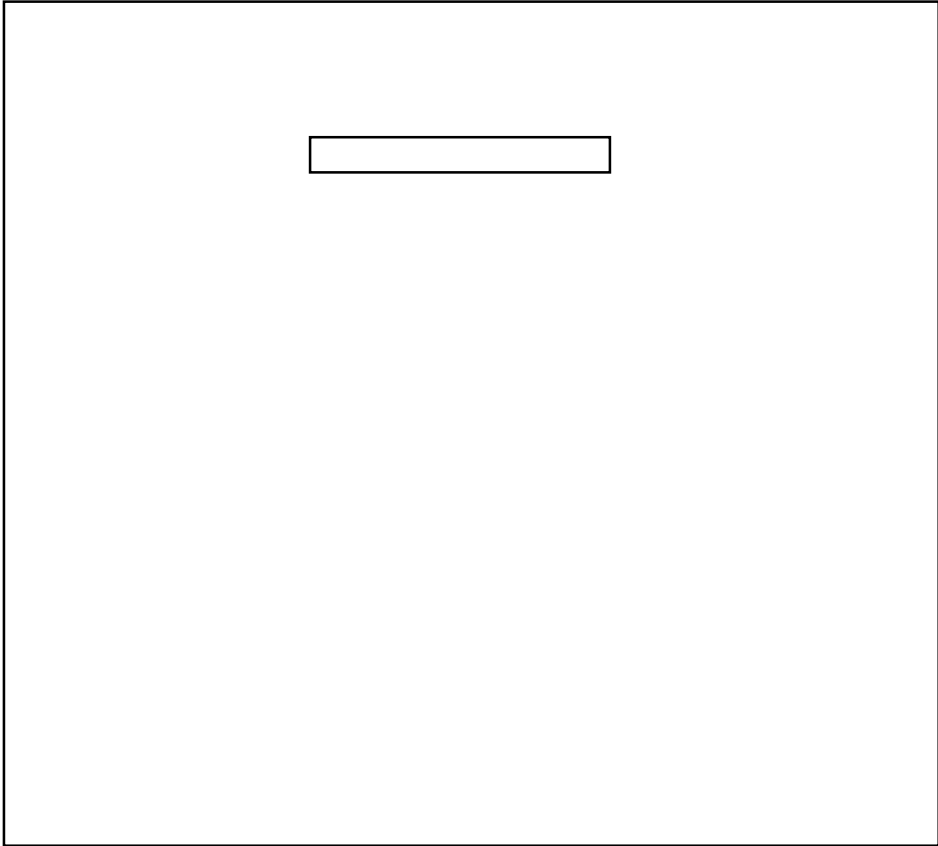

For example, this compact, curvaceous layout would be extremely difficult to build with sectional track. In fact, the only sectional track sections in this layout are the switches and insulated track sections.

Despite its many twists and turns, this is nothing more than an oval layout. It looks complex because the oval has been folded over itself twice

LGB flex track can be used to construct smooth, complex curves for improved appearance and operation.



and because of the four-track station yard. The layout does feature steep grades, up to 5%, that limit the number of cars locomotives can pull on the layout.

Lang Garden Bahn: Reverse Loop Expansion

It's a natural thing. LGB fans accumulate LGB trains. Over several birthdays and holidays, Alex assembled a nice collection of LGB freight cars. Paul slowly put together a full set of Durango & Silverton locos and passenger coaches, and Heidi saved to buy her own Orient Express Set with its big 0-6-6-0 Mallet.

Of course, once you have more trains, you need more track. So the next big step for the Langs was to expand their layout. The expansion is actually a new loop-to-loop layout, connected to the original layout by a crossover track near the center.

Traveling down from that center point, the new layout climbs a grade behind the old layout. To simplify construction and reduce the number of rail joints, extra-long 10610 straight sections were used on the grade. Space was tight in the corner near the neighbor's fence, and so Paul used flex track to create a custom, wide-radius curve to fit the corner. Then, the new layout loops over the old layout, using bridges to cross the original track.

Traveling up from the center point, the new layout bends gently through two ultra-wide-radius flex track turns. Also, the upper loop is made almost entirely of flex track, except for the station area.

Since the Langs are using the Multi-Train System, they choose Circuit 10, the "Fully Automatic Reversing Loop," to handle the electrical chores required by the two big reversing loops. With this circuit, trains can enter the loops in either direction, and trains can maneuver freely within the loop.

The result is a long layout with wide-radius turns that is well suited to continuous operation of long, impressive trains. Combined, the two layouts give the viewer an illusion of great activity, without a lot of complexity. Combined, the two layouts give the Langs a feeling of great satisfaction, without a lot of work.

Layout 13
(1:75)

43	10000
8	10005
4	10040
1	10050
4	10151
9	10610
3	11000
4	12000
5	12100
35	15000
1	16000
2	16150

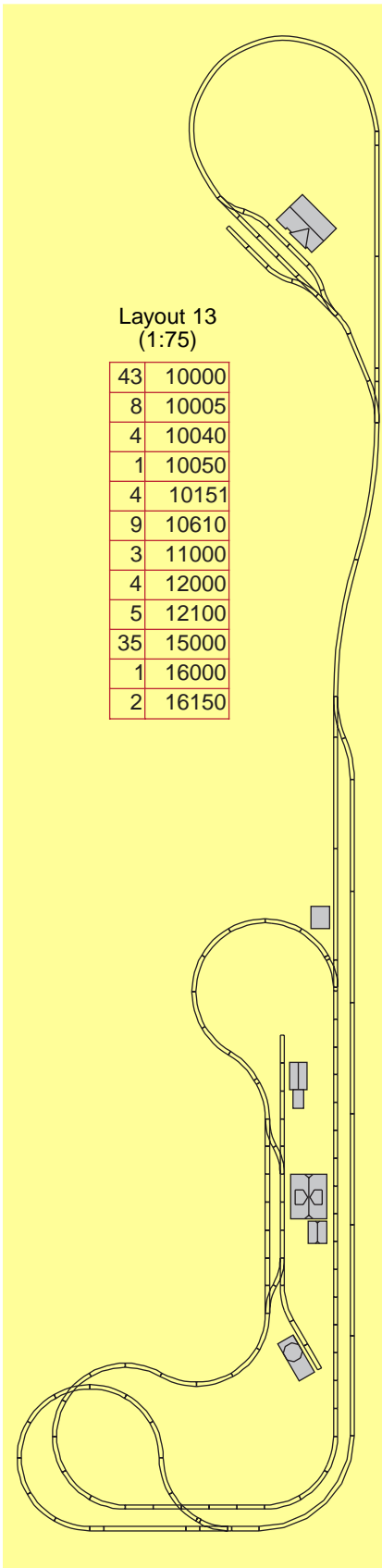

Discoveries: Operations on the Colorado & Western

Story and Photos by Frolin Marek

Your little 2-8-0 engine groans as it tugs the string of cars around the curve, up the grade into the town of Silverton. You ease into the siding and let the southbound "Silverton" passenger train pass by as it departs for Durango.

You can recreate the action of a real railroad on your own LGB layout.



You have some switching to do here, and your brakeman has a list of which cars go where. You need to drop off a loaded boxcar at the depot, pick up an empty flat car and spot an empty refrigerator over at the team track.

All this has to be done before you can head to Cripple Creek and then to home. It's another busy day of operations, switching on the Colorado & Western Railroad. Boy, who knew playing with G-scale trains could be so much work...and so much fun!

This is just another day of operating trains on Barry Bogs' indoor large scale layout. This fantastic layout has been featured in *LGB Telegram* and *Model Railroader* magazine. Now, I'd like to give you an idea of how we "operate" this railroad using a "switch list" system.

Switch Lists

Using quality LGB components, Barry has scratchbuilt some of the world's finest large scale locomotives. But what do you do with them? For over five years, I've been helping Barry run these fine trains. And in the last two, we've worked together to bring "operations" to the railroad. This now includes a computer-generated switch list system.

Before I go much further, let me stress that "operations" can be just like a garden railroad track plan—very complicated or very simple. Not everyone has a complex layout at first, but many will expand once the first loop is running.

COLORADO & WESTERN Railroad

Engineer: Paul 6/3/95
 Cars to switch: 10 9:15am

```

=====
Roadname  Car #  Type      Location      To/From      Done
=====
Starting Train in Durango:
D&RGW    4073  Gondola   Durango Yard  Silverton    _____
E.B.T    880   Hopper    Durango Yard  Cripple Crk  _____
D&RGW    4068  Stock     Durango Yard  Cripple Crk  _____
G&D      285   Boxcar    Durango Yard  Silverton    _____
Gramps   18    Tank      Durango Yard  Cripple Crk  _____
=====
Silverton—Pick-ups:
D&RGW    4060  Flat car   Team Track    Cripple Crk  _____
C&W      4067  Boxcar     Warehouse     Durango      _____
=====
Silverton—Drop-offs:
G&D      285   Boxcar     Depot Spur    Durango      _____
D&RGW    4073  Gondola    Team Track    Durango      _____
=====
Cripple Creek—Pick-ups:
D&RGW    861   Gondola    Bogs Mine     Durango      _____
D&RGW    862   Gondola    Bogs Mine     Durango      _____
C&S      4167  Boxcar     General Store  Cripple Crk  _____**
=====
Cripple Creek—Drop-offs:
D&RGW    4060  Flat car   Depot Spur    Silverton    _____
D&RGW    4068  Stock     Interchance   Durango      _____
Gramps   18    Tank      Oil Facility   Durango      _____
E.B.T    880   Hopper    Bogs Mine     Durango      _____
  
```

This 10-car switch list shows a busy day for Paul the engineer.

you return to the Durango yard. Step by step, town by town, what to switch and where...

As you can see in the sample, there is a lot to do with just a ten-car switch list, and this list may take up to an hour to execute. Plus, every list from the computer is different--you may never see the same switching in one town and barely any switching in another.

Let's breakout some of the information on the sample switch list and explain it. The "Roadname" is pretty obvious, as is the "Car #" and "Type." The "Location" list tells us where to drop off the car or where it is to be picked up. The "From/To" column contains side-notes, just to let you know where the car came from, or where it is going. The line on the end simply provides a place to check off when the car has been moved.

Look at the first car on the list, the D&RGW gondola, car number 4073. You have to put it in your train when you are starting the session in the Durango yard. Its destination is Silverton. If you look under the Silverton Drop-offs, you will see the 4073 gondola there, along with an indication under the "Location" column that says the gondola now must go to the Team Track. And now the line notes that it came "From Durango."

Operations

So how do we go about "operating" the trains on the layout? That's easy, too! On the C&W, Barry can run up to five trains at one time. Of course, each train has to take its turn in each town. Now we simply need trains and train crews!

Operating follows the same concept—you can start simple and add more later. A paper "carcard" system can certainly be used for railroad operations, but we operate on Barry's layout using a computer list.

What is a switch list? Just a list of cars with notes telling you where to pick each car up and where to drop it off on the layout.

In the past, switch lists were often a simple hand-written document generated by a person known as the "Dispatcher." No matter how simple they are, switch lists have a common goal—to simulate the activities of a real railroad.

Switching

Once you have a "switch list," it's time to go run trains!

The switch list that appears on the opposite page is from a simple list program. As you look down the list, you will notice that it is in C&W town order. First, your starting train is built in the yard before you leave Durango. Then you have pick-ups and drop-offs in the town of Silverton. The next switching is slated for the area of Cripple Creek. Finally, you have the cars that should be in your train when





Barry Bogs is surrounded by his LGB mountain layout, the Colorado & Western RR.

We need an engineer to run a train. Often, we use a two-person team for operating. Having a conductor/brakeman along makes things easier. That way, the engineer can run the train and switch cars about while the conductor/brakeman maintains the switch list, instructs the engineer on which cars to move where and throws the turn-outs. And although a two-person operating team is more convenient, operating can certainly be done with one "engineer"--it simply depends on how many people you have who want to play! What about your train? Well, you have a switch list in hand, you need some cars from the Durango yard--

the only thing missing is an engine and caboose. Do you want to use a D&RGW K-27 or the C&S Mogul to pull your train today?

With the operating session underway, you pull your chosen engine out of the roundhouse, turn it on the turntable, coal and water it, build your train and then grab a caboose. Sometimes, we have one person who acts as the "yard hostler." His job is to do all the yard work for you. This helps get you out on the line faster.

On a larger layout such as Barry's, you need to designate one person to act as your railroad's dispatcher. The dispatcher's job is to give clearance authority to a train for a section of the railroad. When you run multiple trains on one layout, you need to make sure you don't have a local freight headed uphill while the Silverton passenger train is coming downhill!

Normally, the dispatcher also runs a main control panel if you have a layout that is wired for multi-train block control. (That's not necessary if you have LGB's digital Multi-Train System.) Of course, in a simple operating session with one train, the dispatcher simply watches—and retrieves the beverages!

Now your trains are running... Paul is taking his Mogul-powered freight around to Cripple Creek after the switching in Silverton is finished. At the same time, Brian pulls his Forney-led train into Silverton to start work. And Janet is in the Durango yard, building a train for Barry, using the #50 diesel switcher. Action is underway as operations keep things jumping on the railroad.

Many layout owners who enjoy switching host regular operating sessions. For example, every Tuesday night, we "play trains" on the Marek Mountain Railroad (my own G scale layout). Of course, there are other things to do on train night. Along with switching trains on the layout, we watch railroad videos, look over new magazines, work on equipment and, of course, have fun!



CHAPTER 12: LEADING THE WAY

With the EPL system – and a bit of imagination – you can bring your layout to life.



In earlier chapters, you learned the basic EPL circuits, the basic building blocks of the EPL train control system. Now, it's time to be a bit more creative. With the EPL system, you can control dozens of different functions on the same layout...or dozens of different functions at the same time. The only limit is your imagination.

In this chapter, you'll see some EPL circuits designed to stimulate your imagination, including circuits using the versatile 53750 Timer. As you study these circuits, remember that the key is to work step-by-step, one component at a time. Then, the maze of wires will be easy to understand.

Alternating Route Circuit

Frequently, EPL circuits are used to operate more than one train on one track. However, this EPL circuit is designed to operate one train on more than one track.

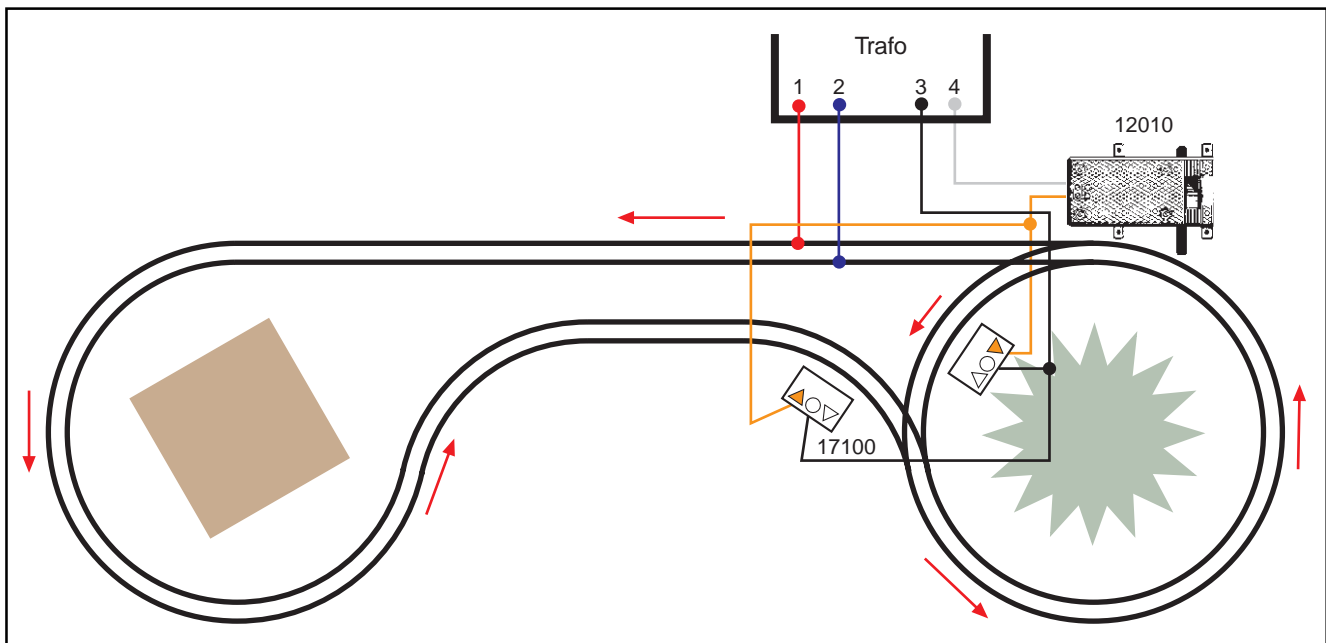

It's very simple. Two 17100 Track Contacts are connected to one electric switch (i.e., a 12010 Switch Drive mounted on the upper switch in this diagram). That electric switch controls which route the train takes. The 17100s are mounted at the end of each route. When the train crosses the 17100 at the end of one route, it sets the electric switch for the other route. When the train crosses the 17100 at the end of the other route, it sets the electric switch for the original route.

Hint: The maximum train length is determined by the distance between the switches and the position of the 17100s.

This circuit was originally drawn by Drew Marshall, a professional LGB layout builder, for a customer's "Christmas Tree" layout. The train alternates between circling around the tree and detouring through the living room. It's proof that your imagination is the only limit to the uses of the EPL system.

Non-Train Applications

The EPL system is designed to control trains, but you can also use EPL components to control other features on your layout.

Imagine there is a small station on your layout. Typically, the lights of the station would be turned on just before a train arrives and turned off just after the train departs. You can use a 12030/12010 relay and 17100 track contacts to control the lights automatically.

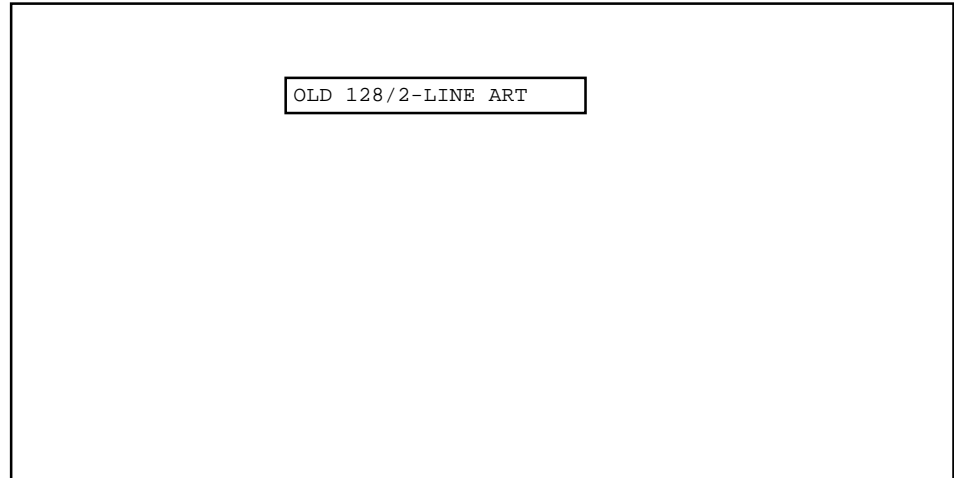

A train arriving from the left (A) crosses the first 17100 "Off" contact. Nothing happens because the lights are already off. Then it crosses the first "On" contact and turns the lights on.

When it leaves the station, the train crosses the second "On" contact and nothing happens. Then it crosses the second "Off" contact and turns the lights off.

Why are there two "On" and two "Off" contacts? To handle traffic in both directions. The 51800 switch allows you to disconnect the lights during the day.

Interconnected Relays

Most of the standard EPL circuits use only one 12030/12010 relay. However, these relays can be interconnected to form more sophisticated circuits.

In this example, two 12030/12010 relays are attached to a 12360 three-way switch. The lower relay receives power from the "hot" side of the track and distributes it to the lower branch of the switch and to the upper relay. The upper relay distributes power to the middle and upper branches of the switch.

As a result, trains can only move out of the branches if both switches are properly set for exit.

The same technique can also be used to interconnect switches and signals. In this simple "group departure" circuit (next page, top), the signal relay receives power from the "hot" side of the track and distributes it to the 12030/12010 relay on the siding switch.

With this arrangement, two things must happen before a train can depart from the siding. The signal must be set to "Go" (Hp1) and the switch must be set to the proper siding. It is a basic safety measure that emulates common practice on many branch lines.

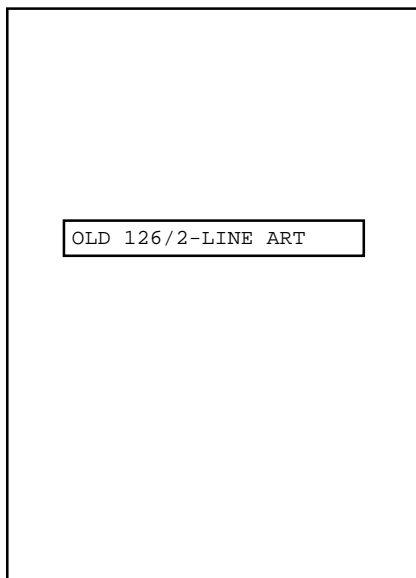

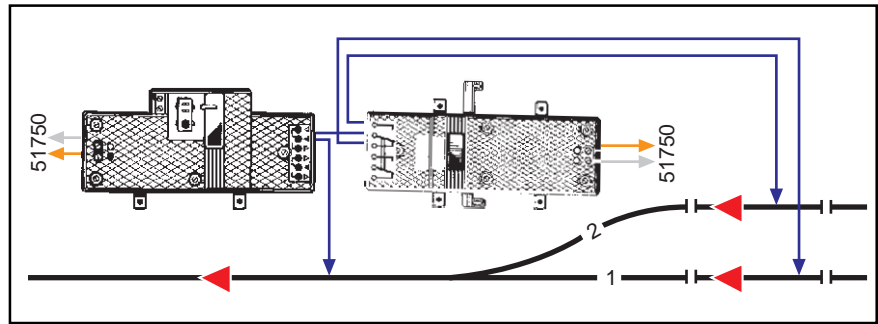

This sophisticated "departure control" circuit (below) is borrowed from the old Deutsche Reichsbahn, the former East German railway system. In this circuit, each departure siding has its own signal.

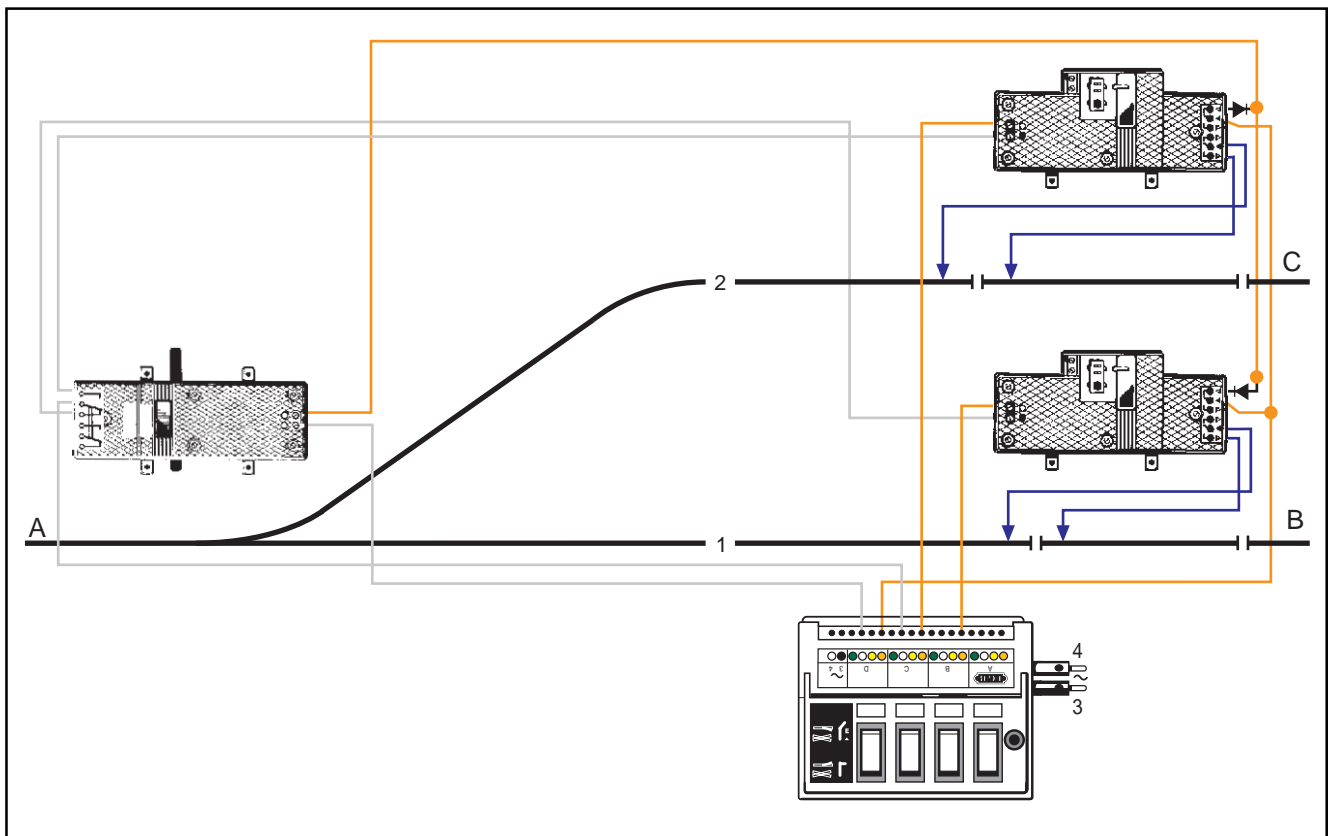

Notice that the 12030 Supplemental Switches on the signals control more than track power. Using diodes, they also route the control impulses to the 12030/12010 switch relay. With this circuit, the signal relays and the switch relay are completely interlocked. The switch cannot be moved unless both signals are set to "Stop" (Hp0). Conversely, it is impossible to set both signals to "Go" (Hp1) at the same time.

Station Signals

Signals add an element of theatre to a layout, and a station yard with many signals is a real show.

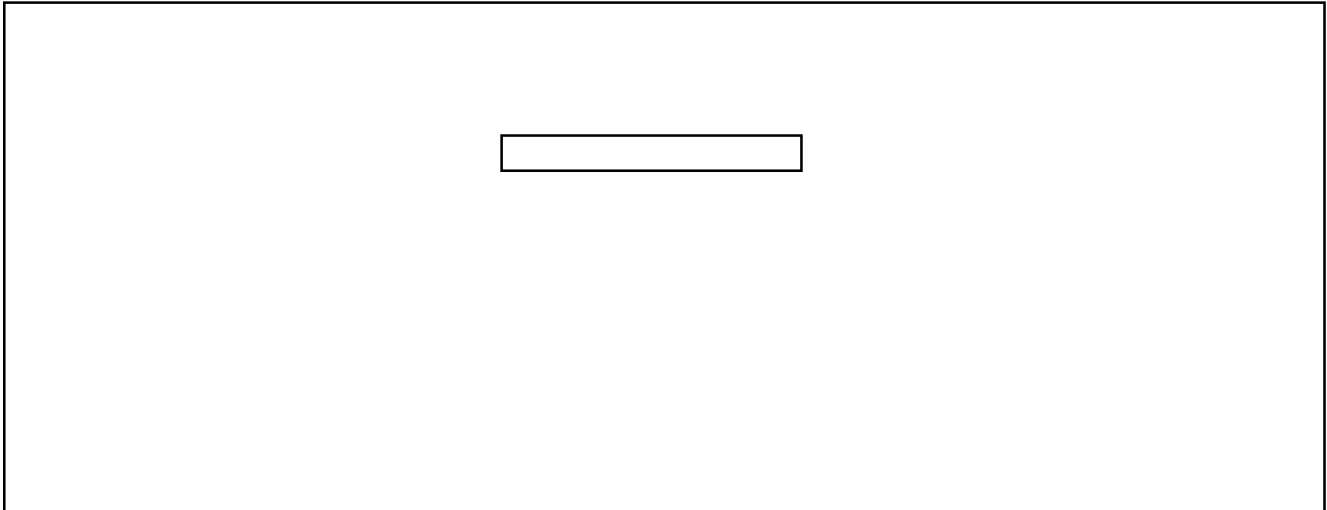

In this basic example of station signals, the "N1" entry signal is located far enough ahead of the station to allow switching operations in the station. The "N2" group departure signal controls both departure tracks, like the simple group departure circuit on Page 163. The "N3" route signal could be located anywhere along the main line route.

Of course, you can create a far more complex arrangement of station signals. In this station, traffic coming from the left merges in the station.

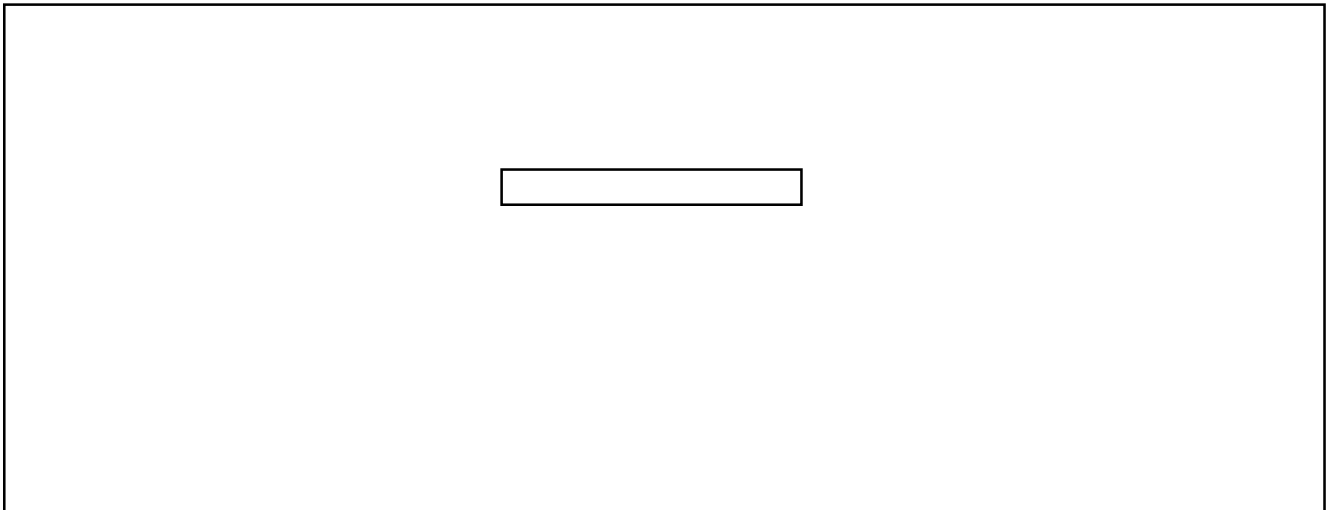

The first signals, "n2" and "n3," are distant signals connected to home signals, "N2" and "N3." (To permit close spacing of trains, distant signals are sometimes installed several signals away from their matching home signals.)

Signals "A" and "B" are used to hold traffic outside the station. Finally, signals N2 and N3 are wired as a departure control circuit, like the Deutsche Reichsbahn circuit on Page 163. The N3 signal should be mounted away from the track to provide extra clearance for cars on the curve.

The 53750 Timer

The 53750 was developed by Heinz Koopmann, Lehmann's chief technical consultant, and like Heinz, the 53750 is very ingenious, deceptively simple and incredibly helpful.

What is the 53750? It is an electronic timer connected to a double-pole, double-throw relay. The timer is variable from 2 to 240 seconds, and it can be triggered by a variety of momentary contacts, like a 51750 Momentary Control Box, a 17100 Track Contact or even a simple momentary contact switch. All of this is packaged in the same weather-resistant housing as the other EPL control boxes (51750, 51800 and 52750). The 53750 requires AC power to operate. The relay contacts can handle AC or DC, up to 5 amps per contact.

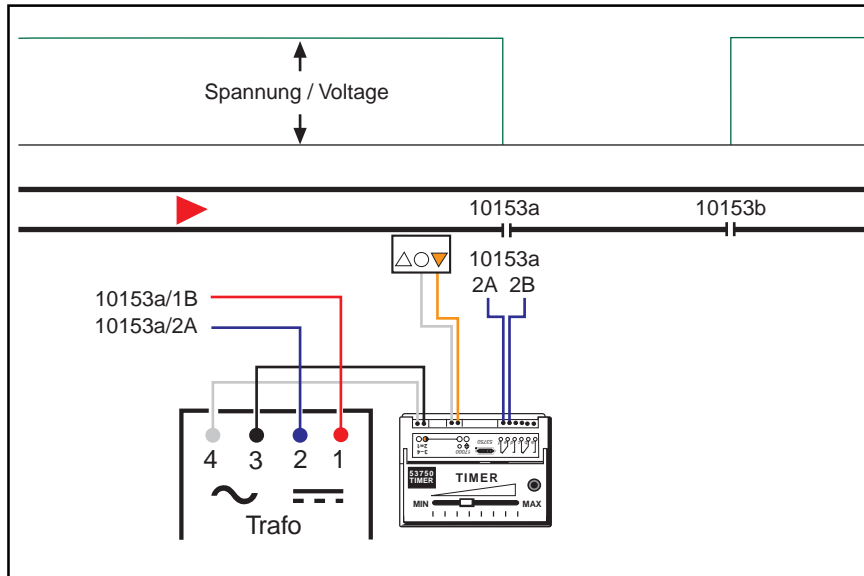

Timed Station Stop

A very simple and popular application of the 53750 is a "Timed Station Stop." In this example, a train approaches from the left and passes over a 17100 contact. The 17100 starts the electronic timer inside the 53750. The timer switches the relay inside the 53750, switching off power to the isolated track block.

The train enters the block and stops. It will remain there until the timed period is over, and the relay restores power to the block. Then the train departs. Of course, this circuit is perfect for a station, and you could even use the extra set of relay contacts to automatically switch the station lights on and off.

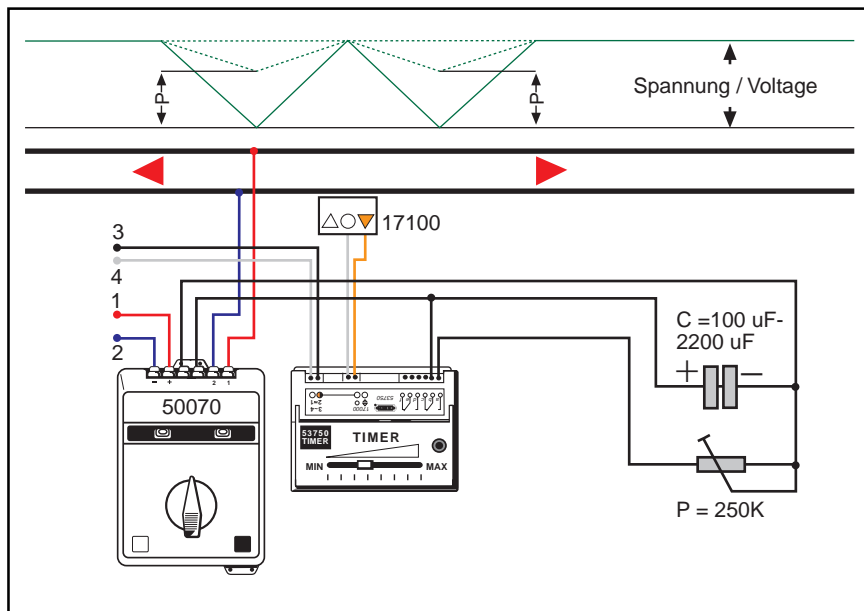

Timed Slow Circuit

If you have some experience with basic electronic components, you can use the 53750 to slow down a train at a station or crossing. As in the earlier circuit, the 53750 is connected to a 17100 contact and an AC power source. In this circuit, however, the 53750 is also connected to the auxiliary throttle inputs of a 50070 speed control using a capacitor and a variable resistor.

When a train crosses the 17100, it starts the timer, switching the relay inside the 53750. The relay connects the variable resistor

across the 50070 throttle inputs, slowing the train down. The capacitor? It acts as a buffer, making the train slow down gradually.

At the end of the timed period, the relay returns to its normal position, and the train gradually returns to its normal speed. The setting of the

variable resistor determines the minimum "slow" speed of the train. The value of the capacitor determines the deceleration and acceleration rate.

Hint: The capacitor and variable resistor are not available as LGB parts. Check with an electronic parts store in your area.

Timed Signal Circuit

On a real railroad, trains do not depart instantly when a signal changes from "Stop" (Hp0) to "Go" (Hp1). Instead, there is usually a short delay...usually while the engineer puts down his newspaper and empties his coffee cup.

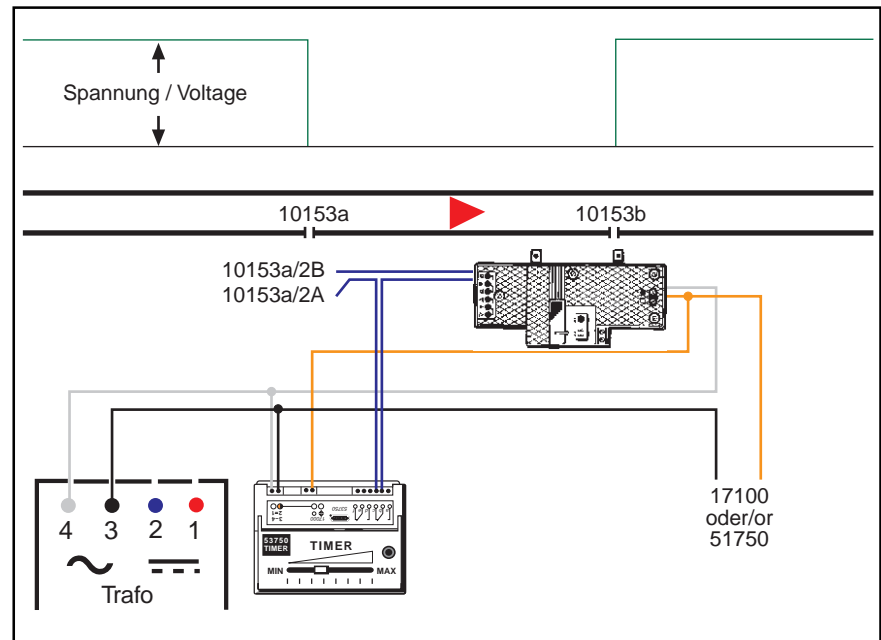

This circuit simulates this delay using a 53750 Timer. The basic circuit here is the same as the manual and semi-automatic signal circuits in Chapter 10. The circuit could be controlled with a 51750 control box or a 17100 contact.

A 53750 has been inserted between the 12030 signal relay and the isolated track block, and the 53750 is triggered by the same control (51750 or 17100) as the signal drive.

When the signal is changed to "Go" (Hp1), the timer inside the 53750 is also triggered. Since power to the track block has been routed through the 53750, the train will not leave the block until the end of the timed period...or until the coffee is gone.

**Are You
an
EPL Expert?**

Here are two EPL brainteasers. Your challenge is to explain what the trains will do on each layout. Your only clues:

- Two trains operate on Layout A (above)
- One train operates on Layout B (below)

You find the answers on the bottom of this page.

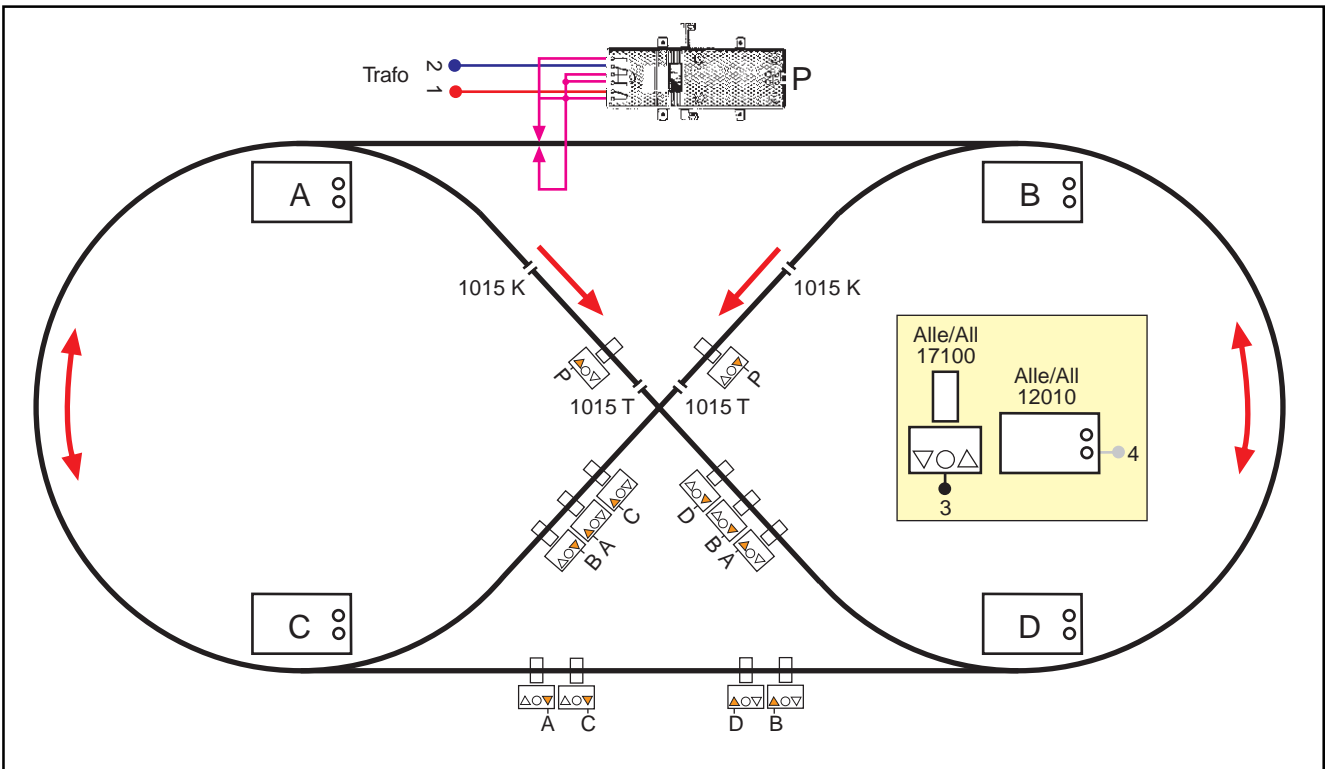
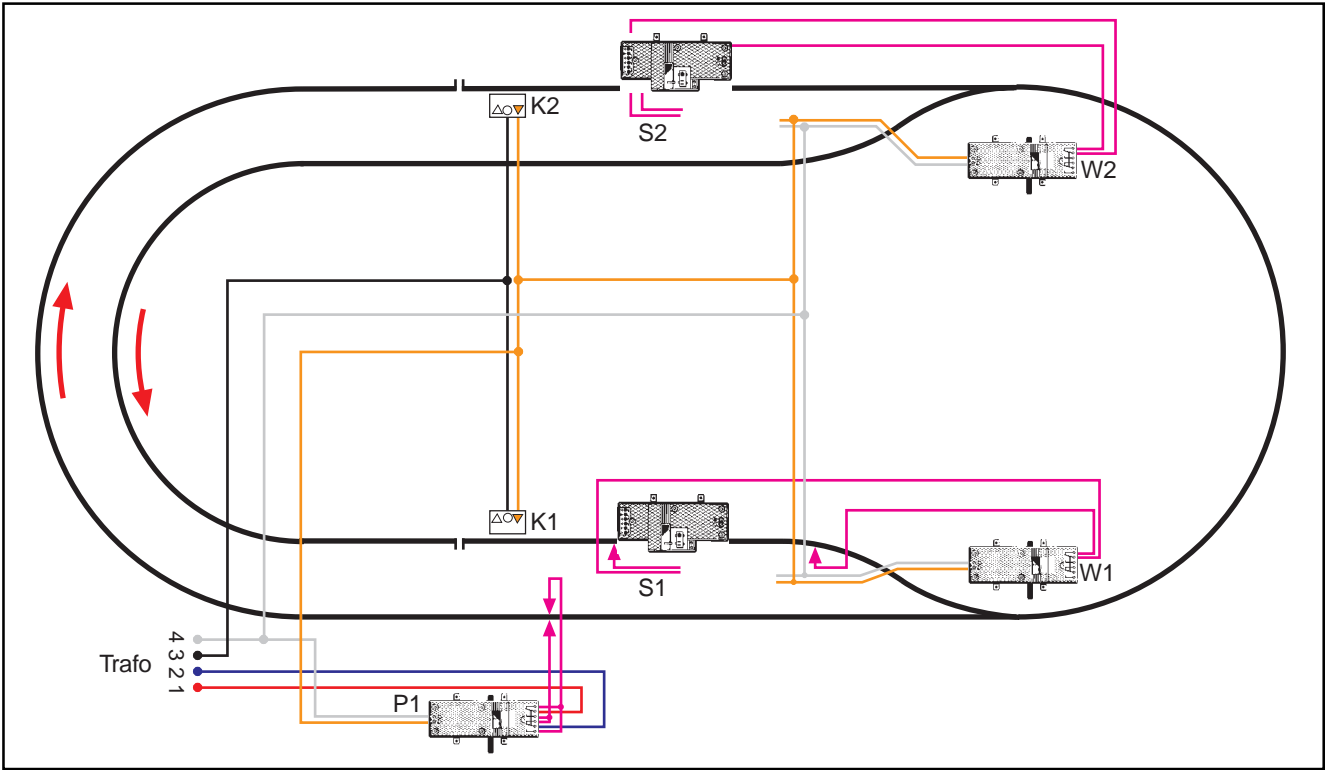

Layout A: This is similar to the Alternating Station Circuit, except the two trains alternate in opposite directions. A 12030+12010, labeled "P1," is used for track polarity control.
 Layout B: This fascinating circuit alternates the train between the outer oval and the figure-eight embedded in the oval.



CHAPTER 13: A BETTER WORLD

With LGB accessories, like overhead catenary wiring, you can make your model railroad more like a real railroad.



The LGB program includes a wide variety of accessories—from signs and figures to overhead wiring and knuckle couplers—designed to make the World of LGB an even better place. In this chapter, you'll see some special accessories, but to see the entire selection of LGB accessories, you need the latest LGB catalog, available from your local LGB retailer.

Overhead Wiring Systems

In Europe and many other parts of the world, many real railroads are "electrified." That is, electric locomotives ("E-Loks") are powered by electricity supplied through an overhead wiring system, often called a "catenary" system. The LGB program includes a wide selection of pantograph-equipped E-Loks along with two different overhead wiring systems, the "Standard" system and the "Model" system.

The "Standard" catenary system powers this classic LGB "steepie cab" loco.

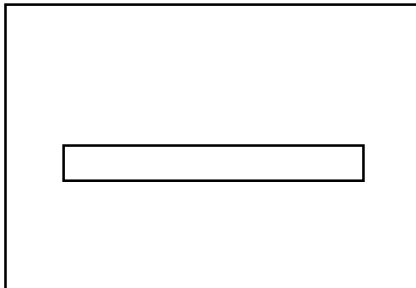
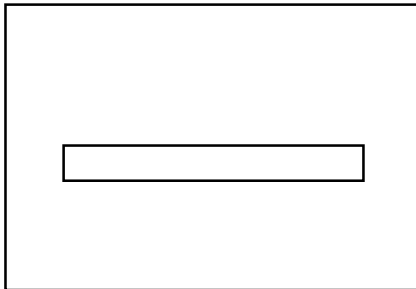

Common Components

Both LGB overhead wiring systems are made for indoor and outdoor use, and both systems share several common components:

- **56201 Catenary Wire, 12 pieces.** This stiff brass wire is the main conductor in both overhead wiring systems. It has a unique fluted profile. Each wire is 680 mm (26.8 in) long and can be cut to the required length.
- **56203 Insulated Catenary Clips, 4 pieces** (not shown). These plastic clips make an insulated connection between 56201 Catenary Wires.
- **56204 Catenary Clips, 12 pieces.** These metal clips make an electrical connection between 56201 Catenary Wires.

Standard Overhead Wiring System

The LGB "Standard" system is modeled after the simple overhead wiring systems found on street car and short lines. It is suited to relatively flat layouts, and it is very easy to install. The components of the Standard system are:

- **56400 Standard Catenary Mast.** This basic mast has a single arm to hold a catenary wire over a single track.
- **56401 Standard Catenary Mast, Wired.** This mast is the same as the 56400 except it has a feeder wire for connecting the catenary wire to a power supply.
- **56402 Standard Catenary Mast Arm.** With this additional arm, a 56400 or 56401 mast can be used on a double-track line.

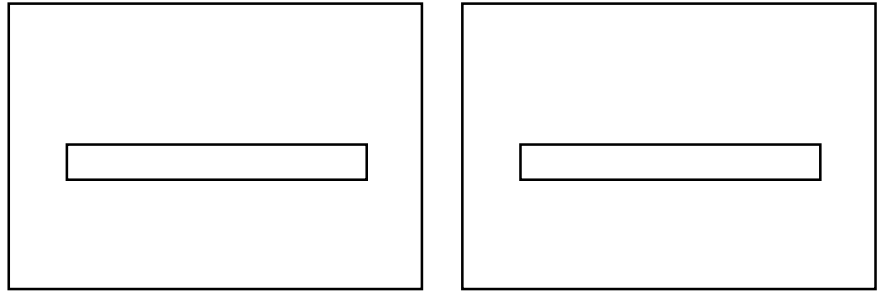

The Standard masts (56400 and 56401) have a fixed clip for attaching the mast to the track. For extra clearance on curved and complex track sections, the clip can be removed with a razor saw, and then, the mast can be attached to the layout with a screw.

On dead-end track sections, the arm can be removed from the mast, and the catenary wire can be attached directly to the mast.

Model Overhead Wiring System

The LGB "Model" system is modeled after the sophisticated overhead wiring systems found on modern Swiss railways. It features two wires: a catenary wire and a support wire. The catenary wire hangs from the support wire much like a highway hangs from the support cables of a suspension bridge.

The "Model" overhead wiring system captures the beauty of Swiss railroading.





The Model system can be used on all types of layouts, including steep cog railways. The components of the Model system are:

- **56200 Model Catenary Mast.** This mast (left) features a solid aluminum post and includes two arms: one to hold the catenary wire and one to hold the support wire.

- **56202 Catenary Support Wire, 12 pieces.** This wire is 680 mm (26.8 in) long. Each support wire includes seven hangers to hold the catenary wire.

- **56300 Model Catenary Mast, Tilttable.** This mast is the same as the 56200 except it has an adjustable base to accommodate grades up to 25° on rack railways.

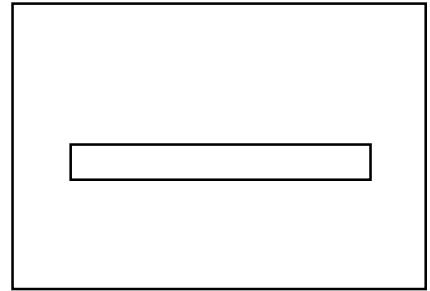
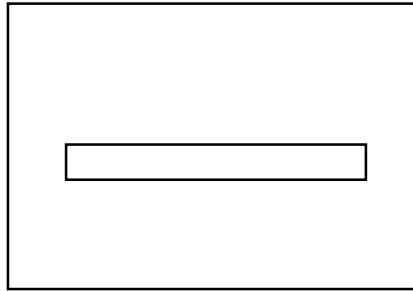

The Model masts (56200 and 56300) have an adjustable clip (5.5-30 mm) for attaching the mast to the track. A power supply can be connected to any Model mast by attaching a wire to the screw on the base of the mast.

Installing Overhead Wiring

Installing an overhead wiring system requires some experimentation. Here are some hints:

- The catenary wire does not have to be positioned exactly over the center of the track. However, it should be kept between the rails.

Hint: In fact, it's helpful to "zig-zag" the catenary wire to spread the wear on the locomotive pantograph.

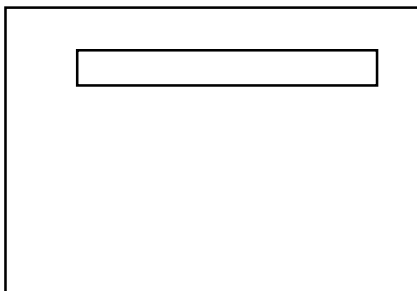
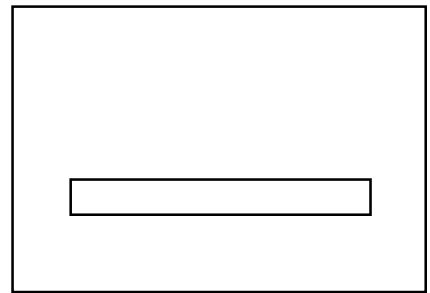
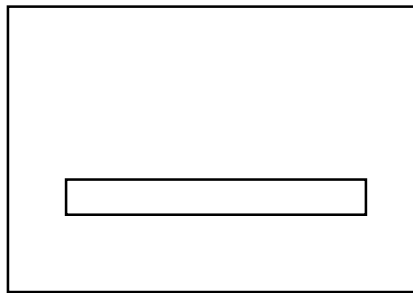

- Catenary clips (56203 and 56204) can be used to create complex wire junctions at switches and crossings.

- Use a sharp cutting tool to cut the wires. Clean the cut with a fine-toothed file.

- Check clearances carefully, especially on curves, to make sure the masts do not interfere with train traffic.

Powered or Unpowered?

With both LGB overhead wiring systems, you can choose whether the system is "powered" or "unpowered." A powered overhead system supplies electricity through the overhead wires, just like a real overhead wiring system. An unpowered system offers the same realistic appearance, but without electricity.

With a powered overhead wiring system, it is possible to operate two trains independently on the same track at the same time. This was an important feature at one time, before the introduction of the LGB Multi-Train System. However, with the Multi-Train System you can operate up to eight trains on the same track at the same time, and we now recommend the Multi-Train System for multiple-train operation.

Attention! Do not use a powered catenary system together with the LGB Multi-Train System on the same layout. A short circuit between the track and the catenary could produce a dangerous high voltage.

Of course, you can use an unpowered overhead wiring system on any layout, including Multi-Train System layouts.

Powered Overhead Wiring

LGB E-Loks are equipped with special metal frames, called pantographs, to pick up electricity from overhead wiring systems. Unless it is equipped with a Multi-Train System Decoder, an LGB E-Lok can be operated using either track power or overhead power. You can choose track or overhead power with a power control switch on the locomotive.

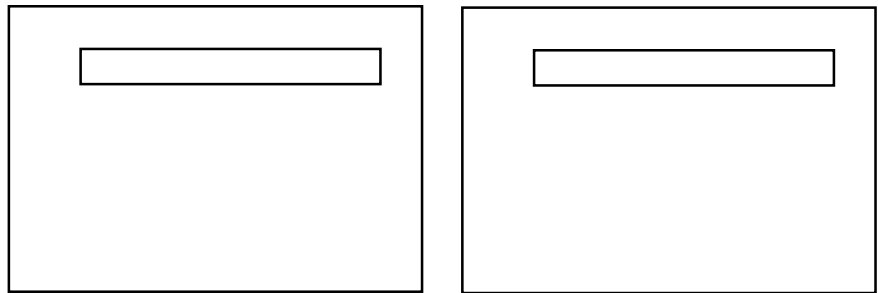

With the switch set for overhead power, the wheels on one side of the locomotive are disconnected from the power circuit. (That side is indicated with a red dot on the bottom of the locomotive.) Instead, power is transmitted from the power pack to the overhead wire, through the locomotive and through the ground rail (M) to the power pack. The traction rim rail (H) is not connected to power.

With a powered overhead wiring system, you can operate a second locomotive independently on the same track using a second power pack connected only to the track. The second locomotive can be an LGB steam or diesel locomotive, or it can be an LGB E-Lok with the power control switch set for track power.

Hint: The overhead powered E-Lok must be placed on the track with the disconnected "red dot" wheels on the traction rim rail. If the E-Lok does not work properly, turn the loco so that the wheels are on the opposite side.

Coupling...

The LGB program includes two different types of couplers:

- **Hook-and-Loop Couplers.** These popular couplers are standard equipment on most LGB trains. They use a spring-loaded "hook" on one car to capture a "loop" on the next car.

- **Knuckle Couplers.** These authentic American-style couplers can be retrofitted to many LGB locomotives and four-axle cars. Identical couplers on each car grasp each other like the fingers of two hands.

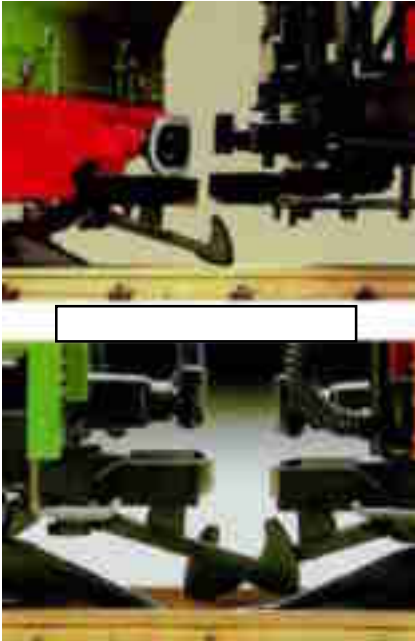

Standard Hook-and-Loop Couplers

Standard LGB hook-and-loop couplers are simple and reliable, and as a result, they are the most popular G-scale coupler in the world.

Most LGB cars and locomotives are equipped with "asymmetrical" hook-and-loop couplers at the factory. Asymmetrical means that there are "loops" on both ends of the car (or loco), but there is a "hook" on only one end of the car (above left). This arrangement simplifies uncoupling since only one hook needs to be retracted to uncouple the cars. However, this can cause a bit of confusion when switching cars.

The solution is to add a second hook to the car, making the couplers "symmetrical" (middle left). With this "double-hooked" arrangement, it does not matter which direction the ends of the cars are pointed. Also, symmetrical couplers are more reliable on rough trackwork. Most LGB cars are shipped with the parts required for the symmetrical conversion. The parts are also available separately as the 64402 Coupler Hook Set.

Knuckle Couplers

LGB's optional 64192 American Knuckle Coupler is a fully functional replica of an authentic American knuckle coupler.

The 64192 can be easily retrofitted to many LGB locomotives and to most American-prototype, four-axle cars built after 1980. (The 64192 cannot be easily fitted to

most European-prototype or two-axle cars.) The standard hook-and-loop coupler can be removed from the car by removing a screw. Use the same screw to attach the knuckle coupler to the car.

The 64192 has a spring loaded "knuckle" mechanism. When two couplers are brought together, the mechanisms on both couplers close, latching the cars securely to each other. Remember, however, that LGB knuckle couplers will not mate with standard hook-and-loop couplers.



...and Uncoupling

There are three convenient ways to uncouple LGB couplers:

- **By hand.** For hook-and-loop couplers, use a thin tool, like a metal ruler or tongue depressor, to press down between the loops to release the hooks. For knuckle couplers, use the same tool to press up on the release lever under the couplers.

- **10520 Manual Uncoupler.** This small device is designed for hook-and-loop couplers only. It fits between the rails of LGB straight track sections.



To uncouple, stop the car with the coupler over the 10520, allowing some slack (see photo Page 173). Then slowly pull the cars apart. If symmetrical couplers are installed, two 10520s should be installed together.

- **10560 Electric Uncoupler.** This device is built into a 150 mm straight track section, and it is controlled with a 51750 Momentary Control Box. The 10560 can be used with both hook-and-loop and knuckle couplers.

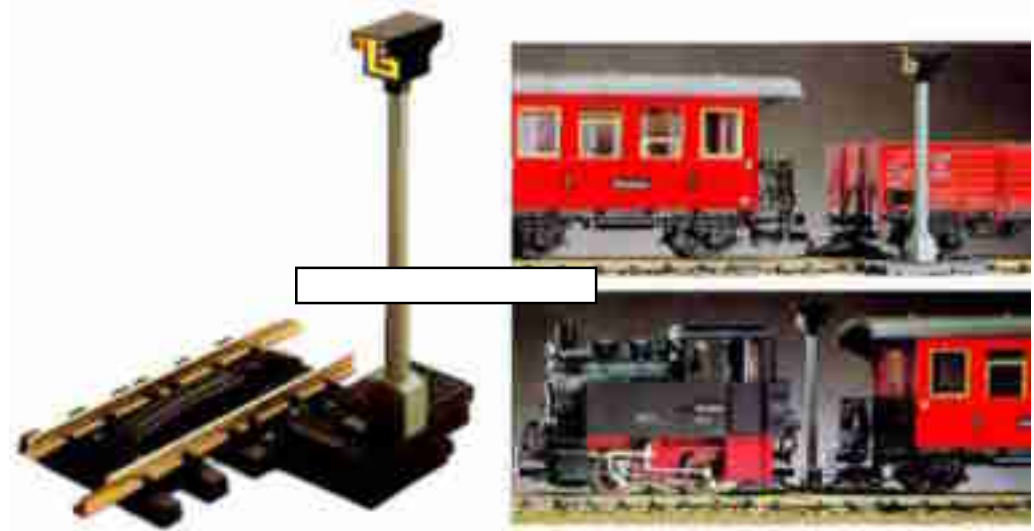

To uncouple, stop the car with the coupler over the uncoupling ramp on the 10560. Press the button on the 51750, and slowly pull the cars apart. If symmetrical hook-and-loop couplers are installed, a 10520 Manual Uncoupler should be installed together with the 10560.

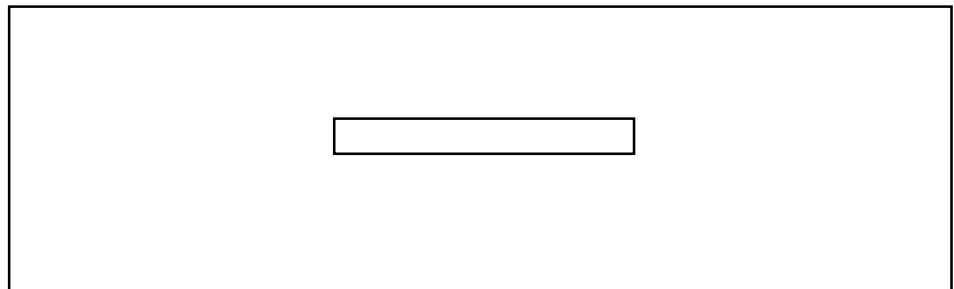

Hint: A 12030 Supplementary Switch can be installed on a 10560. The 12030 can be used to turn the "E" light on the 10560 on when the uncoupling ramp is up.

Special Accessories

Here are some special tips for some special LGB accessories:

10154 Activation Track

The 10154 Activation Track is used to operate special LGB "action" cars, like the 40560 Hot Metal Unloading Car.

The 10154 is controlled with a 51750 Momentary Control Box [Catalog 165-top]. To operate the action car, stop the car in the center of the 10154 and press the button on the 51750.

Hint: If the car is not centered on the 10154 Activation Track, the car may not operate and may cause a short circuit.

50340 Station Platforms

With these platforms, you can create level areas around LGB tracks for passenger stations and freight loading.

With LGB platform accessories, you can create a realistic streetcar stop.



The 50340 set includes twelve platform sections: four narrow and eight wide. The narrow sections are 300 mm long and are designed to fit between the rails of LGB straight track sections. The wide sections are also 300 mm long but are designed to fit outside the rails.

The narrow sections fit between the rails. The wide sections latch to the track and to each other. The sections are designed to fit tracks with 165 mm spacing, but they can also be used with 185 mm and 200 mm spacing. The sections can be cut to fit curved sections.

The 50340 set includes instructions for fitting other LGB accessories, like the catenary masts, to the platforms. The 50330 Transit Stop Set, which includes signs and benches, is made for use with LGB platforms.

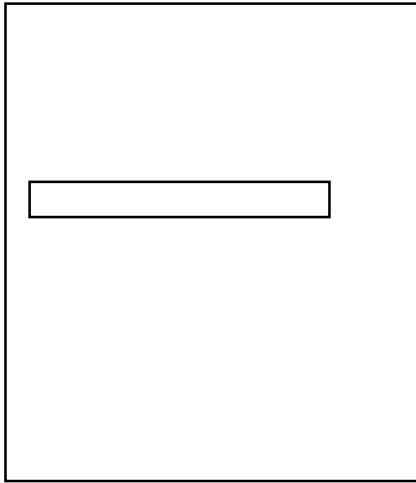

These signs tell the engineer to sound the whistle and obey a 15 kph speed limit.

European Railway Signs

Track signs are absolutely essential for safe railroad operation. Many of the signs used on prototype European railways are included in these two LGB sign assortments. Both assortments include posts and removable base plates:

- **50310 European Track Signs.** Contains signals and signs for controlling railroad traffic, including grade, snow plow, switching, slow signals and more.

- **50320 European Warning Signs.** Contains railroad signal boards and warning boards for road traffic, including grade crossing signs.

The 50310 set includes the following signals and signs:

- 1 LP 5 Stop bell
- 2 LP 3/Lf 4/LP 4 . Sound bell and whistle (LP 3), 15 km/hour speed limit (Lf 4) and continue bell until LP 5 signal is reached (LP 4)
- 3 LP 1/Lf 4 Sound whistle (LP 1), 15 km/hour speed limit (Lf 4)
- 4 LP 1/Lf 4 Sound whistle (LP 1), 15 km/hour speed limit (Lf 4) and repetition mark (board is repeated after station)
- 5 Ne 4 Signal is not located to the right of or over the track
- 6 Ne 9 Grade crossing approaching
- 7 Ne 2 Substitute for Vr2 distant signal (50910)
- 8 Zs3 (DR) Home signal (Hp) does not apply to switching maneuvers
- 9 Ne 7 Raise (a) or lower (b) snow plow at grade crossing
- 10 Ra 10 Switching maneuvers allowed up to this point.
- 11 Ne 12 Change-of-grade board: up grade more than 0.7% (a) or down grade more than 0.7% (b)
- 12 Lf 3 End of speed limit
- 13 Lf 5 Beginning of speed limit
- 14 Lf 4 Speed limit (3 = 30 km/hour, 1.5 = 15 km/hour)
- 15 Lf 4 Speed limit (for use on ground, instead of post)
- 16 Instruction and prohibition signs

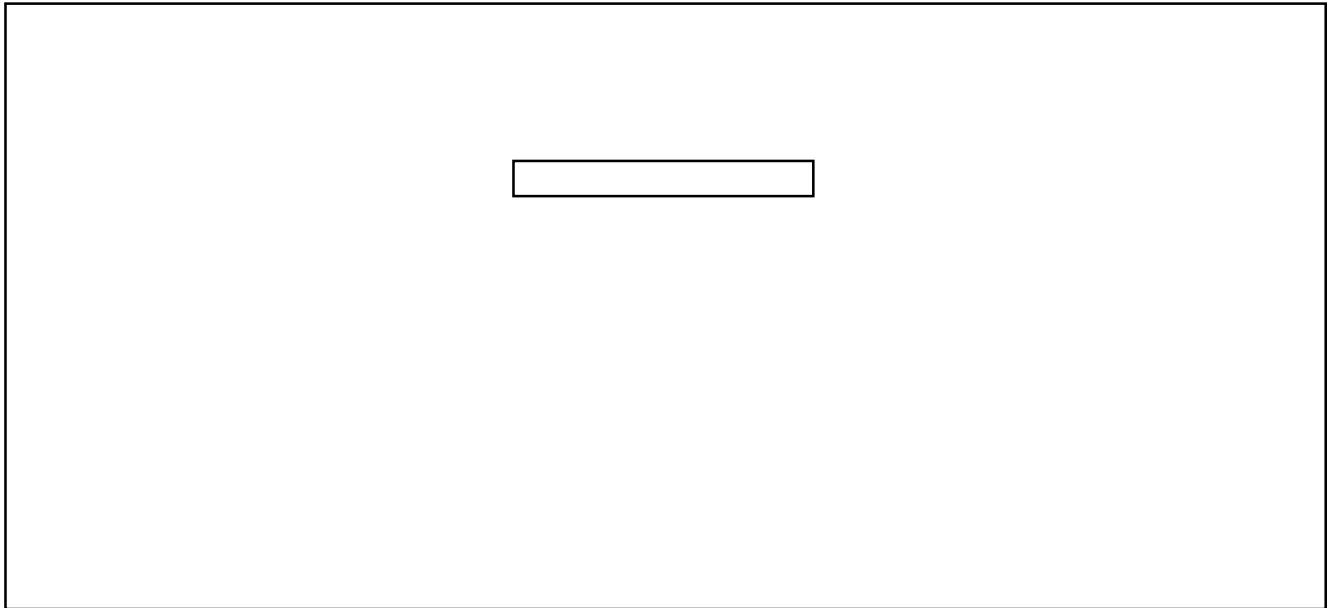

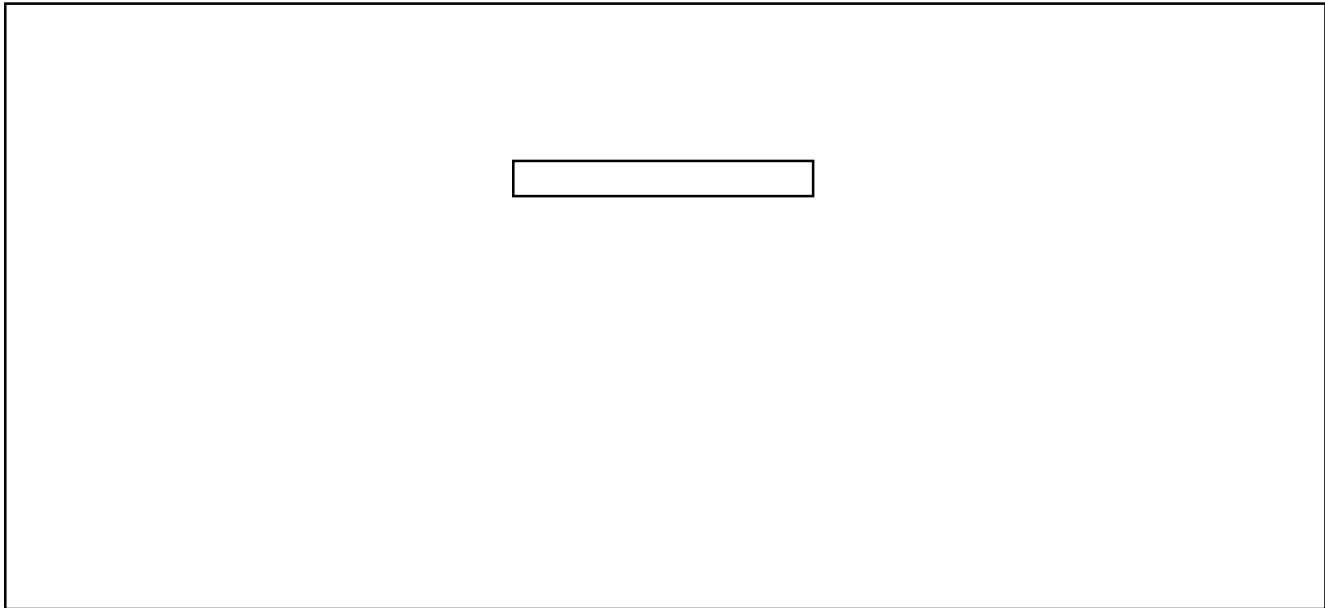

The 50320 set includes:

Auto Road Signs

17 Gate-equipped grade crossings (up to 1961)

18 Gate-equipped grade crossings (after 1961)

19 Grade crossing without gates

Railroad Signs

20 LP 1 Sound whistle

21 LP 2 Sound bell

22 LP 3 Sound bell and whistle

23 LP 3/Lf 4 Sound bell and whistle (LP 3), 10 km/hour speed limit (Lf 4)

24 Ne 5 Front of scheduled train stops here

25 Sh 2 Stop, do not use track under any circumstances

26 Ne 1 Trapezoid post, placed on secondary lines to indicate a station without an entrance signal

27 Ne 6 Station ahead, placed horizontally at an angle to the track

28 K 16 Warning signal for switching areas, secondary lines, etc. (up to 1946)

29 Zg 4 End-of-train disk (daytime) for locomotives traveling alone, short freight trains, work trains, etc..

Overhead Wiring Signs

All of these signs are mounted diagonally on posts or overhead masts.

30 "Head of train stops here"

31 El 2 Switch on loco

32 El 6 End of overhead wire

33 El 1 Switch off loco

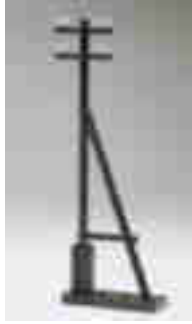

Telegraph Poles

The LGB program includes two different types of telegraph (or telephone) poles. The 50350 Telegraph Pole is a basic straight pole. The 50360 is an offset pole with a side support for mounting near curved track sections.

Street Lights

The LGB program includes a variety of street lights, like the 50500 Street Light and 50550 Station Light. LGB street lights operate on 18 volts AC or DC (maximum). You can wire them to an LGB AC power supply (see Chapter 7). If you have an extra starter set power pack, you can wire street lights to its DC output terminals and use the power pack throttle to adjust the brightness of the lights.

Hints:

- Using a lower voltage will extend the life of the light bulbs.
- Street lights can be controlled with EPL components, like a 51800 On/Off Control Box or 12010/12030 relay.

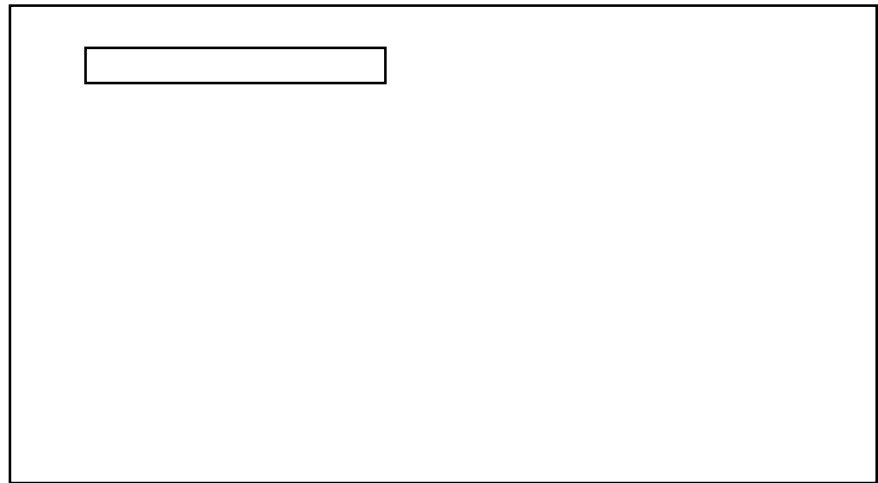

- LGB street lights include base spikes for temporary or permanent mounting in a lawn or garden.
- Each street light bulb requires about 50 milliamps of power. So 20 bulbs require 1 amp (20 x 50 milliamps = 1000 milliamps = 1 amp) Make sure your power supply provides adequate power for all your accessories.

LGB Q&A

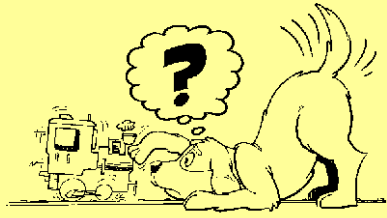

The 68333 Interior Lighting Set (left) and 58334 Light Socket Adapter (right)

How can I add lights to my train?

The 68333 Interior Lighting Set can be installed in most LGB passenger cars. Remove the roof of the car, and look for the mounting points molded into the underside of the roof. Attach the light to the mounting points with screws. (Longer cars may require two lighting sets.)

Extend the cables from the light through the slots in the ends of the car. Reinstall the roof. Insert the plug on the end of the cable into the multi-purpose socket on the back of most LGB locomotives.



Hint: The 68333 lighting set is equipped with reliable "flat" plugs. If your LGB loco is equipped with older "round" multi-purpose sockets, use the 68334 Light Socket Adapter.

If you don't want to connect the car to the loco, you can connect the lights directly to track power by installing 67403 Ball Bearing Wheel Sets, which feature built-in electrical pickups. These instructions apply to many installations:

- Replace at least one standard wheel set with a 67403 Ball Bearing Wheel Set. (Your lights will operate more reliably if you use two 67403 sets.) On most LGB models, you can gently bend the sides of the truck to remove the old wheel set.
- Cut the plug from one end of the cable.
- Strip about 4 mm (0.2 in) of insulation from the end of each wire.
- Crimp wire connectors (included with the 67403) on the end of each wire.
- If necessary, drill access holes through or near the center pivot of the truck with the ball bearing wheel set. Be careful not to damage the interior of the car.
- Route the modified cable through the hole.
- Plug the wire connectors into the pins on the 67403.

Attention: Avoid short circuits. If you are using more than one 67403, make sure all the connections have the same polarity. Also, make sure the pins on the 67403 do not touch the rails or other metal objects.

Also, the LGB program includes two styles of lanterns for the last car of your train: 68331 European Train Lantern and 68332 American Train Lantern. The 68332 includes a bulb and socket, but the 68331 does not. If you want the 68331 to operate, use the 68502 Screw Bulb Socket.

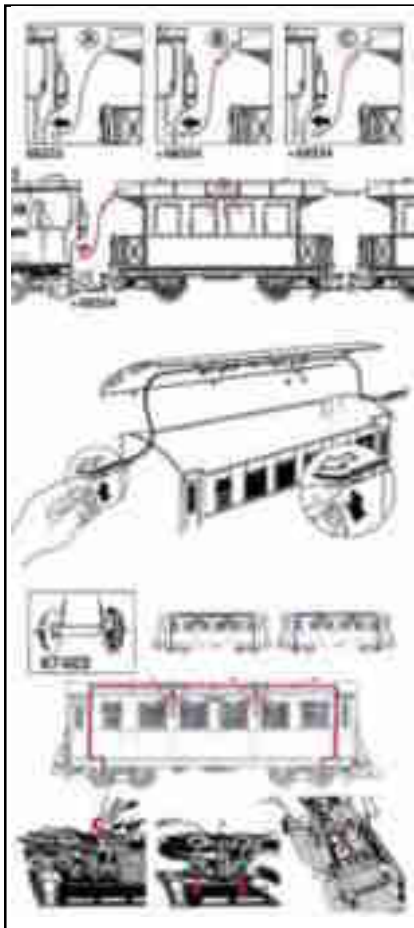

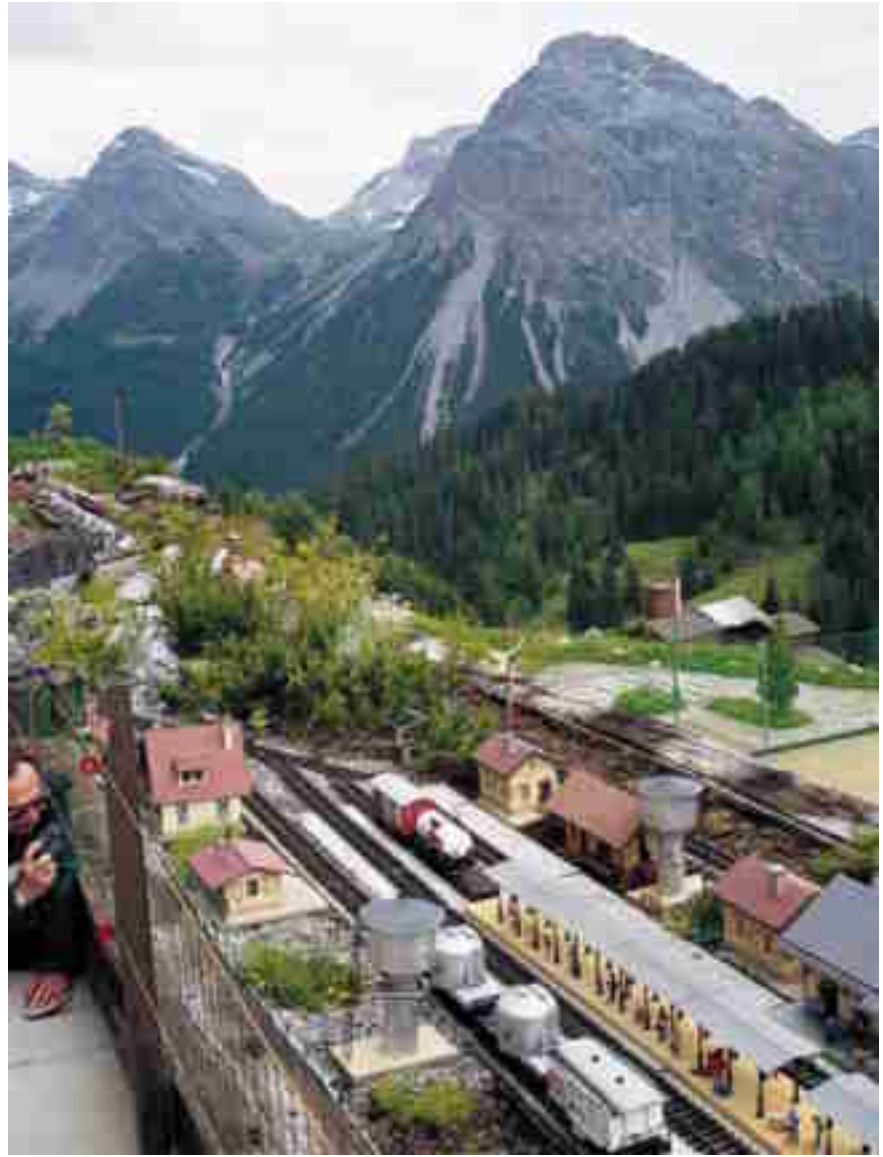

CHAPTER 14: THINK BIG!

A spectacular setting deserves a spectacular layout, like this one at a Swiss hotel.

There are many impressive model railroads in many scales, but no other model railroad is as magnificent as a large LGB layout. There are no little trains with little details. There are big locomotives making big sounds pulling big trains on big tracks crossing big bridges between big stations. It is the difference between a band and a symphony, between a flower and a garden.

In this chapter, you'll see large LGB layouts from around the world, and hopefully, you'll be inspired to build your own.

Winding Up the Mountain

Edwin Herkner's pike had to be located on a slope in his garden, and so he designed a winding layout with a bold route.

The end points of the layout are separated by an incredible difference in elevation of 2.54 meters (8.3 feet). The "Lichtenberg-Grubstädter-Bahn" is 70 meters (230 feet) long and is built mainly with R2 radius curved sections.

Using curves, bridges and racks, you can build a large layout on a steep slope.

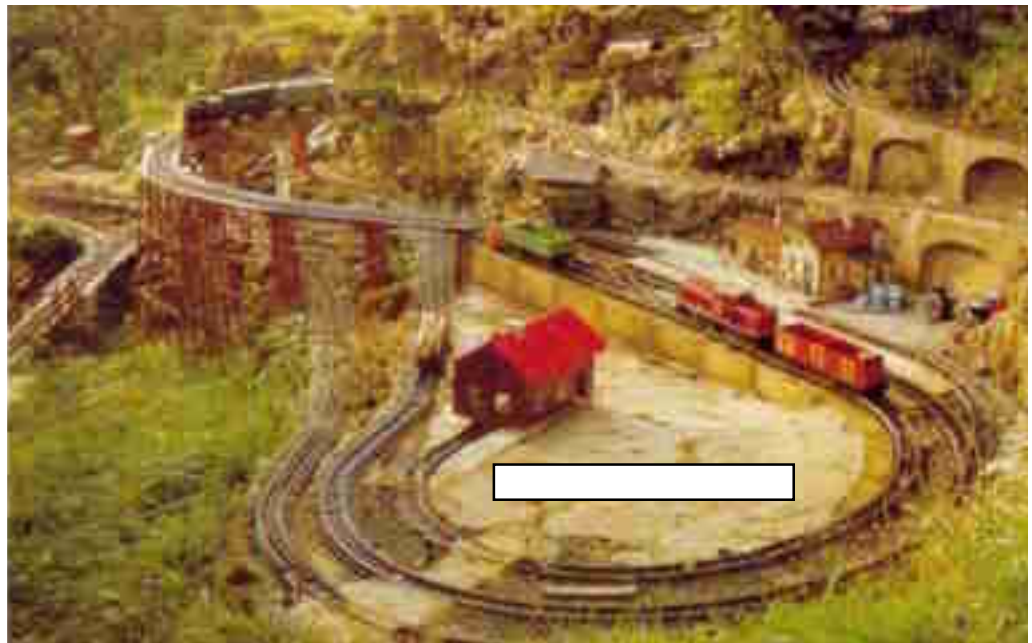

From the Lichtenberg station (B), the line leads to the highest point on the line, a sawmill (S) on the upper reversing loop. In the other direction, along a steep slope, it curves over a high wooden bridge down to the Waldau station (C). From here, the railway descends at a steady downhill grade of 3.5% past the gravel plant to the Grubstadt station (D) in the lower reversing loop.



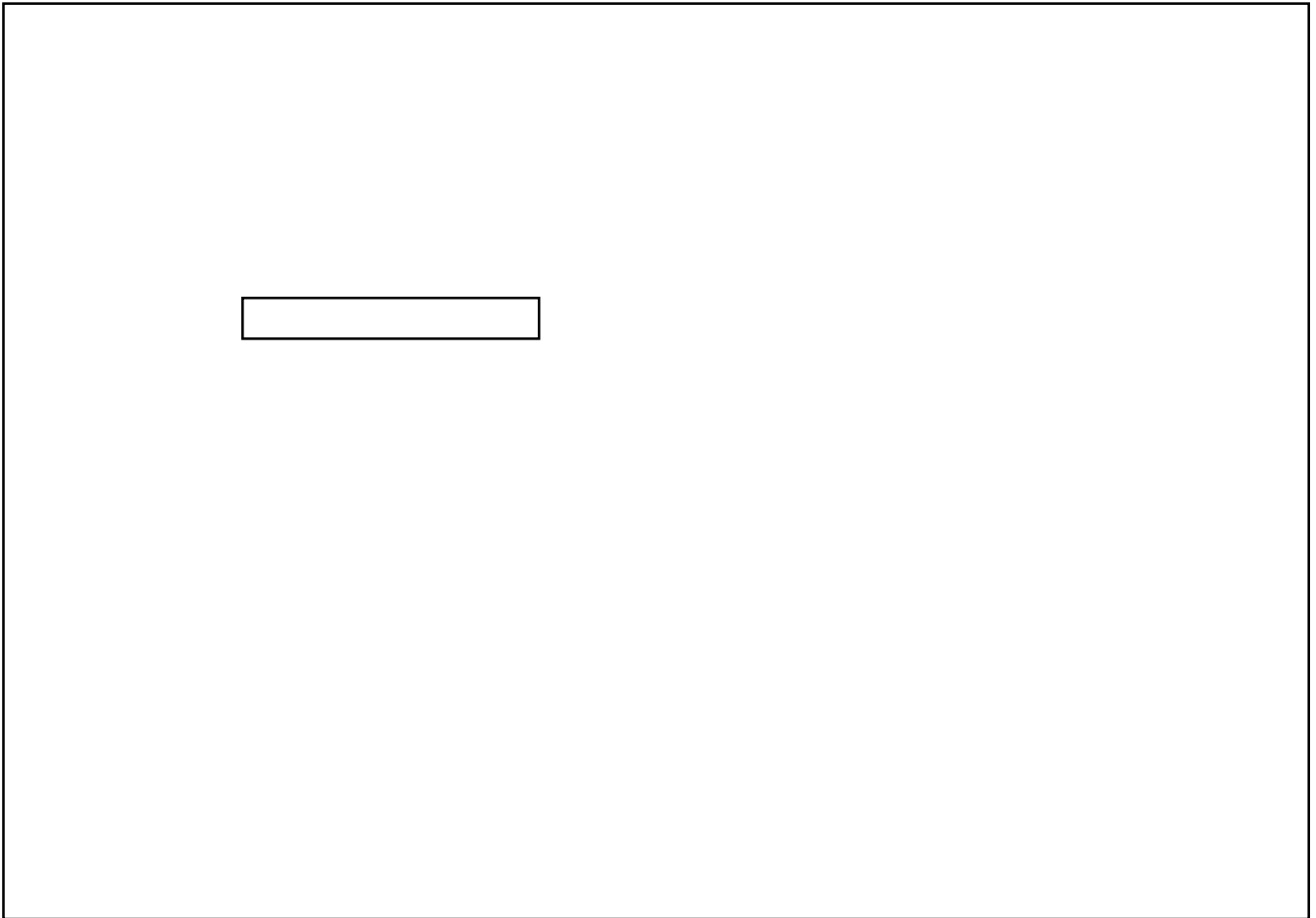

The two cog railway sections are a unique feature: The upper section descends on a 7% grade past the Grubstadt station and a mine to the lowest point on the layout (E). Although the cog lines are an interesting part of the layout, most of the railway can be traversed by conventional "adhesion" locomotives.



Under Roof

Large LGB layouts can also be indoor LGB layouts. For example, Hubert Dieregswiler built a very impressive LGB layout in his remodeled 92 square meter (990 sq ft) attic.

Five main power blocks permit realistic train operation. The continuous outer loop and the Filisur station consist of two blocks: Block I for the rails and Block II for the catenary wire. The entire Vinn station yard (blue) uses Block III for the rails. Here, about two-thirds of the trackage is equipped with an overhead wire: Block IV.

The branch line (yellow), Block V, starts at the Vinn station, leads through an industrial area with a refinery and continues on to the Schwafheim terminal station of a small branch line.

Without a doubt, the center of operations for electric locomotives is the Filisur station, loosely patterned after the station of the same name on the



Rhätische Bahn's Albula line. On the other hand, steam and diesel engines use the Vinn station as their home base and are stored there. The out-bound tracks from the stations are marked by arrows on the plan.

Lots of busy running and switching work can be done on the entire layout, which includes a large number of uncoupling tracks. The main line (black) is equipped with an overhead wire.

All the main line tracks, the through-routes in stations and the turnouts were created with large R3 curves. This looks more natural when a train with large locomotives and long cars runs through curves and sets of switches. R1 switches are used only in those areas of the Vinn and Schwafheim stations and the Lauersfort industrial area that are dedicated solely to switching and storage. Wood buildings are used exclusively on the entire pike, since this fits in better with the wooden construction of the attic floor.

The layout has three stations and an industrial spur:

- The Vinn station, with its switching and storage capabilities and its repair yard, is the largest station, two-thirds of which is equipped with overhead wire. The branch line to Schwafheim via Lauersfort starts here.
- The Schwafheim station is the terminus of the branch line. Automatic uncouplers and spring-loaded switches permit automatic repositioning of locomotives on the main inbound track.
- The Lauersfort stop is used only as needed for passenger service. Switching can be done here for the industrial spurs leading to a small refinery, lumber storage yard and a bulk materials silo.
- Filisur station and the outer circle of track are completely equipped with overhead wiring. All switches and uncoupling functions are operated from a central control panel. The EPL system permits several trains to be operated on each main block. All wiring is located under the platforms and behind the floor moldings.

Filisur station (below) consists of four main tracks and dominates the setting. Like the original, it is connected to a single-track main line and is equipped with catenary power.



Details give this layout a realistic feel in an unrealistic indoor setting.



At Lauersfort station, a passenger train waits on the branch line. Beside it, one can see a chemical plant spur with a tank car loading station. In accordance with regulations, the loading station is identified as being a temporarily closed or protected area using a warning signal from the 50320 Warning Sign Set.

Available Space

By building your layout along natural boundaries, like fences and sidewalks, you can build a large layout without using a large space.

Siegfried Ade has been an LGB fan since 1975, and in 1981, he began to build a garden layout. It has 17 switches, 10 signals and about 90 meters (295 feet) of track. However, the layout does not fill his yard. Everything is built around the edges. So you can still walk and rest and enjoy the lawn.

No, the plants aren't to scale. But they're beautiful, aren't they?



This layout wraps around the edges and open corners of a garden.

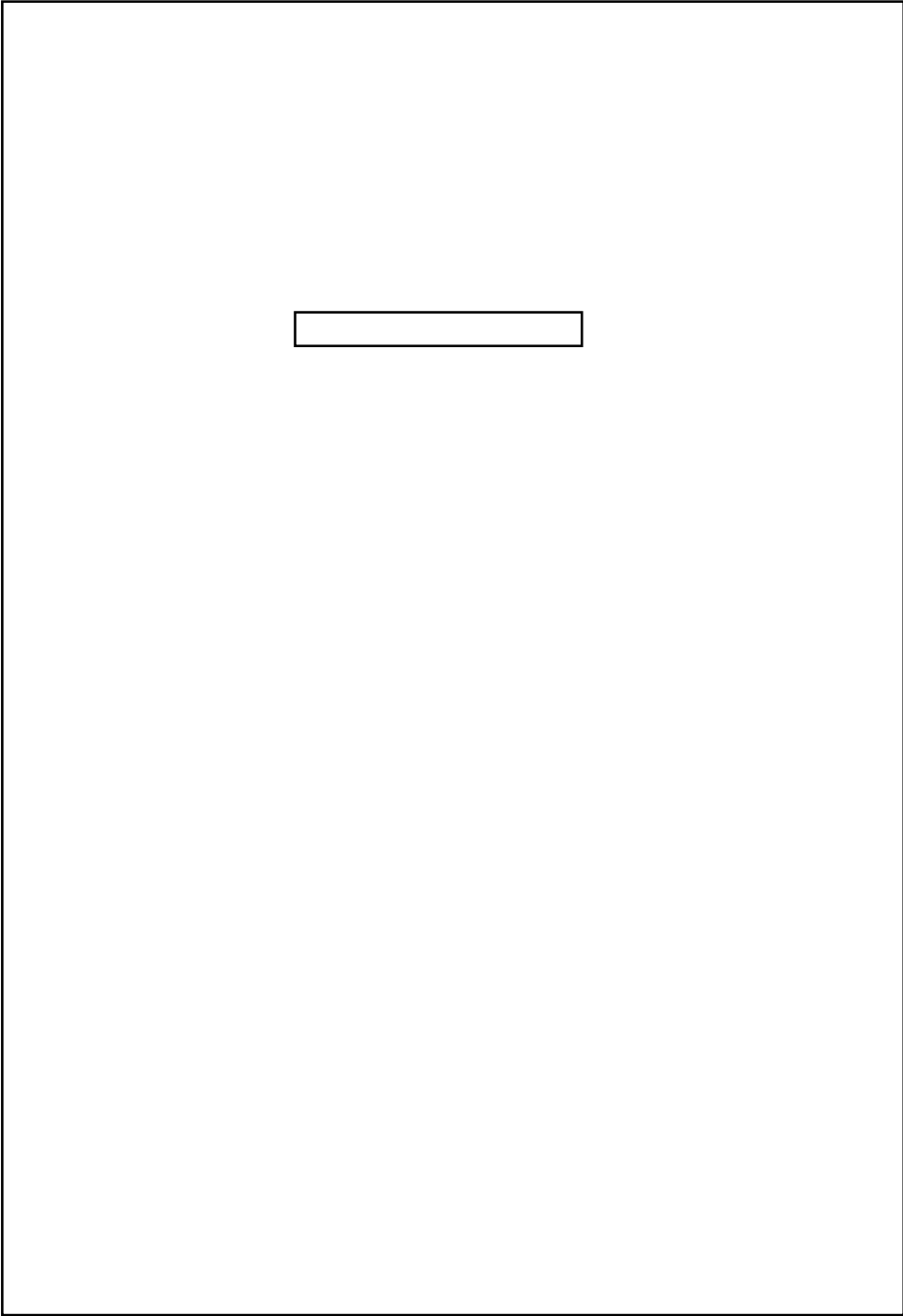

A total of 25 tractive units (locomotives and railcars), 36 passenger cars and 42 freight cars are available for widely diverse operations. Power is supplied to the speed controls by four transformers, located on the ground floor of the adjoining home. Water is pumped from the lower pond to the mill by a 12-volt centrifugal pump.

Working Together

Story by Max Wyss

The St. Gallen layout is basically a folded figure-eight. Construction began in 1977.



LGB fans from all over the world make pilgrimages to the LGB layout of the St. Gallen LGB Club, located northwest of St. Gallen, Switzerland.

The club layout is one of the largest outdoor layouts in Europe, allowing 12 trains to operate simultaneously. About 1000 meters (3280 feet) of track have been laid in an area that measures nearly 700 square meters (2300 sq ft). Normally the layout operates fully automatically: dropping a one-franc coin in a meter runs the trains for about 2 1/2 minutes, roughly the time it takes a train to travel the entire line.

History

The whole thing started in 1976 when the St. Gallen LGB Club was founded. The club's goal was (and still is) to build and operate an LGB outdoor layout. The problem of location was solved very quickly, since the owner of the Schiltacker Restaurant wanted to create an

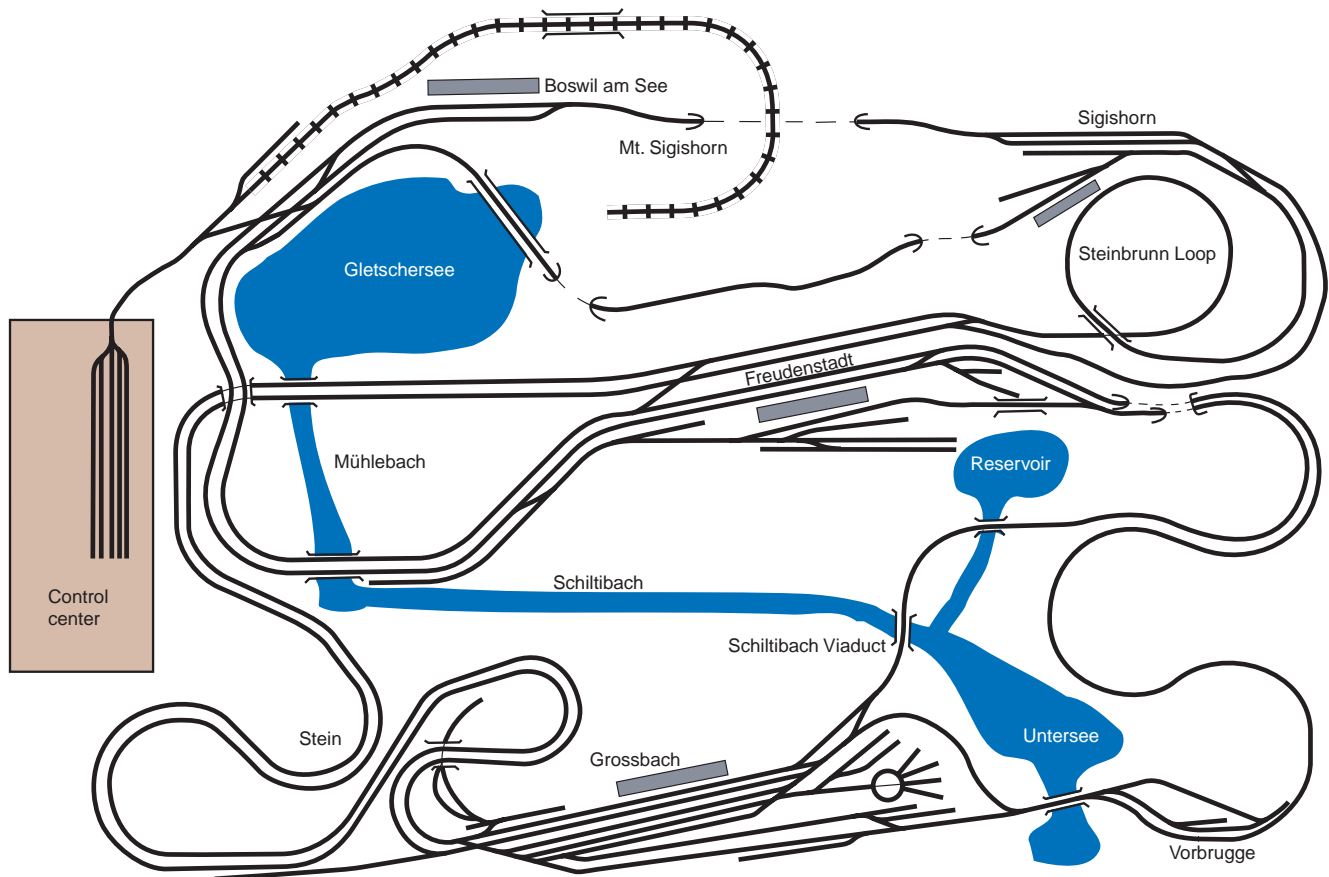



Just drop a coin in the meter and you can watch the trains run all over the layout.

amusement park. He liked the idea of the model railroad layout and offered the club space to build it.

Construction got under way in 1977 and operation began in the summer of 1979. The line was single-tracked and enabled as many as six trains to operate fully automatically. Relay-controlled block signals prevented accidents at sidings at the five stations.

A clubhouse was built adjacent to the layout to store tools; it was later used to house the trains and electrical equipment. Subsequently, the clubhouse was expanded to serve as a lounge. It is linked to the layout by a spur; the trains are assembled in the clubhouse and stored there overnight.

It was soon obvious that six trains did not offer enough action for the average park visitor. There was no logical way to increase the number of stations, but double-tracking the layout proved to be the right answer.

Running a maximum of twelve trains provides a lot more to see, but usually only nine trains operate at any one time. This permits expresses to pass certain stations. The cog railway on the mountain, as well as the Rigi cable cars, makes the layout even more attractive.

Operation

Since maintaining the layout costs much more than feeding one-franc coins to the meter can provide, it wasn't long before sponsors had to be found. The fence around the layout was lined with paid advertising, and some cars carry paid advertising.

The layout normally operates fully automatically, but there are chances to play on days when there are enough club members around. This is also a treat for the public, since no one has to pay money to make the trains run!

Still, every coin is welcome, and the tendency is not to "play" when the weather is nice for customers. Sometimes the urge gets too strong, though, and strange things can happen.

There was the time, for example, one member had recently become the proud owner of a remote-controlled fire truck. So he had the idea of setting fire to an old wooden model building and then simulating the fire department putting out the blaze. And that is just what he did: set the house afire and "call the fire department." A bucket of water made it possible to do the whole thing over and over.

When the layout commences operation for the season at Easter, there can be surprises. One year, everything was normal on Saturday and you could work in your T-shirt and shorts; then about 200 mm (8 in) of snow fell on Saturday night. This offered the members a chance to do some snowplowing before the white stuff vanished in the afternoon.

A Big Conversion

*Story and Photos by
Michael Adamson*

It was in 1981 that I finally decided that 4 mm (British HO) scale was not for me. I had been operating a 4 mm line in a room at the rear of my garage for some time, but in January of that year I attended a Gauge 1 meeting and came away captivated with what I saw. So I changed gauges and bought 35 yards of track to make an oval arrangement in my back garden.

While working in Gauge 1, however, I had purchased a secondhand LGB diesel plus two trucks for the princely sum of £40.00. My idea was to use these to test the newly laid track and eventually use the chassis for a G.W.R. railcar. I was very impressed with the overall performance of the diesel. Its quietness and smooth pick-up outdoors was noticeable, especially as my Märklin locomotive left a lot to be desired in this respect. So the seeds of discontent were already sown when I read an article in *Continental Modeler* by John Heywood on building a Rhodesian Railways 14A Beyer Garratt using two LGB chassis.

The Switch to LGB

After long deliberation, I decided that this was the solution to my problems. I would change over to LGB and build overseas British prototypes, with a distinct emphasis on African. Furthermore, this would give me a complete break from English outline modelling, which had lost a certain individuality over the last ten years and was becoming commonplace.

For me, the LGB scale/gauge combination has been the answer to my problems. A complete range of proprietary models and equipment is available together with a range of parts to allow the modeler the option of conversions or scratchbuilding. This means that the drudgery of making chassis and valve gear, as well as searching for gears and motors, has been eliminated. With the reliability of LGB products, faultless working is assured.

Son Matthew poses with the Adamson's first LGB diesel in 1982.



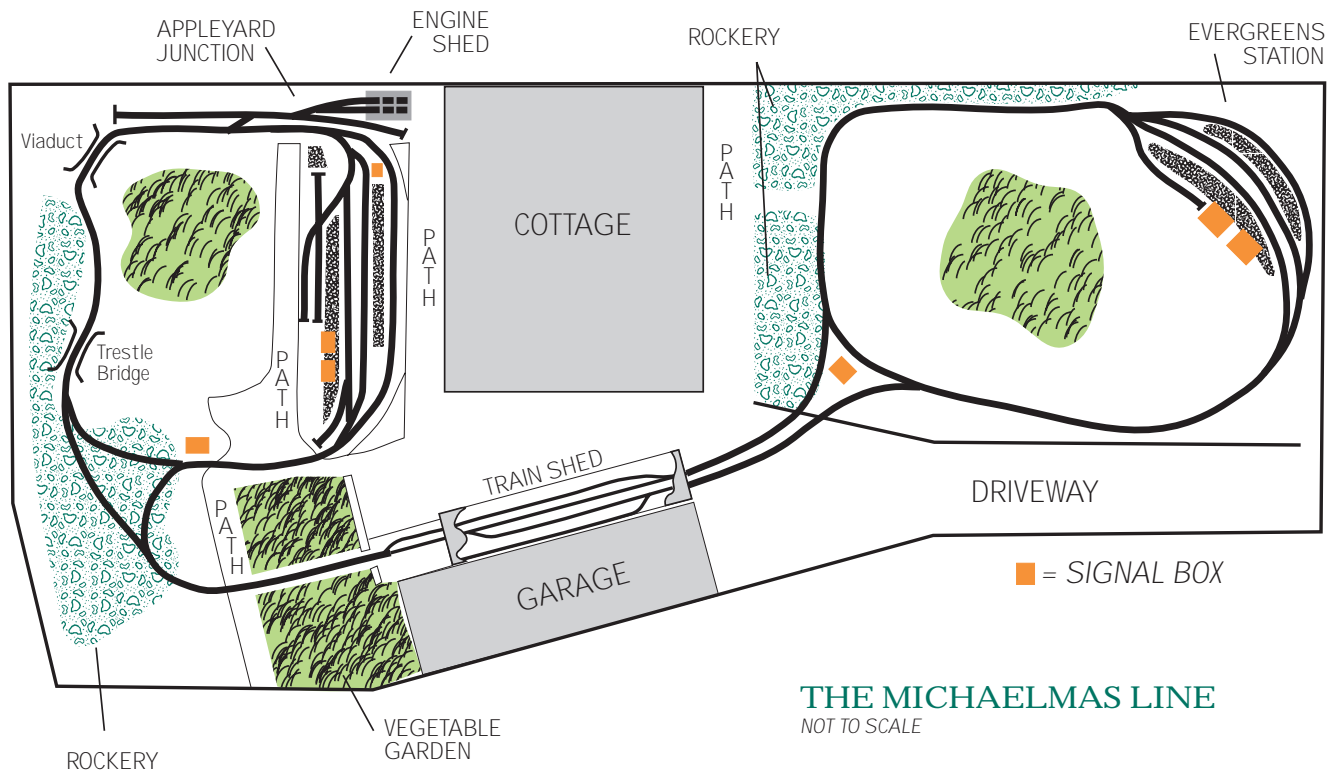

Everything in the LGB range is exquisitely molded in plastic and I am very fond of modeling in this material. You have the best of both worlds—you can get a railway running quickly, you can buy ready-to-run models or make highly individual models quickly. I know not everyone shares my enthusiasm for plastic, but its use is growing and its complete acceptance is only a matter of time. It is clean, supple, strong, easy to cut and weld together and takes paint well. It can also be laminated if necessary, and warping will not occur if the right thickness of material is used and a little care exercised.

The Michaelmas Line is Born

The Michaelmas Line started as a 35-yard oval in the back garden, with a passing loop and Appleyard Station situated beside the rear of the cottage. As the line was raised up some 12 inches at this point, it was very convenient for placing rolling stock on the track and lighting up the Gauge 1 live steamers. However, within eighteen months and the change to LGB, an extension was started that took the line away from the circle on the left hand side via a triangle junction and a long curve down the side of the house.

At this point, a train shed was built for rolling stock storage. I consider this very important, as storing rolling stock on the line is the best method, and saves considerably on the damage factor due to excessive handling. The present train shed was built only four years ago to replace the original one, which had become too small. It has four storage roads some twelve feet long and a series of shelves directly above. Handling is therefore cut to a minimum.

From the train shed, the line continues down the side of the cottage, across the path leading to the house and around the sides of the front lawn, which is much larger than the rear garden. Two sides are bordered by a rockery and the line runs along the junction between this and the lawn until it reaches three passing loops forming Evergreens Station.



The line then continues on down the other two sides of the lawn, before reaching the triangular junction to the back garden and train storage shed. The abundance of foliage separating the front of the lawn from the pavement outside makes the line quite inconspicuous, even to anyone walking up the front drive—that is, until the train passes by!

When it comes to building a garden railway, I have always preferred to lay the line at ground level or on a rockery. I cannot accept a line on wooden poles. This to me is not a garden railway, but a layout outdoors. For me, a garden railway means a line that is fully integrated with the garden and in no way detracts from the overall view.



The Michaelmas Line is built at ground level or on earth embankments covered in grass or ground cover plants. In this way, it blends in well with the rest of the garden. The track is laid in a trough about 1.5 inches deep and about 5.5 inches wide for single track. To the sides I have fixed aluminum strips to form the trough. This is then filled with limestone chippings about 6 mm in size and the track laid on top and fixed with a brass two-inch screw every 18 inches—closer on curves. Where the track is laid beside the lawn, the lawn mower can come right up to the edge and the front wheel can even run over the track. In this way the garden is easily maintained.

An R.R. Class 7 pilots an S.A.R. J Class through the front garden (above). Steam and diesel come together at Appleyard Junction (below).

3-D Modeling

Story by Annie and Joe Mellen

Photos and Graphics by Marc and Barb Horovitz

It's not surprising to find a garden railway that represents Colorado narrow-gauge operations. What is unusual, we think, is a line that has substantial changes in elevation, with many raised areas approximately waist high. We call this idea a three-dimensional plan, as opposed to a railway that's mostly on the ground at grade level. This 3-D effect was achieved by using an extended folded-dogbone track plan, with one of the loops at grade level and the other raised three to four feet.

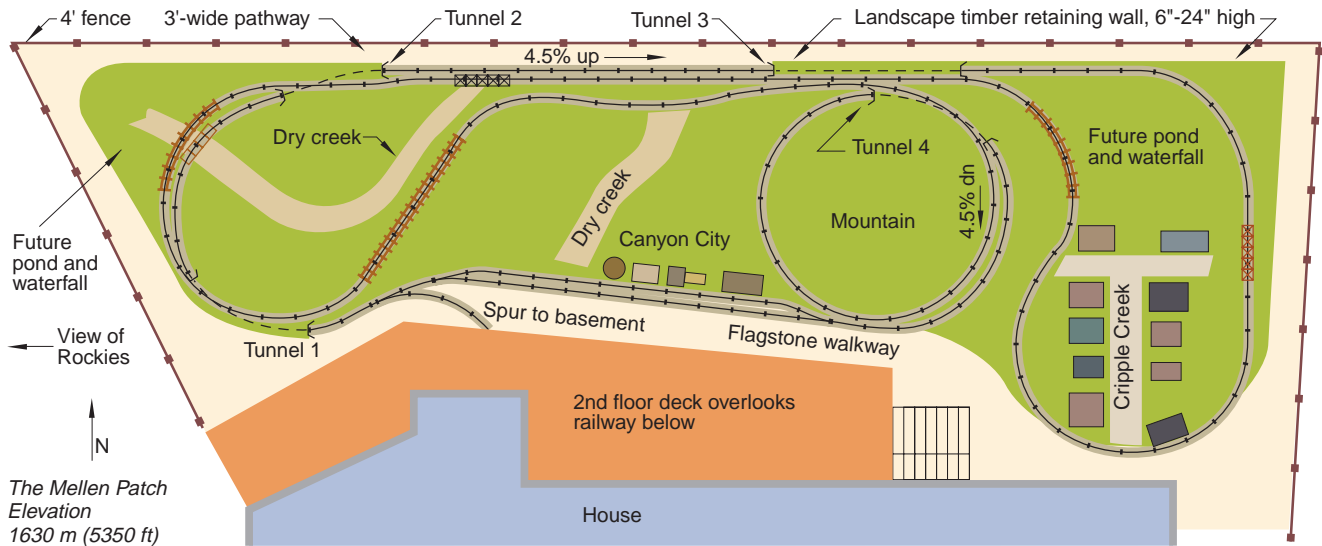

Our trip along the line starts at the Canyon City Station. As we leave the station we see the sand house, coaling tower and water tower in the yard. These structures are placed on our line in the same order that they appear on the Cumbres & Toltec at Chama, New Mexico.

We soon reach the entrance to Tunnel 1, which takes us into a fertile valley surrounded by high mountains covered with ivy. This area is sparsely populated, with only a farmhouse, barn and two bridges. It's easy to see the scenery, which is composed primarily of thymes, sedums and miniature trees.

After we pass over a bridge and stream and through Tunnel 2, we start up a long 4.5% grade that runs for about 20 meters (67 ft) along the back of the yard. Climbing this hill is a struggle, but we eventually reach the summit and cross a Howe through-truss bridge.

Cripple Creek is next. A collection of buildings, mostly made from kits, defines the small town that the train encircles. Leaving the town behind, we cross a tall, curved trestle before starting up another grade. At the top of the rise, the train crosses a high steel bridge that takes us back around the farm area, this time high above the lush valley.

Multiple track levels make the Mellen layout more interesting than flat layouts.



Leaving the farm behind, we traverse a 3.7 meter long, 1.2 meter high (12.0 ft long, 4.0 ft high) trestle, after which we begin heading down and around the mountain. The train circles the mountain twice as it descends to ground level. As we round the last turn, Canyon City Station comes back into view, and we've completed our 3D journey.

LGB Photo Gallery

It would take an entire library to show you all the great sights in the World of LGB. Here are just a few...



The big Grund layout, located near Nürnberg, is a popular stop for LGB tours.



Wolfgang Richter's children test the very first working LGB loco on one of the very first LGB layouts.

The famous "Elephant Test" photo was used in early LGB advertising to demonstrate the strength of LGB track.



LGB Depesche was the first magazine for LGB fans. For English-speaking fans, there's LGB Telegram magazine.



The Mignone layout captures the colorful detail of an industrial loading dock.



The Salazar layout recreates classic Swiss railroading in the forests of New England.



The headlights of a LGB F7 diesel split the night on the Chaplin layout.

Yes, you can run your LGB trains in the snow.



The best garden railways offer more than just trains. The Coutinho's have integrated their layout into a large garden. The layout controls are in the gazebo.



The Broz layout appears to be building itself!



There's a layout within a layout on the Raditz layout.



LGB Q&A

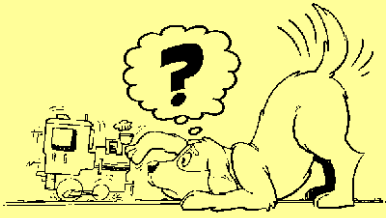

What plants should I use in my garden railway?

Barbara Abler, garden consultant to LGB Telegram magazine, on the garden in your garden railway...

Many LGB owners are hesitant to move their beautiful trains outdoors into the garden. Often the reluctance seems to stem from feelings of inadequacy in dealing with plants by those who have little experience with landscaping or gardening other than growing grass or vegetables. Yet it is outdoors that you can come the closest to emulating the operation of the real railroads. You have to deal with weather, terrain, and even animals just as the prototypes do and the scenery on your outdoor railroad changes every day.

The first thing to remember is that a garden railroad is a type of fantasy, and it's your fantasy. So, the landscape can be whatever you choose it to be. If all you want to do is run trains outdoors and don't want to maintain a miniature landscape, that's fine. I have seen some lovely layouts in which track was put down in existing gardens. The owners run trains between perennials, annuals and sometimes even vegetables. They are having fun and that is what counts.

If you want to create a miniature landscape to complement the trains, then you need to learn what plants will do well in your geographical area. There are many ways to learn about plants.

A good general reference book is very helpful. Ideally, it should cover a large variety of plants, have a lot of pictures, and contain general cultural information. Plant and seed catalogs can also provide a great deal of information less expensively. When reading catalogs, remember that the descriptions are often written to entice you to buy and they may be a bit over-enthusiastic.

You can learn a lot about plants by visiting public gardens, parks and arboretums. Those that have an educational mission will have plants labeled or identified in some way. Many horticultural societies and garden clubs provide tours of private gardens that are great educational opportunities. Visits to local garden centers and nurseries give you the opportunity to see what plants are available in your area and you can seek out knowledgeable staff for more information. Finally, friends who are gardeners or members of garden railroad clubs are a wealth of practical information. Most gardeners I know are more than happy to share their knowledge.

When choosing plants for the railroad, pick those that are suitable for your climate. Don't try to grow alpine plants if you live in a tropical climate. Also, it would be counter-productive to try to model a desert landscape in an area with very high annual rainfall. If I'm not sure how a plant will do, I experiment. My rule of thumb is: If it is cheaper than a pizza, I'll try it. Even if it lasts only a week, that's longer than the pizza lasts and there are no calories or fat.

It is impossible to get Nature to provide plants that are in true scale with your trains. The best you can hope to do is find plants that give the impression of being in scale. There are a lot of dwarf conifers available that can be used to mimic full sized conifers. A pair of pruning shears and



Woolly Thyme forms a dense lawn in the Babka railroad (top).

Duckfoot Ivy makes a nice shrubby background (middle).

Sweet Alyssum on the left and Swan River Daisy on the right crowds the trackside waiting for the Porter to pass (bottom).

another ground cover, has a wonderful texture and color and is slower growing than other ajugas, making it ideal for a shady spot in the railroad.

Various small dianthus or pinks are great mimics of taller grasses or small shrubs. They have the added advantage of having delightful flowers. There are many rock plants that are small in scale and are excellent additions when given proper drainage. Choose plants that have finely-divided foliage and whose height is appropriate for the type of planting they are to mimic. Remember, an adult thumb is about 1.5 G-scale meters (5 G-scale feet) high. So a plant that is about one thumb tall will be a suitable impersonator for a 1.5-meter (5 foot) shrub.

garden scissors are recommended tools. The congested Dwarf Alberta spruce (*Picea glauca* 'Conica') can be pruned severely to make it look more like a natural spruce or pine. Many shrubs can be pruned to help them mimic full scale trees. Smaller spireas, cotoneasters, potentilla and boxwoods lend themselves to severe pruning. The herb rosemary can be pruned to look like a shrub or tree and its needle-like foliage mimics that of conifers. There are several dwarf elms that might be too large if allowed to grow freely but can be pruned to be kept in scale. Try to do the major part of the pruning before putting the plant in the ground. It is much easier that way!

Plants used as ground cover should not be invasive. *Mazus reptans* and *Lysimachia nummularia* are frequently recommended as ground covers. But these plants spread rapidly and can soon become thugs in the garden, swallowing up track, switches and other plants. Avoid anything labeled as a vigorous spreader. The smaller, mat-forming thymes make attractive lawns and pastures. They grow relatively slowly but will eventually spread into the track. However, they are easy to control and the clippings can be used in cooking. Irish moss (*Sagina subulata*) is an excellent mimic of grass. It will intermingle with other ground covers to provide an interesting mixed lawn. Spinach ajuga (*Ajuga metallic crispa*),

Tight columns of a dwarf juniper (*Juniperus communis* 'Compressa') flank a dwarf cypress (*Chamaecyparis pisifera squarosa* 'Intermedia') below the track on the Hill layout (right).



Rock Cress (*Arabis ferdinandicoburgii* 'Variegata') forms a low, evergreen mat that provides a nice color variation (above).

Erodium reichardii is a real charmer and provides summer-long color (below right).



You will want a large percentage of perennials in the landscape to minimize the amount of planting you have to do every year. But perennials generally bloom for only a short period of time. Strategic placement of annuals will give longer lasting color and added interest. Plants with fine foliage and small flowers, such as lobelia and alyssum, work very well.

A variety of colors, textures, sizes and shapes will provide the most

pleasing and natural of landscapes. Create compositions in the landscape that combine a spiky plant with one that is rounded and one that is flat. Pair foliage with a blue color, such as blue fescue grass (*Festuca glauca*), with a plant with yellow-green foliage, such as Rheingold arborvitae (*Thuja occidentalis* 'Rheingold'). Add a small dark green spruce such as *Picea abies* 'Little Gem' and you have a combination of shapes, textures and colors that is attractive. Place some large plants in such a position in relation to the track so that they will block your field of vision and the train will seem to disappear. Try combinations of plants while they are still in their pots to get an idea of how they will look together. With practice, your eye will tell you what works just as it does when you evaluate a track plan or a train consist.

Finally, don't get hung up on the pronunciation of the formal Latin taxonomic names of plants. Pronunciation may vary, just as with trains. (I have heard Mallet pronounced three different ways.) And if you can pronounce Uintah, you can handle many of the formal names as well. These names help to ensure that you get the plant you really want.

Whatever type of landscape you choose, the plants in the garden will enhance the setting for your trains and increase your enjoyment of this wonderful hobby.

A Few Favorite Garden Railway Plants

Name	Characteristics	Height (approx.)
<i>Ajuga reptans</i> <i>metallica crispata</i> (Spinach Ajuga)	Perennial. Sun or shade. Mat-former.	50 mm (2 in)
<i>Arabis ferdinandi-coburgi</i>	Perennial. Sun. Mat-former.	20 mm (1 in)
<i>Bellium minus</i> (Miniature English Daisy)	Annual, short-lived perennial. Reseeds. Mat-former. Sun.	0.5-2in (1-5cm)
<i>Brachycome iberidifolia</i> (Swan River Daisy)	Annual. Sun.	200-300 mm (8-12 in)
<i>Chamaecyparis obtusa</i> 'Hage' (Dwarf Hinoki Cypress)	Evergreen conifer. Sun.	200 mm (8 in)
<i>Chamaecyparis pisifera squarosa</i> 'Intermedia' ..	Evergreen conifer. Sun.	200 mm (8 in)
<i>Chamaecyparis pisifera</i> 'White Pygmy'	Evergreen conifer. Sun.	200 mm (8 in)
<i>Cotoneaster dammeri</i> 'Streib's Findling'	Shrub. Sun.	200 mm (8 in)
<i>Dianthus gratianopolitanus</i> 'Tiny Rubies'	Perennial. Mat-former. Sun. Foliage	50-75 mm (2-3 in)
<i>Erodium reichardii</i>	Perennial. Sun.	50-75 mm (2-3 in)
<i>Festuca glauca</i> (Blue fescue)	Perennial grass. Sun.	300 mm (12 in)
<i>Hedera helix</i> 'Duckfoot' (English Ivy)	Evergreen vine. Part shade or shade.	460 mm (18in)
<i>Hosta venusta</i>	Perennial. Shade or part shade.	50-75 mm (2-3 in)
<i>Juniperus communis</i> 'Compressa'	Evergreen conifer. Sun.	600 mm (24 in)
<i>Juniperus communis</i> 'Pencil Point'	Evergreen conifer. Sun.	1.5-1.8 m (5-6ft)
<i>Lobelia erinus</i> 'Crystal Palace'	Annual. Sun or part shade.	100-150mm (4-6 in)
<i>Lobularia maritima</i> (Sweet Alyssum)	Annual. Sun or part shade.	50-100mm (2-4in)
<i>Picea glauca</i> 'Conica' (Dwarf Alberta Spruce) ...	Evergreen conifer. Sun.	1.8 m (6 ft)
<i>Rosa</i>	numerous miniature and micro-mini rose cultivars, e.g. Cinderella and Red Minemo. Perennial. Sun.	300-600 mm (1-2 ft)
<i>Rosmarinus officinalis</i> 'ARP' (Rosemary)	Tender perennial shrub. Sun.	0.3-1.5 m (1-5 ft)
<i>Sagina subulata</i> (Irish Moss)	Perennial. Mat-former. Sun or part shade. ...	25 mm (1 in)
<i>Spirea japonica</i> 'Little Princess'	Shrub. Sun.	400-500 mm (16-20 in)
<i>Thuja occidentalis</i> 'Rheingold' (Rheingold Arborvitae)	Evergreen conifer. Sun.	0.9-1.8 m (3-6 ft)
<i>Thymus pseudolanuginosus</i> (Woolly Thyme) ...	Perennial herb. Sun.	20-50 mm (1-2 in)
<i>Thymus serpyllum</i> 'Elfin' (Dwarf Thyme)	Perennial herb. Sun.	20-50 mm (1-2 in)
<i>Thymus serpyllum</i> 'Minus' (Dwarf Thyme)	Perennial herb. Sun.	20-50 mm (1-2 in)

The small dianthus, 'Tiny Rubies,' provides a short, shrubby groundcover during most of the year along colorful, pom-pom flowers in the spring.





CHAPTER 15: STAYING ON SCHEDULE

With just a few minutes of care, your LGB trains will give you many years of fun.



When Gustav inspects the tracks on his handcar, he always carries all the tools he needs, including a big barrel of lubricating oil. Gustav says, "If you oil well, you run well."

Of course, there are rumors that Gustav's barrel holds beer, not oil, and seriously, you don't need a lot of oil to make your LGB trains run well.

You only need a little bit of lubrication, a few tools and some simple instructions to keep your LGB trains running efficiently for years and years.

Your LGB Toolbox

For the most common service and maintenance tasks, you only need a few tools:

- **50010 Smoke and Cleaning Fluid.** This clear fluid is usually used in LGB smoke generators. It can also be used to clean LGB products, including track rails, locomotive wheels and body parts. It can be used on LGB plastics and evaporates quickly.

- **50019 Maintenance Oil.** This general lubricant is packaged in a pen-style container with a precision needle dispenser.

- **50020 Special Tool Set.** This set includes a straight screwdriver, a Phillips screwdriver, a 3 mm socket driver and a 6 mm socket driver. These tools fit most of the screws and bolts found on LGB products. The set also includes a wire stripper.

- **50040 Track Cleaning Block.** This hand-held tool cleans your track with a non-abrasive, synthetic pad.

- **51010 Conductive Paste.** For outdoor layout builders, this graphite lubricant is essential. Just put a small amount, the size of a pea, in each rail joiner to keep out water, resist corrosion and improve conductivity. (Be careful using 51010 indoors, it will stain.)

- **Pliers.** Needle-nose pliers are useful for a variety of tasks, like replacing light bulbs and smoke generators.

- **Wire cutting/crimping tool.** A quality wire cutting and connector crimping tool will make complex wiring tasks much more pleasant.

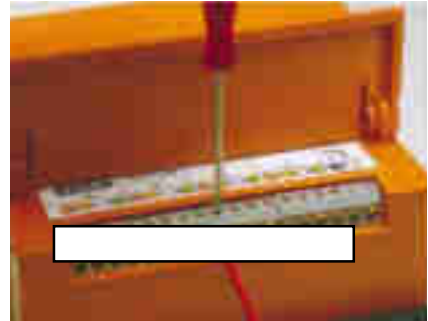

Making it Stick

The same chemical characteristics that make LGB plastics rugged and weather-resistant also make them extremely difficult to join with adhesives. In fact, the craftsmen at Ernst Paul Lehmann Patentwerk rarely use adhesives to assemble LGB products. Instead, they use mechanical fasteners and ultrasonic welding.

If you break a plastic part on an LGB product, your best choice is to replace the part. Parts are available for repairs from the LGB service stations in Nürnberg and San Diego (see Page 210).

If replacing the part is not practical, you can attempt to glue the parts together with a solvent called "MEK" (methyl ethyl ketone) which is available at many hardware stores.

Attention! MEK is a powerful solvent. Use it properly in a well-ventilated area.



Maintenance Tips

LGB products usually require very little maintenance. Just follow these simple instructions for most LGB products:

Attention! Improper service may void your warranty. For factory authorized service, contact an authorized retailer or send your LGB product to an LGB service station (see Page 210).

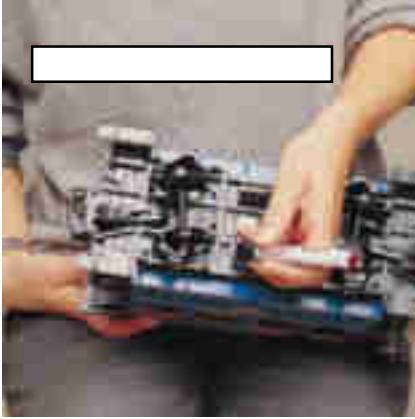

A little oil is usually better than a lot of oil.

Lubrication

The axle bearings and drive rod ends of LGB locomotives should be lubricated occasionally with a small amount of 50019 Maintenance Oil. An excessive amount of oil can enter the gearbox and dissolve the heavier lubricant inside the gearbox.

The axle bearings of LGB freight and passenger cars should be lubricated occasionally with a small amount of 50019 Maintenance Oil.

Hint: A little oil is usually better than a lot. Excess oil attracts dirt and other pollutants.

Cleaning

Most LGB models can be cleaned using a mild detergent and gentle stream of water. However, do not immerse LGB models in water, and if the model is equipped with sound electronics, do not expose the electronics or speaker directly to water.

Hint: Many LGB experts clean their trains with 50010 Smoke and Cleaning Fluid. Fill a small dish with the fluid, and dip a soft brush into the fluid. Then clean your trains with the wet brush.

EPL Switches and Signals

EPL switches and signals require some special maintenance, particularly when used outdoors:

- Do not lubricate EPL switch or signal drives.
- For reliable operation, switches should be kept free of dirt and debris.

The critical points (circled in red) can be lubricated occasionally with a small amount of 50019 Maintenance Oil.

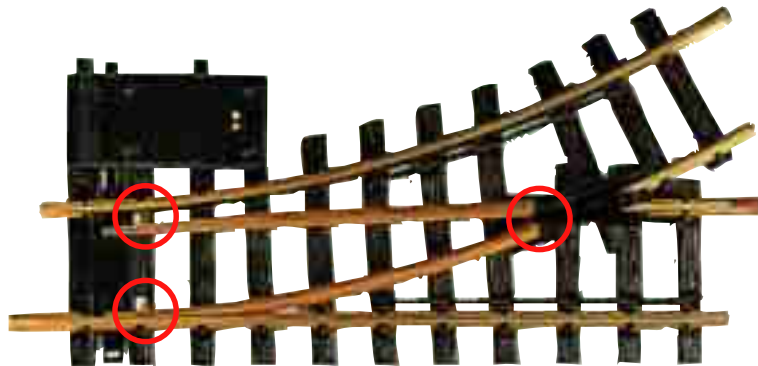

- EPL switch drives can be disassembled—carefully—for cleaning by removing the four screws that hold the cover to the base. After cleaning, reassemble the drive carefully. The throw rod (1) is correctly positioned when the tab on the pinion gear (4) is pointing straight up and the throw rod is in the center of its travel. Test the drive before installation.

EPL switch drives can be disassembled...carefully!

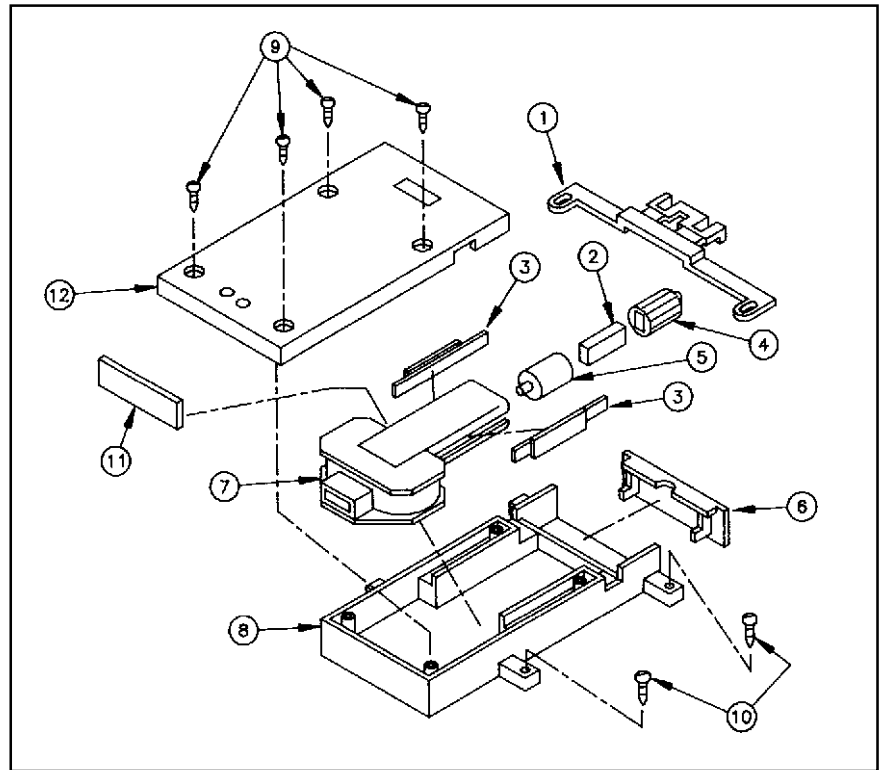

- The arm mechanisms on EPL signals should be lubricated occasionally with a small amount of 50019 Maintenance Oil.
- In wet weather, EPL drives should be protected from flooding. Mount the drives so that water drains away from them, instead of ponding around them.
- In winter, EPL switch drives outdoors should be covered. Older three-wire switch drives should be removed.
- In winter, EPL signal masts outdoors should be removed.

Storage

The best way to store LGB products is in their original packages. These packages are ruggedly designed for long-term storage.

Hint: Many LGB locomotives include custom-molded inserts to hold the loco in place. When you unpack the loco, mark the inserts with a permanent marker so you can return the inserts to their original positions.

Track Cleaning



**Stronger
than
Dirt**

Dirty track is the most frequent cause of poor train operation, especially on outdoor layouts. The ultimate solution to the track cleaning problem is the 20670 Track Cleaning Loco. It automatically cleans the rails without damaging them. Just put it on the track, start it up and watch it work. (For more information, see "Stronger Than Dirt" below.)

If you want a bit more exercise, use the hand-held 50040 Track Cleaning Block (above left).

For regular maintenance, use the 50050 Track Cleaning Attachment (below left). It will not remove a heavy accumulation of grime, but it will help keep clean track clean. It fits on the bottom of many LGB two-axle cars, like the "4040" series tank cars.

All of the LGB track cleaning tools use synthetic cleaning materials that "erase" dirt without damaging the rails. Do not use strong abrasives, like sandpaper or emery cloth, to clean the track. They will grind away the rails and leave scratches that attract more dirt. Also, do not use steel wool. The metal fibers can damage your trains.

Hint: The cleaning pads used on the 20670, 50040 and 50050 can be saturated with 50010 Smoke and Cleaning Fluid for easier and more effective cleaning.

Heinz Koopmann, chief technical consultant to E.P. Lehmann Patentwerk, offers tips on using the 20670 Track Cleaning Loco...

The 20670 is commercial machine in the truest sense of the word. And like a commercial machine, it requires a bit of knowledge to operate properly. That knowledge can be found in the instruction manual, but for those of us who play first and read later, here are some tips...



The soft cleaning wheels of the 20670 contain particles that clean the rail head. The faster the particles move across the rail head, the better they clean. So, if the cleaning wheels rotate quickly in relation to the rail head, the particles will travel faster and clean better. To make this happen, the cleaning wheels must turn quickly while the locomotive moves slowly.

How can you apply this theoretical knowledge? Follow this procedure...

1. If the rails are extremely dirty, hand-clean a small section of track about 300 mm (1 ft) long. The 50040 Track Cleaning Block is perfect for this. Since the 20670 requires current from the rails to operate, you need some clean rails to start the loco and the cleaning process.



After your feline assistant checks the layout for mice, check it yourself for animal damage.

2. Set the slide switch in the engineer's cab for track cleaning.
3. Lift off the round plastic cap on the roof of the cab, and turn the locomotive speed control to its minimum setting.
4. Turn your speed control to full power. By providing full power, the cleaning wheels will turn at maximum speed. However, the loco will move very slowly, since the loco speed control is at the minimum setting. As described earlier, this will provide the maximum cleaning wheel speed relative to the rail head, and therefore, it will provide the maximum cleaning effect.
5. If the 20670 stalls on grades or curves, adjust the locomotive speed control, but only in very small increments. Eventually, you will find the optimal speed for your layout.

Normally, this simple procedure will clean the most oxidized tracks so well that your LGB trains will run easily. However, my experience shows that when the track is very dirty it is advisable to clean your tracks twice--once in each direction. This reduces the effect of mountain and valley grades on the cleaning process.

Now, I have two words for the LGB fans who are concerned that the 20670 will damage their rails: "Don't worry!"

Remember, you must have clean track for your trains to operate properly. If you use a handheld cleaning device, the abrasive speed is slow, and the pressure is inconsistent. The fixed abrasive grinds dirt into the rail, and large amounts of brass may be lost. On the other hand, the 20670 works efficiently at high speed and consistent pressure. Dirt is thrown away from the track, and only a tiny amount of brass is removed.

All in all, I can say this: I am a daily track cleaner. Often, during the development of the 20670, I cleaned my track repeatedly each day, and after many years, my rails are still fine!

More Track Cleaning Loco Tips

- If you want to increase the traction of your locomotive on steep grades, you can use the 20670 to roughen the rails. First, clean the grade normally with the 20670. Then put the 20670 at the beginning of the rise, and turn your LGB speed control to a middle position, not full speed. The cleaning wheels will revolve slowly and roughen the rails. This has some of the same negative effects as hand cleaning, so only use this procedure in special cases.

- To achieve a flawless cleaning effect, you need a power supply that delivers at least 2 amps. You can use the "5006/5007" combination or, better still, the Jumbo power pack.

- The cleaning wheels have a very long life. They should be replaced **before** the gray abrasive material is worn down to the flange discs. Excessively worn wheels can damage plastic parts on some track sections. Replacement cleaning wheels are available as LGB part number 67267.

- During track cleaning, you should closely monitor the progress of the 20670. If the loco is blocked during operation, say, because your cat has toppled a telephone mast onto the track, the cleaning wheels will keep turning and make an unsightly mark in the rails.

Happy track cleaning!

Sample Service Procedures

If your LGB product requires service, you should send it to an LGB service station for factory authorized service (see Page 210). However, if you are mechanically inclined, you may want to perform some simple repairs yourself.

Some specific service procedures can be found in the instructions for individual LGB products. The sample procedures here are for a typical LGB locomotive. The specific procedures vary from model to model:

Attention! Improper service may void your warranty. For factory authorized service, contact an authorized retailer or send your LGB product to an LGB service station (see Page 210).

Replacing the Light Bulbs

- Front and rear lanterns: Remove the ring around the lantern lens. Carefully pry the lens away from the lantern. Pull the plug-in bulb out of the socket. Plug a new bulb into the socket. Reassemble.
- Cab light: Pull the plug-in bulb out of the socket. Plug a new bulb into the socket.

Replacing the Smoke Generator

Pull the safety ring out of the smoke stack (Fig. 1). Use pliers or tweezers to pull the old smoke generator out of the stack (Fig. 2). Cut the wires to the old generator and attach them to the replacement generator (Fig. 3). Insulate the connections and push the replacement generator into the stack. Reassemble.

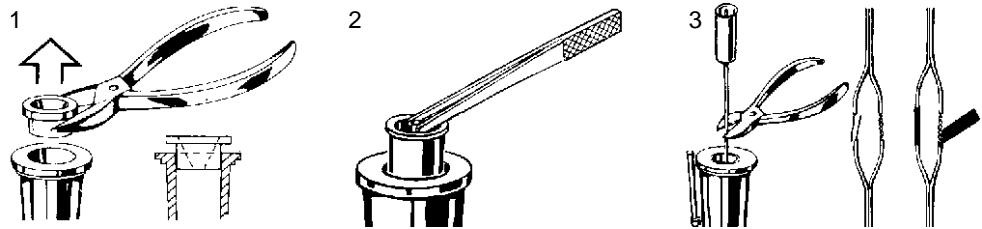

Replacing the Traction Tire

- Use a small, straight-blade screwdriver to gently pry the old traction tire out of the wheel groove.
- Gently warm the new traction tire in a dish of warm water.
- Use a small, straight-blade screwdriver to gently pry the new traction tire into the wheel groove.
- Make sure that the traction tire is completely seated in the wheel groove.

Replacing the Motor

The gearbox must be removed to replace the motor:

- Remove the hex head screws joining the drive rods and connecting rods at the rear wheels.
- There are three screws on the bottom of the gearbox. Remove the front and rear screws. Do not remove the center screw.
- Pull the gearbox away from the chassis. The top plate of the gearbox will remain attached to the chassis.

Attention! Make sure that the motor and other parts do not fall out of the gearbox.

- Replace the motor. Reassemble.

Attention! If the motor is replaced, generously lubricate the gears with 51020 Gear Lubricant.

Attention! If the motor is replaced, make sure that the drive rods do not bind. Binding can cause serious damage to the model.

Replacing the Brushes and Wheelsets

Remove the three screws on the bottom of the gearbox. Remove the bottom of the gearbox. Note the position of the power strips. If necessary, replace the brushes or wheelsets. Reassemble.

Attention! If the wheelsets are replaced, generously lubricate the gears with 51020 Gear Lubricant.

Attention! If the wheelsets are replaced, make sure that the drive rods do not bind. Binding can cause serious damage to the model.

No Drunken Locos

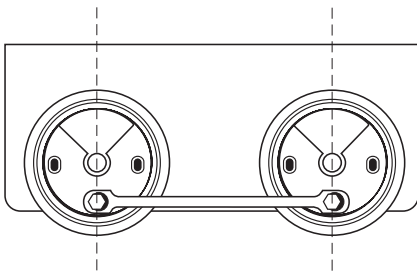

You put a new motor in your LGB locomotive and now it lopes down the track like it's drunk. What happened?

The drive wheels are probably out of alignment or "out of quarter." Most LGB steam locos (and some other LGB locos) have side rods that connect the drive wheels. If the wheels aren't properly aligned, those connecting rods will bind as the wheels rotate.

When you replaced the motor, you probably knocked the wheels out of alignment. Here's the proper "quartering" procedure to prevent that problem:

- Before you put the motor in the gearbox, rotate the drive wheels on one side so the mounting posts for the rod are pointed straight down. Lines drawn from the mounting posts through the axle centers should be at a 90° angle to the ground.
- Drop the motor into position, making sure the worm gear on the motor shaft meshes with the drive gear. Do not allow the wheels to rotate.
- Reattach the gearbox cover, locking the motor into position. Again, do not allow the wheels to rotate.
- Now, rotate the wheels by hand in 90° increments. Each time you stop, wiggle the connecting rods. The rods should move freely at every stop.
- Reinstall the gearbox in the loco.

You should follow this procedure whenever you replace the motor and whenever you move the motor to replace some other component, like the wheelsets.

Also, the drive wheels can be forced out of quarter if the loco is unusually stressed, for example, if it is heavily overloaded. Follow this procedure to requarter the drive wheels.

The Secret Inside

LGB trains are engineered for simple operation, but they're not simple inside. A typical LGB locomotive has more than 100 component parts, including structural sections, wheels, gears, rods, motors, detail items, printed circuit boards, wiring harnesses, bulbs and much more.

For example, here is a parts diagram of a 21881 "Mallet" locomotive. It has more than 170 different parts, not counting multiples of identical parts. The sound version of the same loco has dozens of additional parts, including a speaker, cables, sensors, switches and circuit boards.

Hint: These diagrams are from *LGB Service*, a ring-bound reference guide with diagrams and parts listings for LGB products. *LGB Service* includes a starter edition (00290) and annual supplements with new LGB products. For more information, see the current LGB catalog.

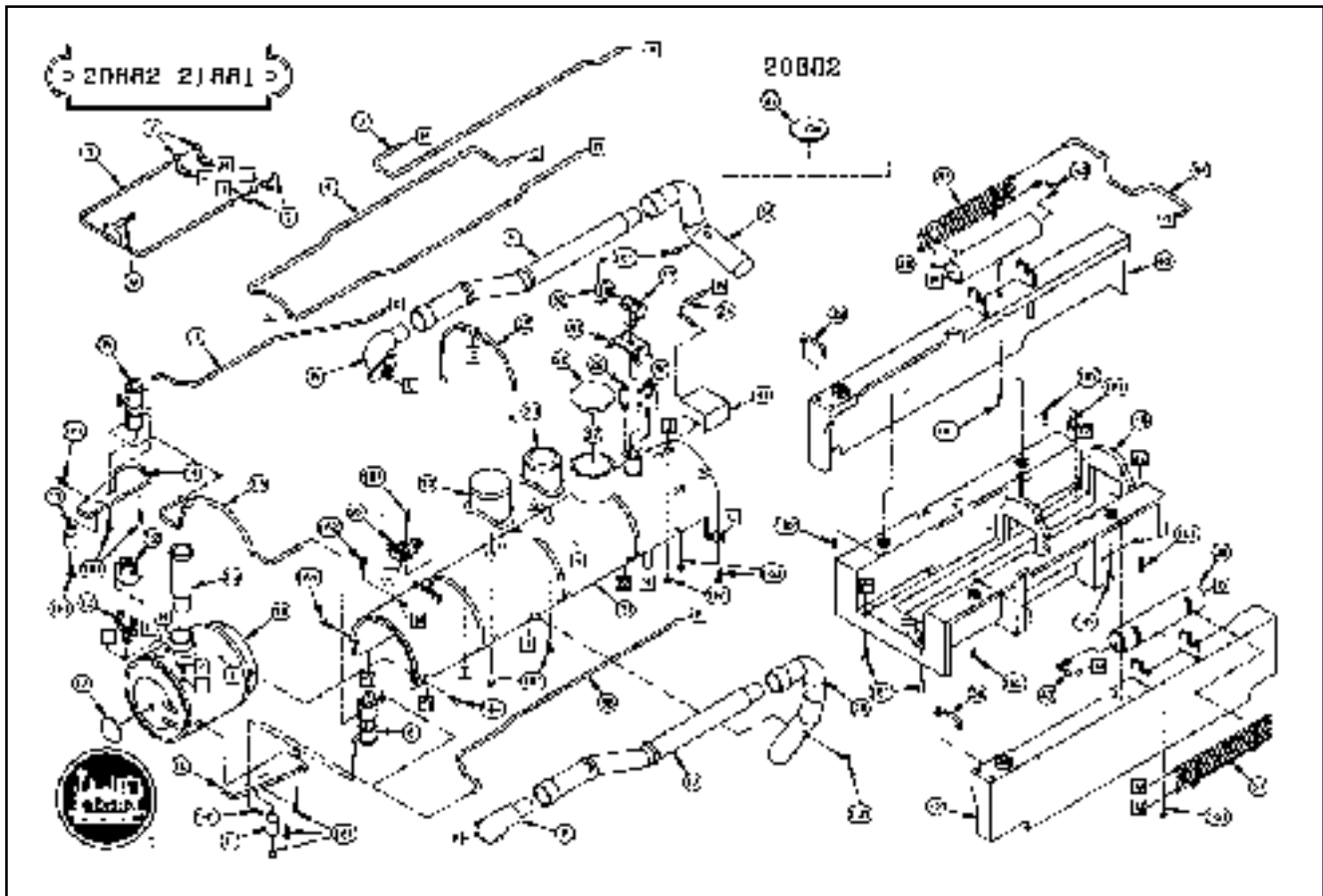

LGB Q&A

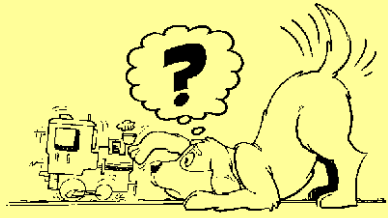

LGB service stations, at Ernst Paul Lehmann Patentwerk and LGB of America, have skilled technicians ready to repair your trains.

What should I do if my LGB train needs repairs?

For all but the most basic repairs, let the factory fix it. LGB service stations are staffed by very experienced professionals with a vast inventory of the latest repair parts. The service stations—located in Nürnberg, Germany and San Diego, California—provide fast and fair service to thousands of LGB owners every year.

For more information on factory authorized service, contact an authorized retailer or send your train directly to one of the LGB service stations:

Ernst Paul Lehmann Patentwerk
Saganer Strasse 1-5
D-90475 Nürnberg
GERMANY
Telephone: +911 83707 0
Fax: +911 83707 70

LGB of America
6444 Nancy Ridge Drive
San Diego, CA 92121
USA
Telephone: +619-535-9387
Fax: +619-535-1091



You are responsible for any shipping costs, insurance and customs fees. **Hint:** Pack your trains carefully for shipping using the original box, with all its inserts, placed in a larger shipping carton with plenty of packing material. Poorly packed products often suffer extensive damage during shipping.

Be sure to include your complete name, address and telephone number, along with a description of the problem, proof of purchase and any other information that may be helpful in diagnosing the problem.



LGB Q&A

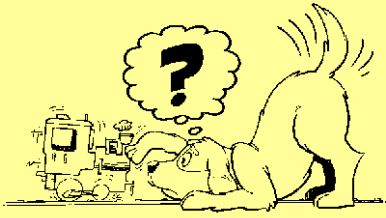

Where can I learn more about LGB?

One of the best sources for information about LGB is the big LGB catalog. Generally, Ernst Paul Lehmann Patentwerk publishes a LGB catalog each year, and the catalog is generally available from authorized LGB retailers.

Also, there are two official LGB magazines packed with news about new LGB products, great LGB layouts and fascinating LGB people. The official English-language magazine is *LGB Telegram*. For subscription information, contact:

LGB Telegram
PO Box 332
Hershey, PA 17036
USA
www.lgbtelegram.com

The official German-language magazine is *LGB Depesche*. For subscription information, contact:

LGB Depesche
Ernst Paul Lehmann Patentwerk
Saganerstrasse 1-5
D-90475 Nürnberg
GERMANY
www.lgbdepesche.de



Look for the LGB news in *LGB Telegram*, *LGB Depesche* and the LGB catalog.

There are also a large number of LGB-related clubs around the world. Information on those organizations can often be found in *LGB Telegram* and *LGB Depesche*.

Safety Tips for Smart Explorers



You are the most important part of the safety equation. So observe the safety instructions included with your trains.

LGB trains are made to be beautiful. LGB trains are made to be fun. But most of all, LGB trains are made to be safe.

LGB products are engineered to meet or exceed international standards for safety. For example, LGB products have earned the GS (Geprüfte Sicherheit), UL (Underwriters Laboratories), Sehr Gut (Stiftung Warentest) and CE (European Community) seals of approval.

Also, Ernst Paul Lehmann Patentwerk has worked directly with safety authorities to develop innovative LGB products, like the 10 amp Jumbo power pack, that offer you advanced features while still meeting strict safety standards.

However, the product is only one part of the safety equation. You are the most important part. Here are some important tips:

- Any device connected directly to house current must be kept indoors or in a weather-protected enclosure. For outdoor layouts, install the power supply indoors and connect it to an LGB control outdoors. The LGB program includes a variety of speed and accessory controls designed for outdoor use.

- Inspect power supplies regularly for possible dangers. Look for damage to the cables, plugs or housing. If damage is found, do not use the power supply.

- Disconnect power supplies from house current if there is a short circuit or overload. Remove the short circuit or overload before connecting the power supply again.

- Do not connect the AC output terminals of two or more power supplies in parallel. This can create an electric shock hazard.

This can happen inadvertently by using two Multi-Train System Central Stations on the same layout. Even if the layout is divided into electrically isolated sections, that isolation may be lost when a locomotive crosses the gap between the sections.

- Do not connect the Multi-Train System and a conventional power system to the same layout. For example, do not use a powered catenary system together with the Multi-Train System on the same layout. A short circuit between the track and the catenary could produce a dangerous high voltage.

- Many LGB products have small parts, sharp parts and moving parts. Locomotive driving rods can pinch and bind.

- Observe all safety instructions. Save the instructions and packaging supplied with LGB products. Read the instructions carefully for safety information for individual products.

- Improper service may void your warranty. For factory authorized service, contact an authorized retailer or send this LGB product to an LGB service station.



Thanks!

This book was not written by one person in one place at one time. This book represents the combined efforts of dozens of people from all over the world over many years. It began with the late Robert Münzing, who wrote the very first LGB technical guide, and it extends to thousands of LGB fans who contribute ideas and suggestions and questions every day of every week of every year.

In between, many, many friends—advisors, designers, photographers, printers and more—worked long and hard to make this book a reality. Throughout the process, Johannes, Rolf and Wolfgang Richter supported this project and demonstrated their family's commitment to support their customers. Also, *LGB Telegram* magazine deserves special thanks for providing a wealth of photographs and graphics.

Some of the people who worked on this project are listed here, but there are many more who are not. (For example, many of the photographs used in this book were borrowed from the Lehmann archives, and the original sources for many of those photos are unclear or unknown.)

This book is dedicated to everyone involved in the making of this book...and to everyone who makes the World of LGB such an interesting place.



David Buffington, Editor

Illustrators:	Herbert Creutz Norbert Klenhart Uli Knauer Jim Massara J. Craig Thorpe
Text Editor:	Joann Britt
Translator:	Jan Heine
Engineering Advisor:	Heinz Koopmann
Technical Advisors:	Barbara Abler Albrecht Biedenbacher Drew Marshall Jonathan Meador Rainer Michel
Consumer Advisory Group:	Barbara Abler Richard Abler Gregory Martin Murray Milligan Tony Polson Zbigniew Struzik
Proofreaders:	Al Lorence Wolfgang Richter
Printer:	Druckerei W. Pfahler GmbH

Errors & Omissions

We have made our best effort to make this guide as accurate as possible. Still, we can and do make mistakes. If you find an error or omission we would like to know about it so we can correct the mistake in future editions.

To report an error or omission, please write:
Buffington Associates
PO Box 332
Hershey, PA 17033
USA



Index

<i>Product Number...</i>	<i>Page Number</i>	
00290...	209	
00550...	1	
00559...	1	
10000...	26-27, 30-31, 42-43, 45, 47-49, 71, 73, 107, 215	
10001...	45, 78	
10003...	45, 78	
10005...	45, 47, 78	
10010...	56, 152	
10040...	42, 47, 49-50, 56	
10050...	43, 47, 50, 56	
10070...	43, 47, 49, 56	
10080...	43, 47, 50, 56	
10090...	43, 47, 151	
10150...	30-31, 43, 47-48, 56, 75, 107, 215	
10151...	46-48, 99, 110, 122	
10152...	46-48, 107, 110, 114, 122, 126, 130	
10153...	35, 46-48, 107-108, 114, 120, 134, 215	
10154...	46-47, 136, 176	
10210...	75	
10220...	75	
10250...	76	
10260...	33, 109-110, 126	
10310...	76	
10320...	46-47, 76	
10520...	27, 145, 173-174, 215	
10560...	34, 46-48, 136, 174	
10600...	43, 47, 71	
10610...	43, 47, 156	
11000...	26-27, 30-32, 42-43, 45, 47-50, 71, 78, 107, 150, 215	
11020...	43, 47, 107	
11040...	43, 47	
11152...	46-47, 107, 114, 126	
11500...	66, 110	
12000...	26-27, 30, 42-43, 45, 47-50, 215	
12010...	34-35, 45, 86, 110-112, 114-118, 121, 124-125, 127, 130, 135-136, 161-163, 167, 179, 215	
12030...	35, 110, 113-118, 121, 124-125, 127, 130-131, 134-135, 162-163, 166-167, 174, 179, 215	
12040...	111	
12050...	45, 47, 50	
12100...	26-27, 30, 45, 47, 113, 215	
12150...	45, 47, 50	
12260...	43, 45, 47, 50, 143	
12360...	45, 47, 50, 162	
13000...	30, 38, 43, 45, 47, 49, 143, 215	
13100...	45, 47	
14000...	150	
15000...	30, 32, 43, 47, 49, 71, 78, 80, 150, 215	
16000...	43, 45, 47, 50, 71	
16050...	45, 47	
16150...	45, 47	
17010...	111, 117	
17100...	88-90, 110-114, 117-118, 121, 124, 127, 130, 132-133, 135, 161-162, 165-166	
19901...	26-28, 76, 215	
19902...	26-28, 215	
20570...	92	
20582...	92	
20670...	13, 103, 205-206	
20680...	4, 72	
20851...	207	
20882...	13	
21355...	72	
21602...	98	
21881...	209	
21900...	13, 103	
28001...	13	
40560...	176	
41610...	13, 46	
50010...	23, 72, 202-203, 205, 215	
50019...	202-204	
50020...	37, 97, 202, 215	
50040...	72, 202, 205	
50050...	205	
50060...	84-85, 90, 92, 136	
50061...	84-85, 90, 92, 136	
50070...	84-85, 91, 165	
50080...	85	
50081...	85	
50100...	13, 85, 88, 92, 111	
50101...	85, 89, 92	
50105...	90	
50110...	84, 92, 97-98, 113, 136	
50111...	84, 92, 97-98, 113, 136	
50121...	85, 91	
50130...	34, 86, 215	
50131...	86	
50140...	34, 86, 215	
50160...	86, 106	
50161...	86, 106	
50300...	130	
50310...	177	
50320...	177-178, 186	
50330...	176	
50340...	48, 176	
50350...	179	
50360...	179	
50500...	179	
50520...	76	
50550...	179	
50600...	73	
50610...	73	
50611...	73	
50612...	73	
50613...	73	
50614...	73	
50720...	86	
50730...	86	
50910...	129-130, 134, 177	
50920...	129-130, 136	
50940...	129-130	
50950...	130	
50960...	130	
51010...	77, 202	
51020...	208	
51080...	84, 136	
51081...	84, 136	

51120...85, 91-93
 51230...86, 106
 51750...34-35, 46, 79, 91, 110-115,
 117, 125, 130-131, 133-
 134, 136, 165-166, 174,
 176, 215
 51800...34, 91, 109, 112, 114-115,
 145, 162, 165, 179, 215
 52750...79, 112-114, 136, 165
 53750...111-112, 150, 154, 161,
 165-166
 55000...13, 98
 55010...98-99
 55020...98, 100-102
 55026...98, 102-103
 55100...98
 56200...171
 56201...169
 56202...171
 56203...169, 171
 56204...169, 171
 56300...75, 171
 56400...169-170
 56401...169-170
 56402...169
 64192...173
 64402...173
 64462...75
 64540...175
 67267...206
 67403...72, 180
 68331...180
 68332...180
 68333...180
 68334...180
 68502...180
 70301...13
 80090...72
 90013...84

Subject...Page Number
 bridge...59, 73, 76, 80-81, 107, 123,
 151, 153, 170, 182, 193
 catenary...13, 17, 73-76, 99, 108,
 168-172, 176, 184-185,
 212
 clearance...48, 67, 73, 76, 130, 159,
 164, 170
 coupler...37, 75, 173-175
 design...3, 41, 58, 67, 70, 94, 109,
 123, 126, 138-141, 144,
 151
 EPL...3, 5, 16, 33-34, 45, 79, 86,
 96, 99, 105-106, 110-115,
 120, 122, 127, 129-132,
 134-136, 138, 149, 152,
 160-162, 165, 167, 179,
 185, 203-204
 expansion set...26
 grade...63, 70-72, 74, 100, 142,
 153, 156-157, 177-178,
 182-183, 193, 206

 layout
 indoor...13, 16-17, 59, 64-
 66, 85, 91-92, 138-140,
 150, 157, 169, 184, 186
 modular...68-69
 outdoor...13, 16-17, 22, 34,
 39, 59, 61, 64-65, 73, 77,
 79-80, 90-92, 94, 138-140,
 150, 169, 188, 197, 202,
 205, 212
 oval...21, 26-27, 30, 33, 36,
 49, 53-55, 57, 79, 118,
 122, 126, 138, 141, 143,
 149-151, 154-155, 167,
 190-191
 point-to-point...27, 51-52,
 54-55, 72, 121-122, 139,
 143, 145, 154
 shelf...16, 58, 67, 138
 two-train...32, 49, 148, 150-
 151
 maintenance...3, 56, 65, 73, 79, 138-
 140, 202-205
 multi-train system...3, 5, 12-13, 33,
 83-84, 92, 95-104, 111,
 120-121, 125, 134, 139,
 147, 152, 156, 159, 172,
 212
 operations...5, 19, 27-28, 31, 52,
 139, 143-145, 149-150,
 157-159, 164, 175, 184,
 187, 193
 overhead wiring...see catenary
 plants...5, 59, 61, 64, 77, 142, 186,
 192, 197-200
 pulling power...37, 71-72
 rack railway...74-75
 radius...17, 32, 42-46, 50, 59, 67,
 72, 76, 78, 138, 182
 reversing loop...35-36, 46, 55, 101,
 110, 122-125, 149, 154,
 156, 182
 signal...34-35, 76, 101, 111, 113,
 129-136, 145-147, 149-
 150, 162-164, 166, 177-
 178, 186, 203-204
 starter set...3, 5, 13, 21-22, 24-28,
 30, 37, 57, 106, 109, 138,
 179
 track cleaning...13, 72, 103, 139,
 202, 205-206
 tunnel...58-59, 73-74, 76, 81, 123,
 139, 153-154, 193
 uncoupler...27, 34, 46, 48, 136, 143,
 145, 173-174

